

# **EtherXtend 3400 Series User's Guide**

**For software version 1.14.2**

September 2008

Document Part Number: 830-01831-04



Z H O N E <sup>TM</sup>

Zhone Technologies  
@Zhone Way  
7001 Oakport Street  
Oakland, CA 94621  
USA  
510.777.7000  
[www.zhone.com](http://www.zhone.com)  
[info@zhone.com](mailto:info@zhone.com)

**COPYRIGHT C2000-2008 Zhone Technologies, Inc. and its licensors. All rights reserved.**

This publication is protected by copyright law. No part of this publication may be copied or distributed, transmitted, transcribed, stored in a retrieval system, or translated into any human or computer language in any form or by any means, electronic, mechanical, magnetic, manual or otherwise, or disclosed to third parties without the express written permission from Zhone Technologies, Inc.

Bitstorm, EtherXtend, IMACS, MALC, MXK, Raptor, SLMS, Z-Edge, Zhone, ZMS, zNID and the Zhone logo are trademarks of Zhone Technologies, Inc.

Zhone Technologies makes no representation or warranties with respect to the contents hereof and specifically disclaims any implied warranties of merchantability, non infringement, or fitness for a particular purpose.

Further, Zhone Technologies reserves the right to revise this publication and to make changes from time to time in the contents hereof without obligation of Zhone Technologies to notify any person of such revision or changes.

# CONTENTS

<b>About This Guide</b> .....	9
<b>Style and notation conventions</b> .....	9
Typographical conventions.....	9
<b>Acronyms</b> .....	10
<b>Related documents</b> .....	11
<b>Contacting Global Service and Support</b> .....	11
Technical support.....	12
Service requirements.....	12
<b>Chapter 1 EtherXtend 3400 Overview</b> .....	13
<b>Product models</b> .....	14
<b>Product description</b> .....	14
<b>Technology description</b> .....	15
<b>EFM media</b> .....	16
<b>Ethernet services</b> .....	17
<b>Chapter 2 Safety, Regulations, and Certifications</b> .....	19
<b>Grounding and isolation</b> .....	19
<b>Installation safety precautions</b> .....	19
Important safety instructions.....	20
EMI notices.....	22
Canada - EMI notice.....	22
ACTA customer information.....	22
Supplier's declaration of conformity.....	24
Notice to Users of the Canadian Telephone Network.....	25
CE marking.....	25
Contacting Global Service and Support.....	25
Technical support.....	25
Service requirements.....	26

<b>Chapter 3</b>	<b>Features and Capabilities .....</b>	<b>27</b>
	<b>Ethernet in the first mile (EFM) overview .....</b>	<b>27</b>
	<b>2BASE-TL .....</b>	<b>27</b>
	<b>Zhone EFM features .....</b>	<b>28</b>
	PME aggregation .....	28
	Loop bonding .....	29
	<b>EtherXtend 3400 bonding implementation .....</b>	<b>30</b>
	One Ethernet port mapped to one SHDSL port .....	30
	One Ethernet port mapped to an SHDSL bonded group.....	31
	Ethernet ports mapped to different SHDSL bonded groups .....	31
	Multiple Ethernet ports mapped to multiple SHDSL ports .....	32
	<b>Scenarios .....</b>	<b>32</b>
	Endpoint-to-endpoint CPEs .....	32
	Multiple endpoints to multiple cards on a chassis .....	33
	CO mode with subtended devices .....	34
	<b>Product specifications .....</b>	<b>35</b>
	Specifications for the ETHX-SHDSL-4 .....	35
	Specifications for the ETHX-SHDSL-8 .....	36
<b>Chapter 4</b>	<b>Installation Preparation.....</b>	<b>37</b>
	<b>Tools you need.....</b>	<b>37</b>
	<b>Selecting the system location.....</b>	<b>37</b>
	<b>Environmental specifications .....</b>	<b>38</b>
	<b>Power requirements and specifications.....</b>	<b>38</b>
<b>Chapter 5</b>	<b>EtherXtend 3400 Installation.....</b>	<b>39</b>
	<b>Unpacking the system.....</b>	<b>39</b>
	<b>Port and LED descriptions .....</b>	<b>40</b>
	EtherXtend 3400 rear panel ports .....	40
	LED descriptions .....	40
	LED states for the EtherXtend 3400.....	41
	<b>Connect the power supply .....</b>	<b>42</b>
	<b>Connect the WAN SHDSL lines .....</b>	<b>43</b>
	Establish a loop bonded connection.....	43
	Connect the LAN Ethernet line.....	43
	<b>Ground the device .....</b>	<b>46</b>
<b>Chapter 6</b>	<b>Basic Configuration.....</b>	<b>47</b>
	<b>Device management .....</b>	<b>47</b>
	EtherXtend 3400 local management interface.....	48
	EtherXtend 3400 remote management interfaces .....	48

	<b>EtherXtend 3400 auto-provisioning</b> .....	51
	<b>Customize the EtherXtend 3400 default settings</b> .....	55
	<b>System settings</b> .....	58
	System security .....	58
	Changing the default user password.....	58
	Radius support .....	59
	System logging.....	63
	<b>Device interface</b> .....	63
	<b>LAN interfaces to CPEs</b> .....	64
	<b>Moving PC cables on Ethernet ports</b> .....	64
	<b>Configure an IP interface on an Ethernet port</b> .....	65
	<b>IP on a bridge</b> .....	68
<b>Chapter 7</b>	<b>EtherXtend 3400 SHDSL WAN Interfaces</b> .....	71
	<b>WAN SHDSL interfaces</b> .....	71
	Set pme-profile settings .....	71
	Set a region.....	72
	Set auto-negotiate or a data rate .....	72
	Set automatic baud rate adaption and fixed rate settings .....	73
	Set dsl-config profile settings .....	74
	Specify dsl-config settings .....	75
	Verify the interface.....	76
	Configure efm-port settings .....	77
	Set EFM connect rate .....	78
	<b>EtherXtend 3400 EFM 802.3ah bonding</b> .....	79
	Create bond groups .....	79
	Display bond groups .....	80
	Change bond group type .....	80
	Delete bond groups .....	81
	<b>Bond group/physical line stats</b> .....	81
	Packet counts .....	81
	Bond group bandwidth .....	82
<b>Chapter 8</b>	<b>EtherXtend 3400 Bridge Configuration</b> .....	83
	<b>Bridging overview</b> .....	83
	<b>Bridge enhancements to flood unknowns and multicasts</b> .....	86
	FloodUnknown parameter .....	86
	FloodMulticast parameter .....	87
	<b>Broadcasts and bridging</b> .....	88
	<b>VLANS</b> .....	88
	<b>Bridging behavior for untagged, tagged, and s-tagged</b> .....	92
	Overview .....	92

Untagged bridging examples .....	93
Tagged and s-tagged bridging examples.....	95
Bridge profile.....	96
<b>Q-in-Q VLAN tagging .....</b>	<b>98</b>
<b>Advanced bridging configurations .....</b>	<b>99</b>
Packet-rule records (Option 82, Forbid OUI, DHCP relay) .....	100
VLAN ID stripandInsert parameter .....	102
Broadcast suppression.....	103
Bridge with DHCP relay .....	104
<b>Class of Service (CoS) in bridges .....</b>	<b>106</b>
<b>Bandwidth limiting by port and service .....</b>	<b>107</b>
Color blind rate limiting.....	107
Configure color blind policing.....	108
Color aware rate limiting .....	109
Configure color aware policing.....	109
<b>Verifying bridge settings .....</b>	<b>110</b>
<b>EtherXtend 3400 CO and CPE mode bridge scenarios .....</b>	<b>112</b>
Bridges on EtherXtend 3400 CPE mode .....	112
Configure TLS bridges.....	112
Configure uplink and downlink bridges.....	113
EtherXtend 3400 CO mode with subtended EtherXtend 3400s in CPE mode.....	115
Configure the EtherXtend 3400 in CO mode.....	115
Configure the EtherXtend 3400 in CPE mode .....	117
<b>EtherXtend 3400 bridge commands .....</b>	<b>118</b>
Bridge delete command .....	118
Bridge show command .....	119
Bridge stats.....	119
<b>Chapter 9 EtherXtend 3400 Advanced Configuration .....</b>	<b>121</b>
<b>View EtherXtend 3400 statistics .....</b>	<b>121</b>
<b>EtherXtend 3400 bond group statistics .....</b>	<b>123</b>
View bond group statistics.....	123
View alarm activity.....	124
View individual member of bond group statistics .....	125
Set alarm thresholds.....	126
<b>Display EFM profile parameters .....</b>	<b>127</b>
Display EFM information .....	127
<b>Perform EFM updates.....</b>	<b>128</b>
Update the EFM port profile.....	128
Update the EFM bond.....	129
<b>Modify EFM port interfaces.....</b>	<b>129</b>
Perform a list command.....	129
EFM port default.....	129
Modify an EFM port .....	130
Create a new EFM bond group .....	130

<b>802.3ah EFM OAM</b> .....	130
OAM modes.....	131
Active mode .....	132
Passive mode .....	132
OAM commands.....	132
Add OAM to a bridge interface.....	132
Display OAM statistics .....	133
Show the OAM profile .....	133
<b>Chapter 10 IP Service Level Agreement</b> .....	137
<b>Overview</b> .....	137
<b>IPSLA</b> .....	137





# ABOUT THIS GUIDE

This guide is intended for use by EtherXtend 3400 users and administrators. EtherXtend 3400 users should have a fundamental knowledge of DSL protocols, Ethernet, and IP concepts.

Refer to the *EtherXtend Quick Start Guide* for hardware installation and connection information.

## Style and notation conventions

The following conventions are used in this document to alert users to information that is instructional, warns of potential damage to system equipment or data, and warns of potential injury or death. Carefully read and follow the instructions included in this document.



**Caution:** A caution alerts users to conditions or actions that could damage equipment or data.

---



**Note:** A note provides important supplemental or amplified information.

---



**Tip:** A tip provides additional information that enables users to more readily complete their tasks.

---



**WARNING!** A warning alerts users to conditions or actions that could lead to injury or death.

---



**WARNING!** A warning with this icon alerts users to conditions or actions that could lead to injury caused by a laser.

---

## Typographical conventions

The following typographical styles are used in this guide to represent specific types of information.

<b>Bold</b>	Used for names of buttons, dialog boxes, icons, menus, profiles when placed in body text, and property pages (or sheets). Also used for commands, options, parameters in body text, and user input in body text.
Fixed	Used in code examples for computer output, file names, path names, and the contents of online files or directories.
<b>Fixed Bold</b>	Used in code examples for text typed by users.
<b>Fixed Bold Italic</b>	Used in code examples for variable text typed by users.
<i>Italic</i>	Used for book titles, chapter titles, file path names, notes in body text requiring special attention, section titles, emphasized terms, and variables.
PLAIN UPPER CASE	Used for environment variables.
Command Syntax	Brackets [ ] indicate optional syntax. Vertical bar   indicates the OR symbol.

## Acronyms

The following acronyms are related to the EtherXtend 3400 and will appear throughout this manual:

<b>Acronym</b>	<b>Description</b>
AAL2	ATM Adaption Layer 2
CAS	Channel Associated Signaling
CID	AAL2 Channel Identifier
CLI	Command Line Interface
CO	Central Office
CPE	Customer Premises Equipment
dB	Decibel
DSL	Digital Subscriber Line
DSLAM	Digital Subscriber Line Access Multiplexer
DSS1	Digital Subscriber Signaling System number 1
EFM	Ethernet First Mile
ELCP	Emulated Loop Control Protocol
G.SHDSL	Global Symmetrical High-bit-rate Digital Subscriber Line

Acronym	Description
IANA	Internet Assigned Numbers Authority
Kbps	Kilobytes per second
LAN	Local Area Network
MALC	Zhone Multi-Access Loop Concentrator
MIB	Management Information Base
NAT	Network Address Translation
PMA	Physical Medium Attachment
PMD	Physical layer, media dependent
PME	Physical Medium Entities
SDSL	Symmetric Digital Subscriber Line
SHDSL	Single pair high speed Digital Subscriber Line
SNMP	Simple Network Management Protocol
TDM	Time Division Multiplexing
TFTP	Trivial File Transfer Protocol
VCI	Virtual Channel Identifier
VCL	Virtual Channel Link
VPI	Virtual Path Identifier
WAN	Wide Area Network

## Related documents

Refer to the following publications for additional information:

- *EtherXtend 3400 Quick Start Guide*
- *EtherXtend 3400 Release Notes*

## Contacting Global Service and Support

Contact Global Service and Support (GSS) if you have any questions about this or other Zhone products. Before contacting GSS, make sure you have the following information:

- Zhone product you are using
- System configuration
- Software version running on the system

- Description of the issue

## Technical support

If you require assistance with the installation or operation of your product, or if you want to return a product for repair under warranty, contact GSS. The contact information is as follows:

E-mail	<a href="mailto:support@zhone.com">support@zhone.com</a>
Telephone (North America)	877-ZHONE20
Telephone (International)	510-777-7133
Internet	<a href="http://www.zhone.com/support">www.zhone.com/support</a>

If you purchased the product from an authorized dealer, distributor, Value Added Reseller (VAR), or third party, contact that supplier for technical assistance and warranty support.

## Service requirements

If the product malfunctions, all repairs must be performed by the manufacturer or a Zhone-authorized agent. It is the responsibility of users requiring service to report the need for service to GSS.

# 1

## ETHERXTEND 3400 OVERVIEW

This chapter discusses the following topics describing the EtherXtend 3400:

- [Product models on page 14](#)
- [Product description, page 14](#)
- [Technology description, page 15](#)
- [EFM media, page 16](#)
- [Ethernet services, page 17](#)

The EtherXtend 3400 devices are next-generation Ethernet-enabled customer premises equipment (CPE). EtherXtend 3400 provides 4-port and 8-port models that perform the functions of a network extender by lengthening the reach of Ethernet packets. The EtherXtend 3400 allows Ethernet packets to pass over existing copper wires that link the service provider (a central office, street cabinet, pole, or tower) to a subscriber's CPE. This distance is known as Ethernet in the First Mile (EFM). EFM is a set of specifications that allow users to run Ethernet protocols over previously unsupported media such as single pairs of copper wires in subscriber access networks. EtherXtend 3400 EFM is covered by IEEE standard 802.3ah.

## Product models

Table 1 provides the model numbers for the EtherXtend 3400 products.

**Table 1: EtherXtend 3400 models**

Model Name	Description
ETHX-3444-US	4-port SHDSL EFM device running on alternating current for US power requirements.
ETHX-3444-UK	4-port SHDSL EFM device running on alternating current for United Kingdom power requirements.
ETHX-3444-EU	4-port SHDSL EFM device running on alternating current for European Union power requirements.
ETHX-3444-DC	4-port SHDSL EFM device running on direct current power requirements.
ETHX-3484-US	8-port SHDSL EFM device running on alternating current for US power requirements.
ETHX-3484-UK	8-port SHDSL EFM device running on alternating current for United Kingdom power requirements.
ETHX-3484-EU	8-port SHDSL EFM device running on alternating current for European power requirements.
ETHX-3484-DC	8-port SHDSL EFM device running on direct current power requirements.

## Product description

The 4- and 8-port EtherXtend 3400 SHDSL Ethernet access devices deliver bonded high-speed EFM services over SHDSL. The ETHX-SHDSL-x device family provides 802.3ah compliant SHDSL bonding with advanced features, including Zhone's Multimedia Traffic Management (MTM). In addition, full compliance to 802.3ah industry standards provide high reliability, low latency, and integrated operation, administration, and maintenance (OAM) features for advanced management of Ethernet lines.

Figure 1: Rear view of the EtherXtend 3400 8-port device

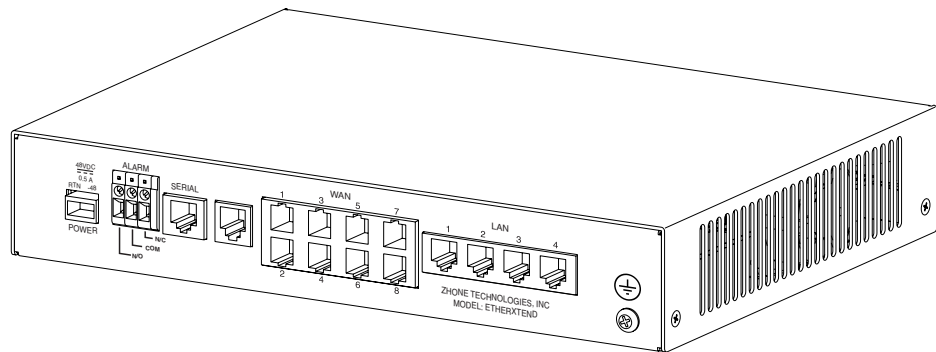
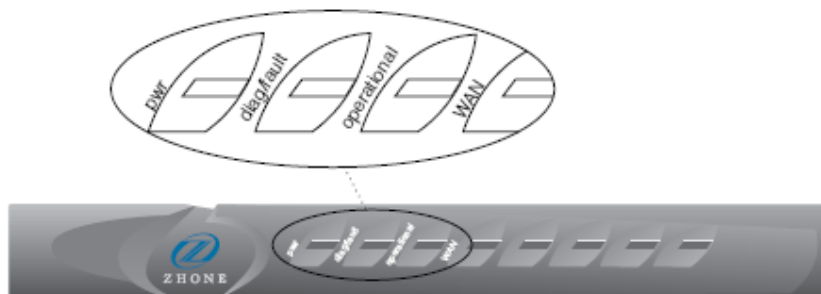

Figure 2: Front view of the LEDs on the EtherXtend 3400 device



With Zhone's proprietary lightweight Ethernet bonding technologies, EtherXtend 3400 provides dual-mode operations to allow EtherXtend 3400 to aggregate into standards-based products such as the MALC broadband loop carrier, and other EtherXtend-SHDSL-x units. The EtherXtend 3400 can also connect into pre-standard Ethernet loop bonding products such as Zhone's Ethernet access products.

## Technology description

EFM provides high performance for data traveling across a connection between the subscriber and the service provider. This connection has been a stopgap for Internet traffic, limiting performance to whatever the constraints of this connection are. Regardless of how fast data could travel over xDSL network links, the data usually would be slowed down on the last link connecting the subscriber to the service provider.

The EtherXtend 3400 provides an ideal solution for the following scenarios:

- LAN extensions in metro areas
- a cellular site backhaul

- any point-to-point application requiring Ethernet connectivity over the WAN

The EtherXtend 3400 can be used to create a point-to-point connection over a dry copper pair. Within a campus environment or multi-tenant unit (for example, a hospital) where the subscriber owns the cabling infrastructure, copper pairs are often available throughout the facility as unused telephone cabling.

Any cell site running EvDO CDMA or 3G provides an Ethernet interface for mobile applications such as mini-web browsing. Typically, these Ethernet ports are connected to a T1 router so they can be carried over long distances to the CO where they are terminated into Ethernet.

The EtherXtend 3400 platforms not only provide a more cost-effective alternative to deploying dedicated T1 router equipment at each cellular tower, but they also provide loop bonding capabilities to reach the higher bandwidth demands of EvDO and 3G.

The Ethernet port of the cell tower simply connects to the appropriate EtherXtend 3400 platform, and the Ethernet frames are transported directly to four SHDSL lines. At the CO, the extended LAN connection presents a single Ethernet interface for simple connectivity to the data network.

*Loop bonding* allows multiple physical lines to be grouped together to achieve higher data rates. For example, four 5.7 Mbps SHDSL lines can be combined to provide up to 20 Mbps of bandwidth. Loop bonding is an easy way to increase line speeds where extra copper is available.

The EtherXtend 3400 technology uses existing copper facilities to deliver high bandwidth Ethernet services over existing copper loops to business customers. Products from this technology are both EFM standards compliant and compatible with existing bonded copper solutions to deliver point-to-point Ethernet connectivity over the WAN.

The EtherXtend 3400 transports Ethernet directly over SHDSL, T1, or E1. This makes it easy to interconnect LANs over virtually any distance. These transparent LAN services allow businesses with broadly distributed remote offices to operate as if located on the same local network.

## EFM media

Copper wire access lines are the dominant access media today. While optical fiber facilities are gaining market share, the existing media (copper) still is more dominant in terms of volume of footage, number of entry points, and number of regions governed by a technology type.

EFM over copper services offers more than fiber class speed. They support a wide range of applications and opportunities. EFM technology provides benefits for installations provisioning high-speed, high-value services and for users of those services who realize cost and performance improvements delivered rapidly and flexibly.



EFM over copper applications include:

- Frame Relay migration to E-LAN services
- T1/E1 replacement with E-Line services, including internet access, wireless backhaul, voice access, and wholesale services.
- Transparent LAN service (TLS)

EFM over copper technology supports a wide range of voice, data, and video services and applications. Many applications are extensions of those now supported by T1/E1 and Frame Relay services. However, they are more responsive to new demands by customers by providing much higher data rates.

## Ethernet services

The Metro Ethernet Forum (MEF) has helped to define standards for Ethernet services. These standards helped to establish the user network interface and Ethernet virtual connection for two principal services: E-Line and E-LAN.

*E-Line services* include point-to-point Ethernet connections using Layer 2 VLAN infrastructure with two types of user network interface (UNI) access: 802.1Q-in-802.1Q (QinQ) and dot1Q encapsulation. These services are also known as Ethernet Relay Service (ERS) and Ethernet Wire Service (EWS).

*E-LAN services* provide multipoint-to-multipoint services using virtual private LAN services (VPLS) or simply layer 2 VLAN core.

Carrier Ethernet has developed a series of extensions to standard Ethernet that provide improved performance on the Internet.



# 2

## SAFETY, REGULATIONS, AND CERTIFICATIONS

This chapter discusses the following topics on how to prepare your site for the installation of the EtherXtend 3400 platform:

- [Grounding and isolation, page 19](#)
- [Installation safety precautions on page 19](#)
- [EMI notices, page 22](#)
- [ACTA customer information, page 22](#)
- [Supplier's declaration of conformity, page 24](#)
- [CE marking, page 25](#)
- [Contacting Global Service and Support, page 25](#)
- [Technical support, page 25](#)
- [Service requirements, page 26](#)

### Grounding and isolation

The EtherXtend 3400 uses an integrated frame and logic ground system as follows:

- The EtherXtend 3400 device and logic ground are bonded.
- Cable shielding is terminated on the EtherXtend 3400 system device ground.

When the AC plug is not grounded, it is recommended to ground the device using minimum 16-gauge wire to a building or earth ground.

### Installation safety precautions

Avoid creating a hazardous condition by maintaining even weight distribution within the device.

Maximum operating temperature should not exceed 65<sup>0</sup>C (149<sup>0</sup>F). Observe the maximum recommended operating temperature as indicated here.

Do not block system air vents; this will deprive the system of the airflow required for proper cooling. Sufficient clearance must exist on all sides of the rack to permit equipment access. Connect the system to the power supply circuit as described in this document. Do not overload the system or power supply circuit. Ensure that proper system grounding is performed and maintained.

## Important safety instructions

### **Read and follow all warning notices and instructions marked on the product or included in the manual.**

- 1** Slots and openings in the product are provided for ventilation. To ensure reliable operation of the product and to protect it from overheating, these slots and openings must not be blocked or covered.
- 2** Do not allow anything to rest on the power cord and do not locate the product where persons will walk on the power cord.
- 3** Do not attempt to service this product yourself, as opening or removing covers may expose you to hazardous voltage or to other risks. Refer all servicing to qualified service personnel.
- 4** General purpose cables are used with this product for connection to the network. Special cables, which may be required by the regulatory inspection authority for the installation site, are the responsibility of the customer. Use a UL Listed, CSA certified (or a cable that is certified in the country in which it is being installed), minimum No. 26 AWG (.163mm<sup>2</sup>) line cord for connection to the Digital Subscriber Line (DSL) network.
- 5** When installed, the product must comply with the applicable Safety Standards and regulatory requirements of the country in which it is installed. If necessary, consult with the appropriate regulatory agencies and inspection authorities to ensure compliance.
- 6** A rare phenomenon can create a voltage potential between the earth grounds of two or more buildings. If products installed in separate buildings are interconnected, the voltage potential may cause a hazardous condition. Consult a qualified electrical consultant to determine whether or not this phenomenon exists and, if necessary, implement corrective action prior to interconnecting the products.
- 7** When using a certified class II transformer/Input power to this product must be provided with one of the following: (1) a NRTL certified power source with a Class 2 output for use in North America, or (2) a certified power source, with a Safety Extra Low Voltage (SELV) output having a maximum of 240 VA available, for use in the country of installation.

Figure 3: AC feed power connection

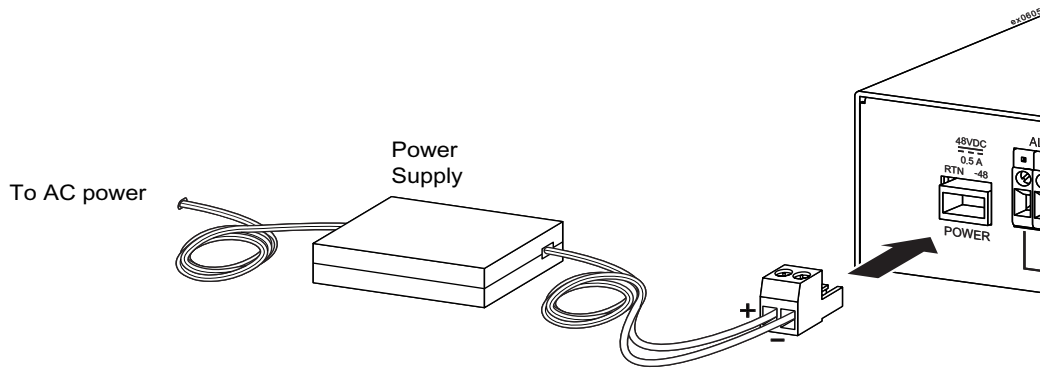

For DC direct feed operation: Connect the 48 VDC SELV supply source that is electrically isolated from the AC source. Use Stranded 18 AWG (1.045mm<sup>2</sup>) gauge wire, type SPT or HO3 wire. The length may vary up to a maximum of 6 feet. All conductors on both ends of the wire should be stripped back .25 inches, but not tinned. Use [Figure 4](#) as a guide to wire the two-wire terminal provided. The 48 VDC source is to be reliably connected to earth. Ground by attaching an earthing ground wire to the Sem Screw Zhone P/N 150-00071-01 (8-32 x 1/2 split lock steel screw) provided on the rear panel of the chassis next to the earth ground symbol. The wire should be a minimum of 14 AWG (2.7 mm<sup>2</sup>) grounding conductor with insulation colored green with a yellow strip and should connect to a copper grounding lug Heyco P/N 1851 (Zhone P/N 170-02880-01) or equivalent. The copper ground lug will connect to grounding screw terminal located on the back of the EtherXtend 3400 chassis next to the earth ground symbol.

Figure 4: DC feed power connection

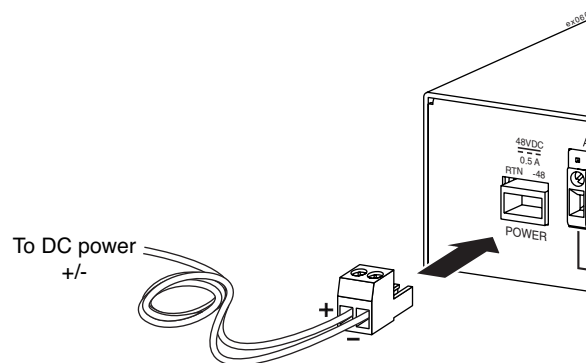

In addition, since the equipment is to be used with telecommunications circuits, take the following precautions:

- Never install telephone wiring during a lightning storm.
- Never install telephone jacks in wet locations unless the jack is specifically designed for wet locations.
- Never touch uninsulated telephone wires or terminals unless the telephone line has been disconnected at the network interface.
- Use caution when installing or modifying telephone lines.
- Avoid using a telephone (other than a cordless type) during an electrical storm. There may be a remote risk of electric shock from lightning.
- Do not use the telephone to report a gas leak in the vicinity of the leak.

## EMI notices

The following are EMI notices for the United States.

This equipment has been tested and found to comply with the limits for a Class A digital device, pursuant to Part 15 of the FCC rules. These limits are designed to provide reasonable protection against harmful interference when the equipment is operated in a commercial environment. This equipment generates, uses, and can radiate radio frequency energy and, if not installed and used in accordance with the instruction manual, may cause harmful interference to radio communications. Operation of this equipment in a residential area is likely to cause harmful interference in which case the user will be required to correct the interference at his own expense.

The authority to operate this equipment is conditioned by the requirements that no modifications will be made to the equipment unless the changes or modifications are expressly approved by Zhone Technologies, Inc.

If the equipment includes a ferrite choke or chokes, they must be installed as described in the installation instructions.

## Canada - EMI notice

This Class A digital apparatus complies with Canadian ICES-003.

Cet appareil numérique de la classe A est conforme à la norme NMB-003 du Canada.

## ACTA customer information

This equipment complies with Part 68 of the FCC rules and the requirements adopted by the ACTA. On the bottom of the network extender is a label that contains, among other information, a product identifier in the format US:AAAEQ##TXXXX. If requested, this number must be provided to the telephone company.

A plug and jack used to connect this equipment to the premises wiring and telephone network must comply with the applicable FCC Part 68 rules and requirements adopted by the ACTA. See installation instructions for details.

If the network extender causes harm to the telephone network, the telephone company will notify you in advance that temporary discontinuance of service may be required. But if advance notice isn't practical, the telephone company will notify the customer as soon as possible. Also, you will be advised of your right to file a complaint with the FCC if you believe it is necessary.

The telephone company may make changes in its facilities, equipment, operations or procedures that could affect the operation of the equipment. If this happens the telephone company will provide advance notice in order for you to make necessary modifications to maintain uninterrupted service.

If trouble is experienced with this equipment, please contact your local sales representative, service representative, or distributor directly for any help needed. For additional information concerning warranty, sales, service, repair, installation, documentation, training, distributor locations, or Zhone Technologies worldwide office locations, contact Global Service and Support.

If the equipment is causing harm to the telephone network, the telephone company may request that you disconnect the equipment until the problem is resolved.

The customer may make no repairs to the equipment.

Connection to party line service is subject to state tariffs. Contact the state public utility commission, public service commission or corporation commission for information.

## Supplier's declaration of conformity

Place of Issue: Zhone Technologies

8545 126th Avenue North

Largo, FL 33773-1502

USA

Date of Issue: July 10, 2006

Zhone Technologies, located at the above address, hereby certifies that the Model ETHX-SHDSL-X (where X = 4 or 8 denoting the total number of WAN ports) bearing labeling identification number US:6RTDLNANETHX complies with: the Federal Communications Commission's ("FCC") Rules and Regulations 47 CFR Part 68, and the Administrative Council on Terminal Attachments ("ACTA")-adopted technical criteria TIA-968-A, "Telecommunications - Telephone Terminal Equipment - Technical Requirements for Connection of Terminal Equipment To the Telephone Network, October 2002," as amended by TIA-968-A-1, TIA-968-A-2 and TIA-968-A-3.

A handwritten signature in black ink, appearing to read "Keith Nauman". The signature is fluid and cursive, with a long horizontal stroke at the end.

Keith Nauman  
Vice President



## Notice to Users of the Canadian Telephone Network

NOTICE: This equipment meets the applicable Industry Canada Terminal Equipment Technical Specifications. This is confirmed by the registration number. The abbreviation IC before the registration number signifies that registration was performed based on a Declaration of Conformity indicating that Industry Canada technical specifications were met. It does not imply that Industry Canada approved the equipment.

NOTICE: The Ringer Equivalence Number (REN) for this terminal equipment is labeled on the equipment. The REN assigned to each terminal equipment provides an indication of the maximum number of terminals allowed to be connected to a telephone interface. The termination on an interface may consist of any combination of devices subject only to the requirement that the sum of the Ringer Equivalence Numbers of all the devices does not exceed five.

If your equipment is in need of repair, contact your local sales representative, service representative, or distributor directly.

## CE marking

When the product is marked with the CE mark on the equipment label, a supporting Declaration of Conformity may be downloaded from the Zhone World Wide Web site at [www.zhone.com](http://www.zhone.com).

## Contacting Global Service and Support

Contact Global Service and Support (GSS) if you have any questions about this or other Zhone products. Before contacting GSS, make sure you have the following information:

- Software version running on the system
- System configuration
- Zhone product you are using
- Description of the issue

## Technical support

If you require assistance with the installation or operation of your product, or if you want to return a product for repair under warranty, contact GSS.

**Table 2: Contact information**

E-mail	<a href="mailto:support@zhone.com">support@zhone.com</a>
Telephone (North America)	877-ZHONE20
Telephone (International)	510-777-7133

**Table 2: Contact information (Continued)**

<b>E-mail</b>	<b>support@zhone.com</b>
Internet	www.zhone.com/support

If you purchased the product from an authorized dealer, distributor, Value Added Reseller (VAR), or third party, contact that supplier for technical assistance and warranty support.

## **Service requirements**

If the product malfunctions, all repairs must be performed by the manufacturer or a Zhone-authorized agent. It is the responsibility of users requiring service to report the need for service to GSS.

# 3

## FEATURES AND CAPABILITIES

This chapter discusses topics describing EtherXtend 3400 EFM functionality for use in subscriber access networks:

- [Ethernet in the first mile \(EFM\) overview, page 27](#)
- [2BASE-TL on page 27](#)
- [Zhone EFM features, page 28](#)
- [EtherXtend 3400 bonding implementation, page 30](#)
- [Scenarios, page 32](#)
- [Product specifications, page 35](#)

### Ethernet in the first mile (EFM) overview

Ethernet in the First Mile (EFM), is a collection of protocols (IEEE 802.3ah) for Ethernet access and management technology across both the copper and fiber network infrastructure.

Principally, EFM technology was established to enhance subscriber access networks and provides the following benefits:

- Ethernet interfaces and transport over previously unsupported media, such as single pairs of telephone copper wires
- A universal Ethernet service extending the reach of Ethernet to locations served by both copper and fiber
- A consistent set of Ethernet services with adjustable bandwidth and rates from 1 Mbps to 10 Gbps.

### 2BASE-TL

EFM over Copper (EFMC) is a point-to-point Ethernet over copper standard targeted at small to medium enterprise sites served by copper. The two protocols associated with EFM are: 2BASE-TL and 10PASS-TS. Zhone currently supports only 2BASE-TL. The following table provides details about 2BASE-TL.

Table 3: 2BASE-TL protocol

Protocol	Point Method	Standard	Media	Mode	Data Rate	Distance	Bonding
2BASE-TL	Point-to-Point	SHDSL	Copper	Symmetric	1 - 5.7 Mbps	2,700 meters	32 pairs; 8 pairs (actual)

2BASE-TL is based on the SHDSL standard for symmetric DSL services. The data rates over a single copper pair range between 1 Mbps and 5.7 Mbps. 2BASE-TL can serve distances up to 2,700 meters. Theoretically, up to 32 copper pairs can be bonded together to increase data rates and resiliency. In practice, no more than 8 pairs are bonded.

The standard closely resembles the SHDSL specification for the PMA and PMD sublayers. The PMA sublayer consists of a framer/deframer and a scrambler/descrambler. The PMA sublayer then sends a framed and scrambled bit stream to the PMD layer for modulation over the single copper pair.

The PMD sublayer first passes the bit stream through a convolutional encoder/decoder and then through the PCM modulator/demodulator. The PMD sublayer then passes electrical signals across a single pair of voice grade copper lines.

## Zhone EFM features

This section discusses EtherXtend 3400 equipment enhancements:

- [PME aggregation on page 28](#)
- [Loop bonding on page 29](#)

## PME aggregation

Physical Medium Entities (PME) aggregation uses *frame fragmentation* to divide, load balance, and transmit MAC frames across up to 32 parallel links.

Frame fragmentation is used so that MAC frames are broken up into smaller pieces and sent in parallel across multiple links. This increases effective throughput while minimizing latency and jitter across the bonded links.

Fragment sizes must be between 64 and 512 bytes and must be multiples of 64 bytes. All fragments must be at least 64 bytes long. The algorithm for fragmenting MAC frames is left up to the implementer so there can be differences in performance between different vendors in transmitting data across bonded links.

## Loop bonding

Ethernet loop bonding refers to a technology where multiple physical SHDSL lines are grouped together to provide greater bandwidth potential over a single logical connection. The WAN connection terminates into a single Ethernet connection, providing a single connection to the end user.

However multiple lines aggregate on the WAN to provide higher bandwidth. This enables carriers to provide greater distances for higher bandwidth services, for example, IP television, VoIP, and other converged services.

In DSL loop bonding, two or four copper pairs are utilized to yield up to 8x the bandwidth at any given distance. This allows extremely long local loops to deliver high-speed DSL. For example, while SHDSL only supports 144 Kbps at 25,000 feet, four SHDSL lines together would provide 576 Kbps or just over .5 Mbps. The loop bonding aspect of the connection is invisible to the consumer who realizes an increase in access speed.

The following table shows the data rates that bonded loops can produce.

**Table 4: Selected data rates (in Kbps) realized through bonding loops**

Distance (feet)	CO-to-CPE (1 Pair)	CO-to-CPE (2 Pair)	CO-to-CPE (4 Pair)	CO-to-CPE (8 Pair)
5,000	5,704	11,408	22,816	45,632
7,000	5,704	11,408	15,936	28,800
9,000	3,856	5,792	9,536	18,560
12,000	2,192	4,384	7,488	10,368
15,000	1,040	2,080	3,392	5,248
18,000	464	928	1,856	3,200

While the total achievable distance is not increased through loop bonding, the maximum bandwidth that can be achieved at any distance is increased, making even very long DSL deployments capable of high data rates.

## EtherXtend 3400 bonding implementation

This section provides details on various implementations of EtherXtend 3400:

- [One Ethernet port mapped to one SHDSL port on page 30](#)
- [One Ethernet port mapped to an SHDSL bonded group on page 31](#)
- [Ethernet ports mapped to different SHDSL bonded groups on page 31](#)
- [Multiple Ethernet ports mapped to multiple SHDSL ports on page 32](#)

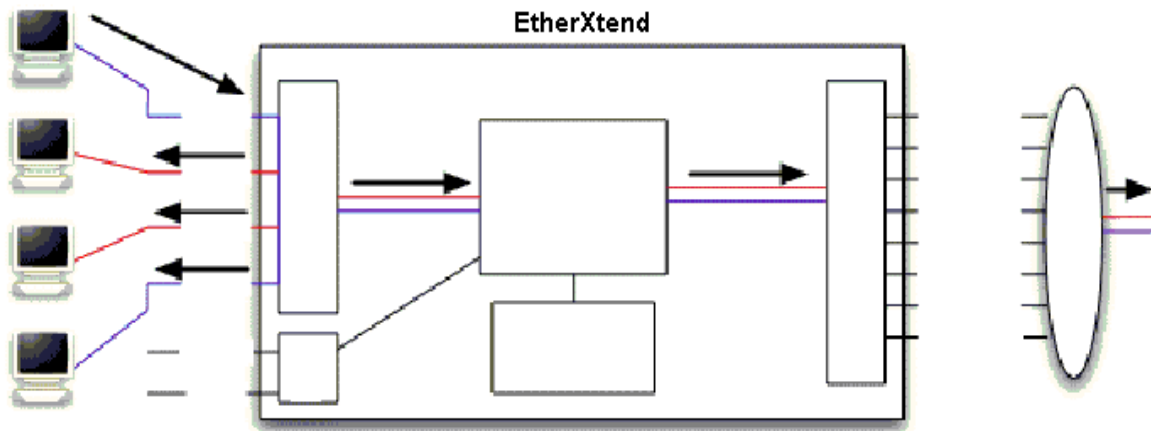

Unicast traffic destined for remote (SHDSL) ports will not be forwarded to other local Ethernet ports. However, in wire mode, packets are not processed by SLMS code within the NPU; they are cut-through to the SHDSL ports directly.

### One Ethernet port mapped to one SHDSL port

This configuration is a simple LAN extension application. In this mode, the device is simply a bridge. Backhaul from a cell tower might use this configuration. Instead of an Ethernet to T1 conversion, this approach would allow native Ethernet throughout the network.

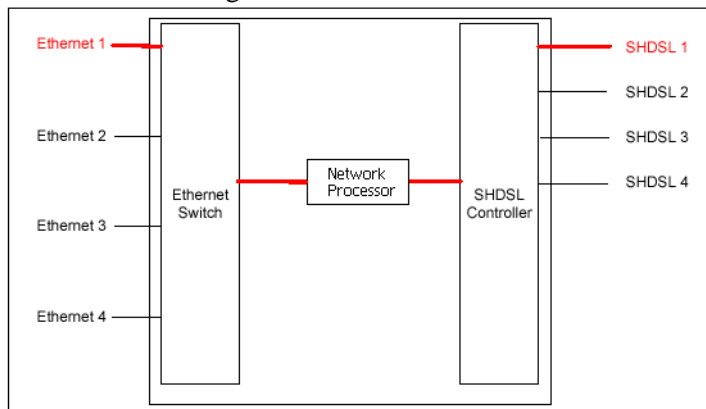

## One Ethernet port mapped to an SHDSL bonded group

This configuration increases the speed of the WAN link. This configuration applies to the same scenarios as the instance where one Ethernet port is mapped to one SHDSL port. However, you use this scenario when there is a need for greater bandwidth. With two ports bonded together, you can raise your throughput to 11.4 Mbps. This is appropriate for bursty LAN traffic because the Ethernet port support throughput at 100 Mbps and the DSL port supports throughput at 11 Mbps.

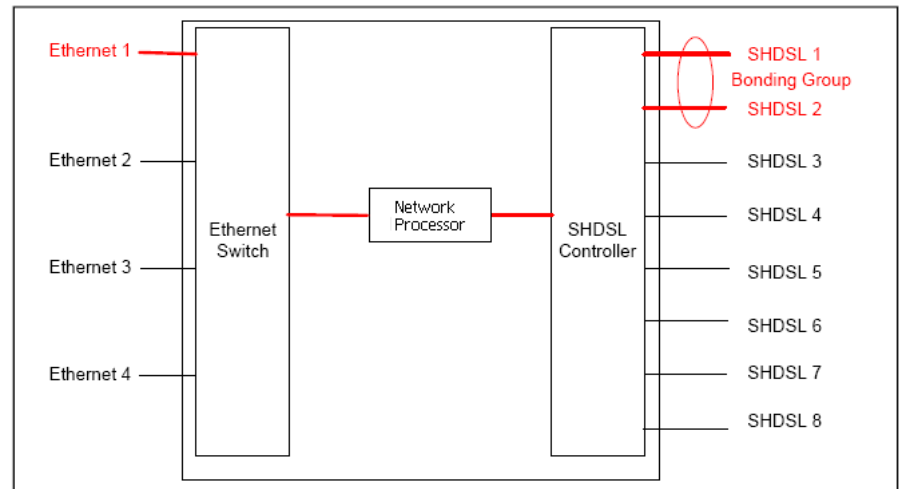

## Ethernet ports mapped to different SHDSL bonded groups

In this configuration, two independent Ethernet ports are connected to different bonded SHDSL groups. This configuration operates as two Ethernet extenders in the same physical unit. This feature allows for transparent LAN services. It could be possible for Company A to use Ethernet port 1 and Company B to use Ethernet port 3. With features such as Plans, the traffic from each company would be separated. A better solution could be to use just two units. Then the data is physically as well as logically separated.

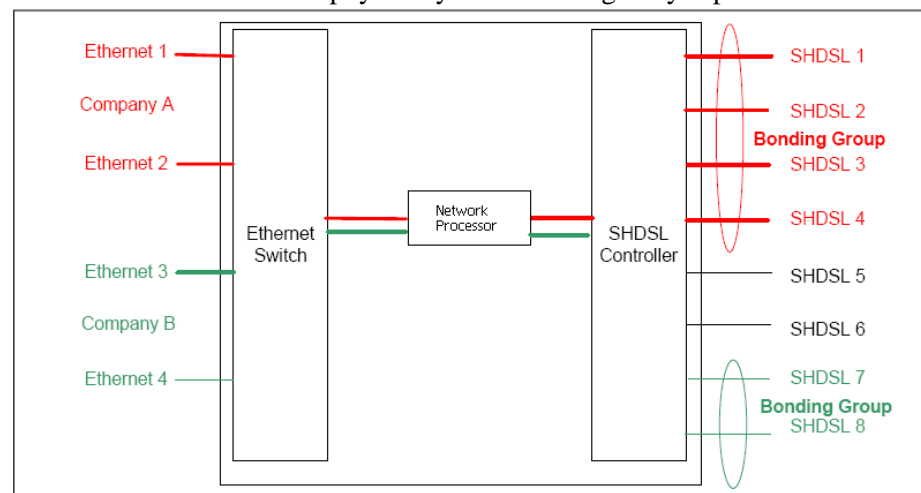

## Multiple Ethernet ports mapped to multiple SHDSL ports

This configuration allows multiple PCs to connect to the EAD eliminating the need for an additional router or switch for multiple users. In addition, the WAN link speed is significantly improved. This configuration is similar to the scenario where multiple Ethernet switch ports map to one SHDSL port. However, the WAN link speed is much faster. with all eight ports bonded, the WAN speed can be up to 45 Mbps.

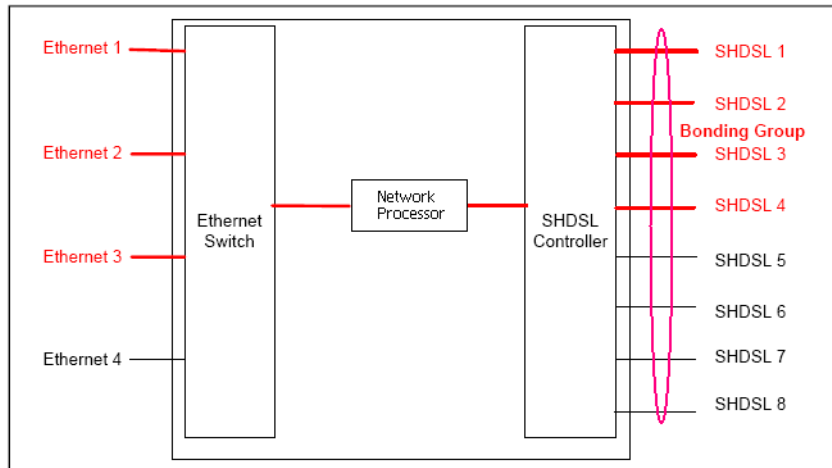

## Scenarios

This section provides details on possible usage scenarios for the EtherXtend 3400 device:

- [Endpoint-to-endpoint CPEs on page 32](#)
- [Multiple endpoints to multiple cards on a chassis on page 33](#)
- [CO mode with subtended devices, page 34](#)

### Endpoint-to-endpoint CPEs

The basic scenario is a pair of EtherXtend 3400 devices acting as endpoints. This pairing is where an explicit endpoint is directly connected to another explicit endpoint. This topology is known as back-to-back mode. The following figure details this.

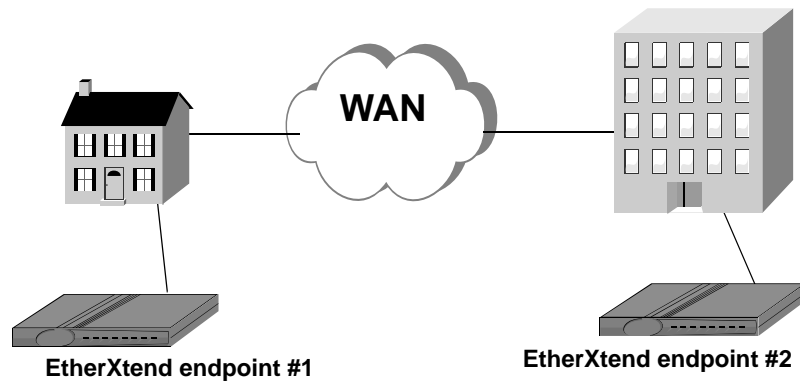
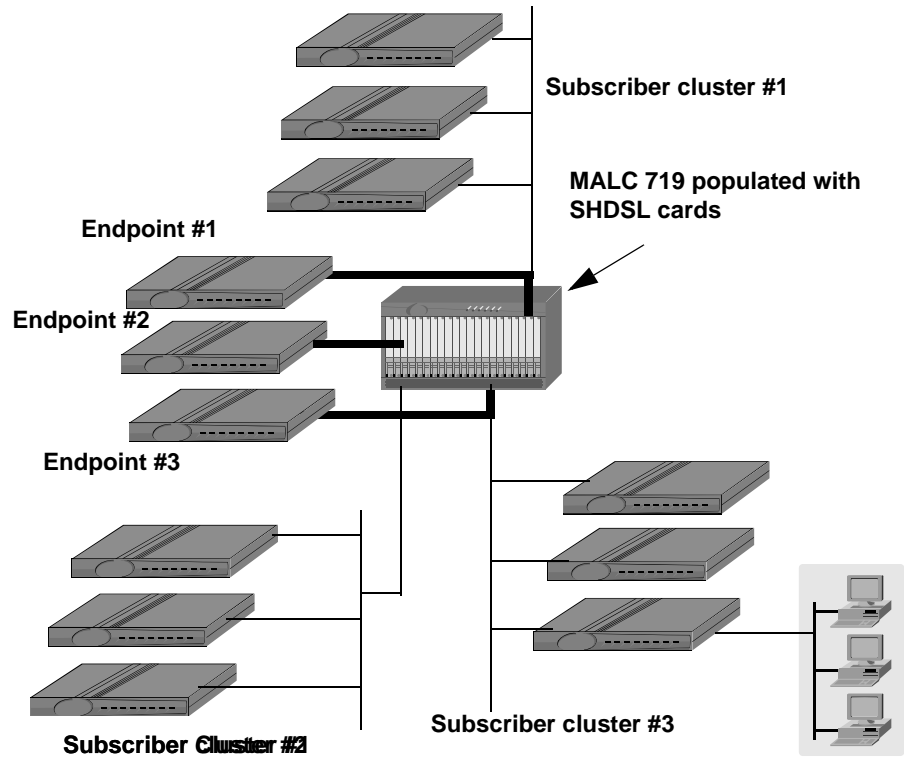

**Figure 5: EtherXtend 3400 in back-to-back mode**

## Multiple endpoints to multiple cards on a chassis

This scenario enables the most subscribers. This scenario is multiple EtherXtend 3400 endpoints connecting to multiple SHDSL cards in a chassis. Each card has 24 ports and can connect to multiple endpoints on the subscriber side. The following figure shows three EtherXtend 3400 endpoints connecting to a MALC containing three SHDSL cards. Each of those cards connects to three subscribers side EtherXtend 3400 endpoints, each with four ports.

Figure 6: Multiple endpoints connecting to multiple SHDSL cards on a MALC



## CO mode with subtended devices

In this scenario, one EtherXtend 3400 device functions in CO as the aggregation point to the network, while other EtherXtend 3400 devices are subtended in various locations and connected to CPEs.

Figure 7: EtherXtend 3400 in CO mode

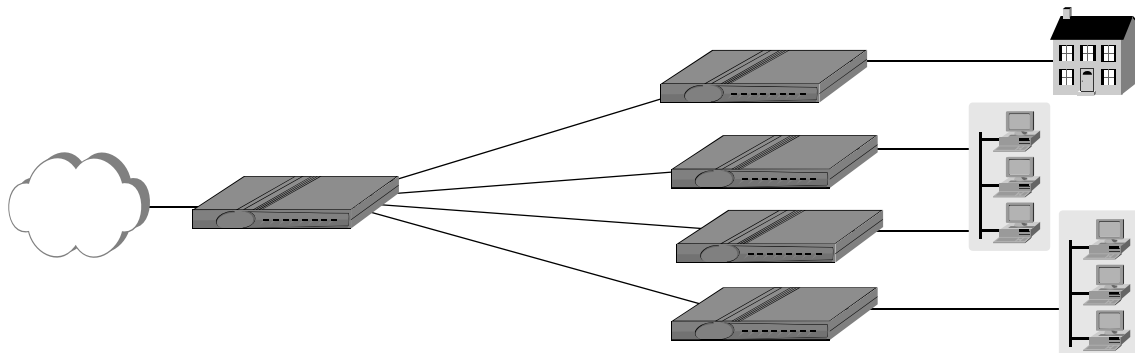

## Product specifications

Table 5 and Table 6 provide product specifications for the ETHX-SHDSL-4 and ETHX-SHDSL-8.

### Specifications for the ETHX-SHDSL-4

**Table 5: ETHX-SHDSL-4 specifications**

Specification Type	Specification
Dimensions	1.75" (4.45 cm) High x 10" (21.6 cm) Wide x 7.5" (19.1 cm) Deep
Weight	3.35 lbs (1.52 kg)
Power	-48V DC and Universal AC power options available.
Interfaces	4 extended-rate SHDSL (2Base-TL) interfaces; 4 10/100 Ethernet interfaces.
Standards Support	ITU G.994.1 G.handshake; IEEE 802.3 Ethernet; IEEE 802.3ah Ethernet in the First Mile (2Base-TL); IEEE 802.3ah OAM, IEEE 802.1Q/p.
Protocol Support	Host-based routing for per-interface single IP address assignments; network-based routing for per-interface IP subnet address assignments; IP host and gateway support; RFC 1483/2684 Encapsulation; VLAN 802.1Q support.
Management	Serial terminal and Telnet for command line interface; inband IP via 10/100 Ethernet or WAN port.
Bandwidth/Distance	Data rates up to 5.7 Mbps symmetrical; distances up to 24,000 ft/7,320m; cross-talk cancellation within bonded groups.
Operating Requirements	Temperature: 32 <sup>0</sup> F to 149 <sup>0</sup> F (0 <sup>0</sup> C to 65 <sup>0</sup> C); Non-operating temperature: -40 <sup>0</sup> F to 185 <sup>0</sup> F (-40 <sup>0</sup> C to 85 <sup>0</sup> C); humidity: 5% to 95%, non-condensing; altitude: -200 ft. to 16,500 ft. (-60m to 5,000m).

## Specifications for the ETHX-SHDSL-8

**Table 6: ETHX-SHDSL-8 specifications**

Specification Type	Specification
Dimensions	1.75" (4.45 cm) High x 10" (21.6 cm) Wide x 7.5" (19.1 cm) Deep
Weight	3.35 lbs (1.52 kg)
Power	-48V DC and Universal AC power options available.
Interfaces	8 extended-rate SHDSL (2Base-TL) interfaces; 4 10/100 Ethernet interfaces.
Standards Support	ITU G.994.1 G.handshake; IEEE 802.3 Ethernet; IEEE 802.3ah Ethernet in the First Mile (2Base-TL); IEEE 802.3ah OAM, IEEE 802.1Q/p.
Protocol Support	Host-based routing for per-interface single IP address assignments; network-based routing for per-interface IP subnet address assignments; IP host and gateway support; VLAN 802.1Q support.
Management	ZMS via SNMPv2c for GUI and CORBA IDL machine interface; serial terminal and Telnet for command line interface; inband IP via 10/100 Ethernet or WAN port.
Operating Requirements	Temperature: 32 <sup>0</sup> F to 149 <sup>0</sup> F (0 <sup>0</sup> C to 65 <sup>0</sup> C); Non-operating temperature: -40 <sup>0</sup> F to 158 <sup>0</sup> F (-40 <sup>0</sup> C to 70 <sup>0</sup> C); humidity: 5% to 95%, non-condensing; altitude: -200 ft. to 16,500 ft. (-60m to 5,000m).

# 4 INSTALLATION PREPARATION

This chapter discusses topics on how to prepare your site for the installation of the EtherXtend 3400 platform:

- [Tools you need, page 37](#)
- [Selecting the system location, page 37](#)
- [Environmental specifications, page 38](#)
- [Power requirements and specifications, page 38](#)

## Tools you need

The required equipment listed in [Table 7](#) should be available before beginning the installation of the EtherXtend 3400 system.

**Table 7: Equipment required to install the EtherXtend 3400 system**

Qty	Equipment	Details	Use
1	VT-100-compatible terminal or PC used as a VT-100 terminal emulator	Connected to the EtherXtend 3400 through RJ45 craft port.	Commission and configuration
1	Pliers		General installation
1	Cable prep tools	Pressfit and crimpers	Cable installation
-	Cables		System connections
2	#1 and #2 Phillips-head and 1/8-inch flat-blade screwdrivers	N/A	Locking and unlocking cards, front panels and chassis brackets
2	Antistatic wrist strap	N/A	Static electricity prevention

## Selecting the system location

Ensure that the environment is free of dust and excessive moisture, not exposed to the elements or temperature extremes, and has sufficient ventilation.

Install the system in reasonable proximity to all equipment with which it will connect. Ensure that proper cable grades are used for all system and network connections. For best results, use the cables and connectors recommended in this document.

## Environmental specifications

Table 8 describes the EtherXtend 3400 chassis environmental specifications and shows the EtherXtend 3400 dimensions.

**Table 8: EtherXtend 3400 environmental specifications**

Description	Specification
Weight	3.35 lbs. (1.52 kg) fully loaded
Operating temperature	0 <sup>0</sup> C to +65 <sup>0</sup> C (32 <sup>0</sup> F to +149 <sup>0</sup> F).
Storage temperature	0 <sup>0</sup> C to +65 <sup>0</sup> C (32 <sup>0</sup> F to +149 <sup>0</sup> F)
Operating relative humidity	5% to 95% noncondensing
Storage relative humidity	Up to 95% noncondensing
Altitude	Operating altitude: Up to 4,000 m (13,123 ft.)
Airflow	EtherXtend 3400 (working at front of unit): Left to right

## Power requirements and specifications

–48V DC power sources to be connected to the EtherXtend 3400 system. The Return (+) terminals are common.

Table 9 describes the EtherXtend 3400 power specifications.

**Table 9: EtherXtend 3400 power supply specifications**

Description	Specification
Rated voltage	-41.75V to -60.0V DC
Maximum power consumption	EtherXtend 3400: 4-port watts, 19.4 watts EtherXtend 3400 8-port watts, 19.4 watts
DC-input cable	AWG 18 (5.27 mm <sup>2</sup> ) maximum

# 5

## ETHERXTEND 3400 INSTALLATION

This chapter discusses how to prepare your site for the installation of the EtherXtend 3400 platform:

- [Unpacking the system, page 39](#)
- [Port and LED descriptions, page 40](#)
- [Connect the power supply, page 42](#)
- [Connect the WAN SHDSL lines, page 43](#)
- [Ground the device, page 46](#)

### Unpacking the system

Use the following procedure to unpack the EtherXtend 3400 system components from the shipping cartons.

- On system receipt, check the shipping cartons for physical damage.
- Unpack the shipping cartons, and check the contents for physical damage.
- If the equipment appears damaged, immediately contact the shipping company to file a claim.

The shipping company representative will give instructions on how to submit a claim, where to send the unit, and any special instructions that may be required.

If you need to return the equipment, pack the equipment in its original packing materials and send it by prepaid freight to the address given by the claims representative. If the original packing materials are unavailable, ship the equipment in a sturdy carton, wrapping it with shock-absorbing material.

## Port and LED descriptions

This section provides descriptions of the ports on the rear panel of the EtherXtend 3400:

- [EtherXtend 3400 rear panel ports on page 40](#)
- [LED descriptions on page 40](#)
- [LED states for the EtherXtend 3400 on page 41](#)

### EtherXtend 3400 rear panel ports

The following graphic shows where the ports are located.

Figure 8: Location of rear panel ports

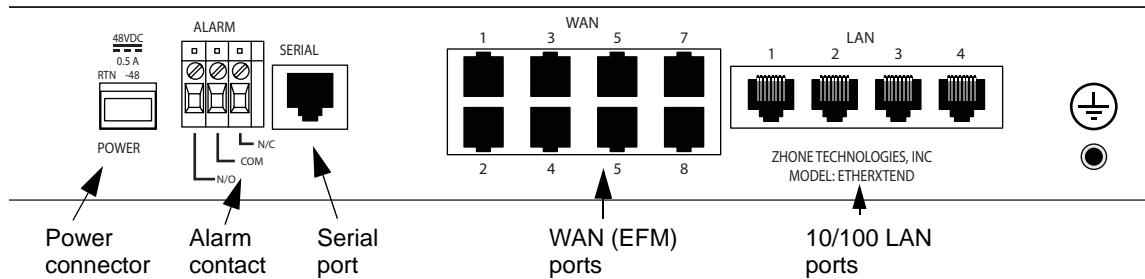

Table 10: Description of rear panel ports

Port	Description	Type	Speed/Protocol
Serial	Enables a serial modem connection for establishing out-of-band management sessions from outside of the network.	RJ-45	9600 Bps/RS-232
WAN (SHDSL)	Enables a SHDSL connection.	RJ-45	5,696 Kbps
10/100	Enables a Fast Ethernet connection. Four 10/100 ports.	RJ-45	10 Mbps/Ethernet 100 Mbps/Ethernet

### LED descriptions

This section describes the EtherXtend 3400 LEDs.

The two types of LEDs found on the EtherXtend 3400 are:

- **Status LEDs** Located on the front of the device to show system-wide states
- **Port LEDs** Located in the ports on the back of the device to show the states that exist for a specific port, for example the status of a link connection.



The following table describes the both the system and port LEDs that appear on EtherXtend 3400. The LED port lights are located on the port.

**Figure 9: LEDs on the EtherXtend 3400 device**

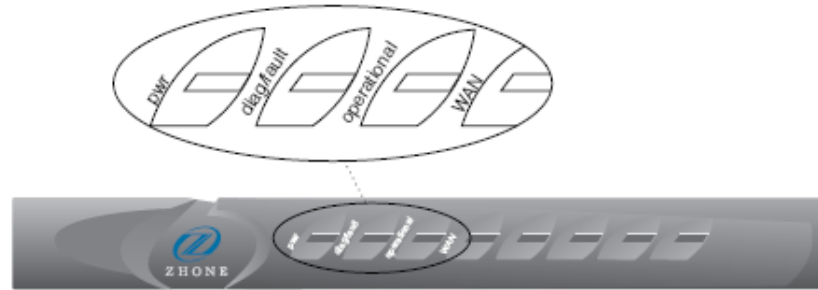

## LED states for the EtherXtend 3400

The state of the LEDs show how the device is operating. [Table 11](#) describes the LED states.

**Table 11: LED states on the EtherXtend 3400**

LED	LED Color	Solid/Blinking	Meaning of the LED
Power	green	solid	Battery voltage is within tolerance.
Diagnostics	amber	blinking	Occurs during the Post process if any alarms are present.
Operational	green	blinking	Device is initializing.
WAN	green	solid	Indicates whether any activity occurs on the EFM ports or in Data mode. Training has occurred. Speed negotiation has occurred.
WAN (SHDSL) (Left) - Port State	green	solid	The port link state is up.
		off	None of the ports are in data mode.
		blinking	The port link state is down.
LAN (10/100) (left side)	green	solid	The port links to the network.
		off	The port does not link to the network.
		blinking	The port has activity occurring on it.

**Table 11: LED states on the EtherXtend 3400 (Continued)**

LED	LED Color	Solid/Blinking	Meaning of the LED
LAN (10/100) (right side)	green	off	The port operates in 10BASE-T mode where it transmits and receives packets at 10Mbps.
		on	The port operates in 100BASE-T mode where it transmits and received packets at 100Mbps.

## Connect the power supply

Connect the power supply to the EtherXtend 3400 by plugging either the AC power supply or the DC power supply into the power adaptor port on the back of the device. The power adaptor port has a plus (+) and a minus (-). The plus side connects to the RTN side of the power outlet and the minus side connects to the -48 side of the power outlet. Verify that the power LED on the front of the device illuminates. After startup, Ethernet links remain disabled until at least one of the SHDSL connection has been established. [Figure 10](#) shows the AC power supply.

**Figure 10: Connect AC power**

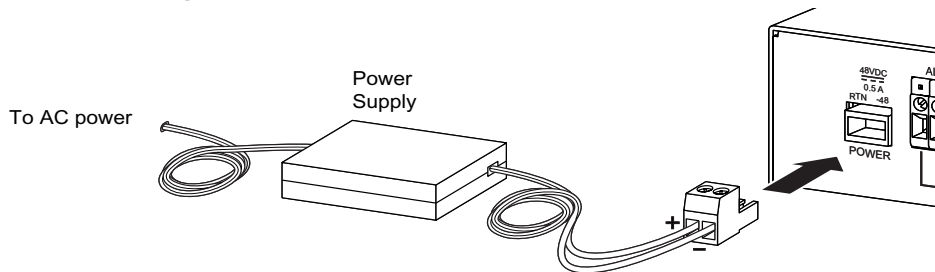

[Figure 11](#) shows a DC power connection.

**Figure 11: Connect DC power**

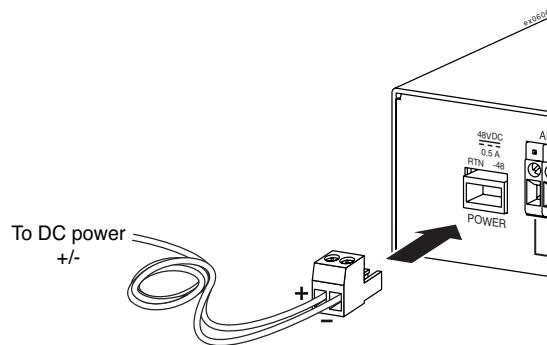

## Connect the WAN SHDSL lines

This section discusses establishing a loop bonded connection and connecting the LAN Ethernet line:

- [Establish a loop bonded connection on page 43](#)
- [Connect the LAN Ethernet line on page 43](#)

### Establish a loop bonded connection

Using up to eight SHDSL lines for one network connection (loop bonding) will net up to eight times the speed and data passing capability as a single SHDSL connection. Multiple SHDSL lines used for one connection provide backup for each other should one or more of the lines become disabled.

#### Establishing a loop bonded connection

- 1 Plug your SHDSL cables into the SHDSL RJ-45 ports (any combination of SHDSL 1, 2, 3, and 4) on the rear of the device. The order of the connection is not important.
- 2 Verify the connections. The SHDSL link LED for each connected port flashes green when the connection is established and operational.

#### Establishing a single line connection

- 1 Plug your SHDSL cable into one of the four SHDSL RJ-45 ports on the back of the device. Any of the four ports may be used.
- 2 Verify your connection. The SHDSL LED corresponding to the connected port flashes green when the connection is established and operational.

When bonding is not needed, both the provider and the subscriber units can function with a single SHDSL connection.

### Connect the LAN Ethernet line

If an SHDSL connection has not yet been made, the Ethernet link remains disabled as indicated by no illumination of the LEDs until at least one of the four SHDSL lines are established.

The 10/100 Ethernet port auto-negotiates speed and duplex mode in accordance with the remote equipment to which it is connected.

- Half Duplex - Receive and transmit functions are mutually exclusive; data transmission occurs in only one direction at a time. Packet collisions are unusual.
- Full Duplex - Receive and transmit functions occur simultaneously, effectively doubling aggregate bandwidth and preventing packet collisions.

For the best connection results, the remote device should be set to autonegotiate speed and duplex mode as well. If the remote device cannot be configured to autonegotiate, speed may be hard set at either 10 Mbps or 100 Mbps. But duplex mode must be hard set to half duplex. A 10/100 Ethernet connection will not operate properly if the remote device is hard set to full duplex.

## Hard setting the speed and mode of an Ethernet port

In order to manually provision the speed and duplex of the Ethernet port, the autonegstatus must be set to disabled and any of the following values entered in the mauType field as shown in [Table 12](#):

**Table 12: mauType field values**

mauType	Setting
mauType = mau10basethd	10 Mbps half-duplex
mauType = mau10basetfd	10 Mbps full-duplex
mauType = mau100basethd	100 Mbps half-duplex
mauType = mau100basetfd	100 Mbps full-duplex

To change the speed and mode of the Ethernet port, enter the following commands:

- 1 To view the Ethernet port interfaces, enter **list ether**:

```
zSH> list ether
ether 1-1-1-0/eth
ether 1-1-2-0/eth
ether 1-1-3-0/eth
ether 1-1-4-0/eth
4 entries found.
```

- 2 To view the Ethernet port interface parameter defaults, enter **get ether interface/type**:

```
zSH> get ether 1-1-1-0/eth
ether 1-1-1-0/eth
autonegstatus: ----> {enabled}
mauType: -----> {mau100basetxfd}
restart: -----> {norestart}
ifType: -----> {mau100basetxfd}
autonegcap: -----> {b10baseT+b10baseTFD+b100baseTX+b100baseTXFD}
remotefault: -----> {noerror}
clksrc: -----> {automatic}
pauseFlowControl: -> {disabled}
```

- 3 To view the ether port interface parameter variables, enter **show ether**:

```
zSH> show ether
```

```

autonegstatus:---->  enabled  disabled
mauType:----->  mauother  mau10baset  mau10basethd  mau10basetfd  mau100basetxhd
  mau100basetxfd  mau1000baselxhd  mau1000baselxfd  mau1000basesxhd  mau1000basesxfd
  mau1000basethd  mau1000basetfd
restart:----->  restart  norestart
ifType:----->  mauother  mau10baset  mau10basethd  mau10basetfd  mau100basetxhd
  mau100basetxfd  mau1000baselxhd  mau1000baselxfd  mau1000basesxhd  mau1000basesxfd
  mau1000basethd  mau1000basetfd
autonegcap:----->  bOther+b10baseT+b10baseTFD+b100baseT4+b100baseTX+b100baseTXFD+b1
  00baseT2+b100baseT2FD+b1000baseX+b1000baseXFD+b1000baseT+b1000baseTFD+b100baseX+b1ba
  seXFD+b100baseT+b100baseTFD
remotefault:----->  noerror  offline  linkfailure  autonegerror
clksrc:----->  unused  automatic  master  slave
pauseFlowControl:->  disabled  asymmetricTx  asymmetricRx  symmetric

```

**4** To change the speed/mode of the Ethernet port, disable auto negotiate and change the mauType as follows using **update ether interface/type**:

**a** To set Ethernet port 1 to 10Mbps half-duplex enter:

```

zSH> update ether 1-1-1-0/eth
autonegstatus:---->{enabled}: disabled
mauType:----->{mau100basetxfd}: mau10basethd
Save changes? [s]ave, [c]hange or [q]uit: s

```

**b** To set Ethernet port 1 to 10Mbps full-duplex enter:

```

zSH> update ether 1-1-1-0/eth
autonegstatus:---->{enabled}: disabled
mauType:----->{mau100basetxfd}: mau10basetfd
Save changes? [s]ave, [c]hange or [q]uit: s

```

**c** To set Ethernet port 1 to 100Mbps half-duplex enter:

```

zSH> update ether 1-1-1-0/eth
autonegstatus:---->{enabled}: disabled
mauType:----->{mau100basetxfd}: mau100basetxhd
Save changes? [s]ave, [c]hange or [q]uit: s

```

**d** To set Ethernet port 1 to 100Mbps full-duplex enter:

```

zSH> update ether 1-1-1-0/eth
autonegstatus:---->{enabled}: disabled
mauType:----->{mau100basetxfd}: 100basetxfd
Save changes? [s]ave, [c]hange or [q]uit: s

```

**5** To set the Ethernet port 1 back to auto-negotiate enter:

```

zSH> update ether 1-1-1-0/eth
autonegstatus:---->{disabled}: enabled
mauType:----->{mau100basetxfd}: mau100basetxfd
Save changes? [s]ave, [c]hange or [q]uit: s

```

## **Ground the device**

When the AC plug is used, but not grounded it is recommended to ground the device using minimum 16-gauge wire to a building or earth ground. The ground screw is located on the far-right on the back of the device.

# 6 BASIC CONFIGURATION

This chapter discusses EtherXtend 3400 basic configuration:

- [Device management, page 47](#)
- [EtherXtend 3400 auto-provisioning, page 51](#)
- [Customize the EtherXtend 3400 default settings, page 55](#)
- [System settings, page 58](#)
- [Device interface, page 63](#)
- [LAN interfaces to CPEs, page 64](#)
- [Moving PC cables on Ethernet ports, page 64](#)
- [Configure an IP interface on an Ethernet port, page 65](#)
- [IP on a bridge, page 68](#)

## Device management

This section describes how the EtherXtend 3400 can be managed either through the serial interface or the WAN Ethernet ports:

- [EtherXtend 3400 local management interface on page 48](#)
- [EtherXtend 3400 remote management interfaces on page 48](#)

EtherXtend 3400 devices provide interfaces for four or eight WAN SHDSL ports, four LAN 10/100 Ethernet ports, and a serial port for local management.

After connecting the MALC Ethernet ports on a SHDSL card and the Ethernet WAN ports on the EtherXtend 3400, the default Autoconfig automatically configures the interface as a EFM bond group on VLAN 7 as a DHCP client.

[Table 13](#) lists the EtherXtend 3400 system default settings.

**Table 13: EtherXtend 3400 default system settings**

Parameter	Default setting
Mode	CPE Mode
IP Address	DHCP enabled on bond group port.

**Table 13: EtherXtend 3400 default system settings (Continued)**

Parameter	Default setting
SHDSL Speed	5,696 Adaptive
Ethernet Interface	Autosensing Enabled Autonegotiating Enabled
Bonding Mode	efm
Login	admin
Password	zhone
DHCP Client (WAN)	Enabled

## EtherXtend 3400 local management interface

The EtherXtend 3400 unit provides an out-of-band RS232 D serial (craft) interface to manage the unit locally. To access the serial port, configure the terminal interface software with the following settings:

- 9600bps
- 8 data bits
- No parity
- 1 stop bit
- No flow control

You must perform the initial configuration of the system using the serial (craft) interface. After completing the initial configuration, you can manage the EtherXtend 3400 device remotely through Telnet over the network through the Ethernet management interface or over the management PVC.



**Note:** The EtherXtend 3400 supports a maximum of two concurrent telnet sessions and one serial session.

## EtherXtend 3400 remote management interfaces

This section describes how the EtherXtend 3400 can be managed remotely from the MALC using the default management interface and how to change the management interface to manage the EtherXtend 3400 from a different IP address:

EtherXtend 3400 uses the *shelf-slot-port-subport/type* syntax to identify system interfaces. For the EtherXtend 3400, the convention is always 1 for the *shelf* and 1 for the *slot* value. The *subport* is always 0. The *type* is based on the Internet Assigned Numbers Authority interface type (IANAiftype) definitions.



By default, Autoconfig assigns a bond group number to the EFM bond group which may vary depending on which port receives the link first. The management interface is built on the default EFM bond group, `1-1-1-bondgroupnumber/efmbond`, as a DHCP client using VLAN 7.

## Managing EtherXtend 3400 using the default management interface

The MALC that connects to the EtherXtend 3400 can be configured as a local DHCP server or as a client with a bridge to an external DHCP server.

- 1 Configure Telnet access from the MALC to the EtherXtend 3400 by creating a new `dhcp-server-subnet 1` on the MALC, with the parameters displayed in the **dhcp-server-subnet** profile:

```
zSH> get dhcp-server-subnet 1
dhcp-server-subnet 1
network: -----> {10.250.1.0}
netmask: -----> {255.255.255.0}
domain: -----> {0}
range1-start: -----> {10.250.1.1}
range1-end: -----> {10.250.1.250}
range2-start: -----> {0.0.0.0}
range2-end: -----> {0.0.0.0}
range3-start: -----> {0.0.0.0}
range3-end: -----> {0.0.0.0}
range4-start: -----> {0.0.0.0}
range4-end: -----> {0.0.0.0}
default-lease-time: -----> {-1}
min-lease-time: -----> {-1}
max-lease-time: -----> {-1}
boot-server: -----> {0.0.0.0}
bootfile: -----> {}
default-router: -----> {10.250.1.254}
primary-name-server: ----> {0.0.0.0}
secondary-name-server: -> {0.0.0.0}
domain-name: -----> {}
subnetgroup: -----> {1}
stickyaddr: -----> {enable}
external-server: -----> {0.0.0.0}
```

- 2 Create the management interface on the MALC by entering **interface add float management 10.250.1.254.255.255.255.0**.

```
zSH> interface add float management 10.250.1.254.255.255.255.0
```

- 3 Enter **host add** on the MALC to configure a host connection between the EtherXtend 3400 and the bond group associated with the management interface:

```
zHS> host add 1-1-203-0/efmbond vlan 7 dynamic 1 1
```

You can now Telnet to the MALC and then Telnet to the EtherXtend 3400 device.

Refer to the MALC documentation for detailed procedures on DHCP configuration.

## Managing EtherXtend 3400 using a non-default management interface

To manage the EtherXtend 3400 through an interface different than the default AutoConfig address, delete the default AutoConfigIP address and then add the desired interface. If the new IP address is not compatible with the address of the management PC, the connection to the device will be lost. To restore the connection, change the address of the management PC to be compatible with the device address.

The following example configures the IP address for the system:

- 1 Delete the AutoConfig address.

```
zSH> delete ip-interface-record AutoConfig/ip
```

- 2 Add the desired interface to a bond port group.

```
zSH> interface add 1-1-4-0/n2nbond 172.24.200.133/24  
Created ip-interface-record ethernet1/ip
```



**Note:** The default interface is reset if a **set2default** is performed without the restore option.

---

## Verifying the interface

Enter **interface show** to verify that the Ethernet interface was configured correctly on the EtherXtend 3400:

```
zSH> interface show
1 interface
Interface      Status  Rd/Address          Media/Dest Address  IfName
-----
1/1/4/0/ip     UP      1 172.24.200.133/24  00:01:47:07:ef:ee  AutoConfig
-----
```

### Creating a default route

The following example creates a default route using the gateway 192.168.8.1 with a cost of 1 (one):

```
route add default 192.168.8.1 1
```

### Verifying the route

To verify that the routes were added, enter **route show**:

```
zSH> route show
Dest              Nexthop          Cost    Owner
-----
0.0.0.0/0         192.168.8.1     1       STATICLOW
192.168.8.1/24   1/1/1/0/ip      1       LOCAL
```

To verify connectivity to the default gateway, enter **ping**:

```
zSH> ping 192.168.10.1
PING 192.168.10.1: 64 data bytes
!!!!
----192.168.8.1 PING Statistics----
5 packets transmitted, 5 packets received
round-trip (ms)  min/avg/max = 0/0/0
```

To stop the ping, press CTRL+C.

## EtherXtend 3400 auto-provisioning

The auto-provisioning feature of the EtherXtend 3400 provides a factory default configuration of EtherXtend 3400 interfaces. Auto-provisioning runs during the initial boot of the EtherXtend 3400 or after entering a **set2default** command.



**Note:** In order not to run auto-provisioning and to use your own customized configuration settings, you must either have a *default* file or a *restore* file located in the *onreboot* directory. To create a *default* file see [Customize the EtherXtend 3400 default settings, page 55](#). To create a restore file see

During the initial EtherXtend 3400 boot, auto-provisioning automatically:

- Creates an efbond group, 1-1-99-0/efbond with all SHDSL interfaces as members.

- Adds a DHCP client interface using VLAN 7 on the bond group for device management over the WAN.
- Creates a TLS bridge for tagged VLAN traffic (VLAN 0) and a TLS bridge for untagged traffic on each of the four LAN Ethernet interfaces and the SHDSL efbond group.

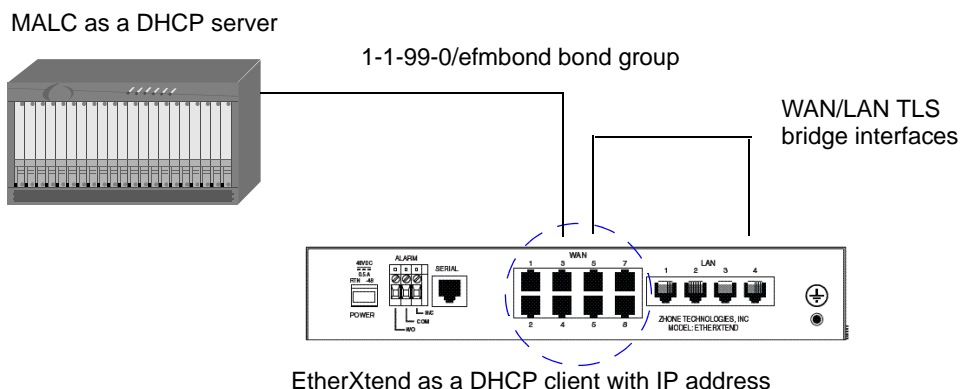

Auto-provisioning automatically runs when an EtherXtend 3400 is upgraded to a version of software that runs auto-provisioning from a version of the software that did not run auto-provisioning. When auto-provisioning runs after an upgrade, some of the existing configuration will be overwritten, specifically bridges and the IP interfaces.

Auto-configuration runs just once during the initial boot of the EtherXtend 3400 and runs once after a **set2default**. When upgrading the EtherXtend 3400 software from a version of the software that supports auto-provisioning, auto-provisioning does not run again except after using the **set2default** command.

For a description of how to create user-defined defaults and bypass EtherXtend 3400 auto-provisioning to factory defaults, see [Customize the EtherXtend 3400 default settings on page 55](#).

To verify the version of the software running on an EtherXtend 3400 enter **swversion**:

```
zSH> swversion
Zhone ethX3400 software version ETHX 1.14.2.119
```

To view the auto-provisioned configuration, enter **bridge show**:

```
zSH> bridge show
Type VLAN      Bridge                                     St  Table Data
-----
tls           7 1-1-99-0-efmbond/bridge                 UP
tls Tagged    1-1-99-0-efmbond-0/bridge                UP
tls           7 1-1-1-0-eth/bridge                       DWN
tls Tagged    1-1-1-0-eth-0/bridge                     DWN
tls           7 1-1-4-0-eth/bridge                       DWN
tls Tagged    1-1-4-0-eth-0/bridge                     DWN
```

```

tls          7 1-1-3-0-eth/bridge          DWN
tls Tagged   1-1-3-0-eth-0/bridge        DWN
tls          7 1-1-2-0-eth/bridge          DWN
tls Tagged   1-1-2-0-eth-0/bridge        DWN
zSH>

```

To view the bond group and the members of the bond group, enter **bond show group interface/type**:

```

zSH> bond show group 1-1-99-0/efmbond
          Bond Groups
Slot  GrpId  Name          Type          State
  1     99   1-1-99-0     efmbond       ACT

          Group Members
Slot  Port   Name          Type          State
  1     3    1-1-3-0      shdsl         ACT
  1     2    1-1-2-0      shdsl         ACT
  1     1    1-1-1-0      shdsl         ACT
  1     8    1-1-8-0      shdsl         ACT
  1     7    1-1-7-0      shdsl         ACT
  1     6    1-1-6-0      shdsl         ACT
  1     5    1-1-5-0      shdsl         ACT
  1     4    1-1-4-0      shdsl         ACT

```

To verify the bond group interface enter **interface show**:

```

zSH> interface show
1 interface
Interface      Status  Rd/Address          Media/Dest Address  IfName
-----
1/1/99/0/ip    UP      1 0.0.0.0/0        00:01:47:f6:48:27   AutoConfig
-----

```

AutoConfig under the IfName column indicates that the IP management interface was created using VLAN 7.

To verify these auto-provisioning settings and verify that the EtherXtend 3400 was configured as a DHCP client with a VLAN 7 on the EFM bond group IP interface, enter **get ip-interface-record interface**:

```

zSH> get ip-interface-record 1/1/99/0/ip
ip-interface-record 1/1/99/0/ip
vpi: -----> {0}
vci: -----> {0}
rdindex: -----> {1}
dhcp: -----> {client}
addr: -----> {0.0.0.0}
netmask: -----> {0.0.0.0}
bcastaddr: -----> {255.255.255.255}
destaddr: -----> {0.0.0.0}
farendaddr: -----> {0.0.0.0}
mru: -----> {1500}
reasmmmaxsize: -----> {0}
ingressfiltername: -----> {}

```

## Basic Configuration

```
egressfiltername: -----> {}
pointtopoint: -----> {no}
mcastenabled: -----> {yes}
ipfwdenabled: -----> {yes}
mcastfwdenabled: -----> {yes}
natenabled: -----> {no}
bcastenabled: -----> {yes}
ingressPacketRuleGroupIndex: -> {0}
egressPacketRuleGroupIndex: --> {0}
ipaddrdynamic: -----> {dhcpclient}
dhcpserverenable: -----> {false}
subnetgroup: -----> {0}
unnumberedindex: -----> {0}
mcastcontrollist: -----> {}
vlanid: -----> {7}
maxVideoStreams: -----> {0}
tosOption: -----> {disable}
tosCOS: -----> {0}
vlanCOS: -----> {0}
s-tagTPID: -----> {0x8100}
s-tagId: -----> {0}
s-tagIdCOS: -----> {0}
```

## Customize the EtherXtend 3400 default settings

When installing EtherXtend 3400 software for the first time with auto-provisioning, auto-provisioning creates default bridges and configures the IP interface. (For a description of EtherXtend 3400 auto-provisioning, see [EtherXtend 3400 auto-provisioning on page 51](#)).



**Note:** When upgrading an EtherXtend 3400 from versions of the software without auto-provisioning to a version of the software with auto-provisioning, auto-provisioning will overwrite existing bridges and the IP interface with default settings.

After running auto-provisioning and changing the configuration of the EtherXtend 3400, you can save that configuration to a *default* file to restore your configuration later when needed. This *default* file will override factory default settings created by auto-provisioning. The system will use this file after a **set2default** command when there is no configuration currently on the system. You can also use this *default* file created on one system as a common base configuration for other systems by uploading the file to a server and downloading the *default* file to the other systems.

### Using customized EtherXtend 3400 default settings

Follow these steps to create a new *default* file that the EtherXtend 3400 recognizes every time the device is set to defaults. You can also use the *default* file to configure multiple EtherXtend 3400s.

- 1 Configure the EtherXtend 3400 with your unique settings for bridging, hosts, VLANs, IP addresses, etc. as needed.
- 2 Verify that you are in the *card1* directory before creating the *default* file:

```
zSH> cd /card1
zSH> pwd
/card1
```

- 3 Create the *default* file that stores your configuration and place that file in the *onreboot* directory with **dump file directory/filename**:

```
zSH> dump file /onreboot/default
```

- 4 Place the *default* file on multiple EtherXtend 3400s, if needed, by uploading the *default* file to a TFTP server, then downloading that *default* file from the TFTP server onto each EtherXtend 3400:

- a Upload the *default* file with **file upload [TFTP server ipAddr] [source filename] [destination filename]**:

```
zSH> file upload 172.16.100.123 /onreboot/default /
default
```

The source filename can include the directory path to the file.

- b** Download the *default* file into the onreboot directory of the EtherXtend 3400 with **file download** [*TFTP server ipAddr*] [*source filename*] [*destination filename*]:



**Note:** The EtherXtend 3400 will not recognize the destination file as the default configuration file unless the file is named *default*.

---

```
zSH> file download 172.16.100.123 /default /
onreboot/default
```

The destination directory and filename is always */onreboot/default*.

- 5** Reboot the EtherXtend 3400 and let it completely finish the reboot process.



**Note:** The EtherXtend 3400 does not use auto-provisioning or Zhone's factory defaults whenever you place a file named *default* in the *onreboot* directory.

---

```
zSH> reboot
Rebooting...
```

- 6** Set your defaults after the EtherXtend 3400 is completely booted and respond to several prompts after you log in using the login: *admin*, and password: *zhone* by entering **set2default**:

```
login: admin
password:
NOV 27 20:01:42: alert : 1/1/1027: clitask0:
CliUserConnect(): l=1695: tCliInit0: User admin logged
in on slot 1
zSH> set2default
No restore file (/card1/onreboot/restore) found.
Setting to default will result in an empty database.
Continue? (yes or no) [no]: yes
Ok to reset to default (system will reboot) ? [yes] or
[no]: yes
Do you want to exit from this request? (yes or no)
[yes] no
Are you sure? (yes or no) [no] yes
```

- 7** At this point the EtherXtend 3400 should be rebooting. To verify that the *default* file is loaded, notice that the EtherXtend 3400 will actually reboot twice. The first time it loads the default file, the second time it boots with the new configuration.

During the first boot, the load of the default will list various configurations being loaded. This is an example of what the configurations may look like:

```
restore partial file /card1/onreboot/default
if-translate (28)
```



```

if-next-index (1)
ether (4)
alarm-config (1)
bridge-interface-record (4)
dhcp-client-lease-resource (3)
dhcp-client-resource (1)
dhcp-server-options (1)
dsl-alarm (4)
dsl-config (4)
efm-port (4)
ether-oam (1)
info-reconcile (9)
ip-interface-record (2)
ipsla-cos-act (8)
ipsla-cos-map (64)
ipsla-global (1)
ntp-client-config (1)
pat-bind (1)
pme-profile (4)
rip-global-config (1)
rip-if-config (2)
system (1)
user-profile (2)
if-stack (22)
static-route (1)
card-profile (1)
(restore completed)

```

The first and last lines of this example should always be displayed on a successful load of the *default* file. All the other lines depend on what is in the *default* file and may or may not be present.

Shortly, after the (restore completed) line, the second reboot is started.

## Deleting your customized configuration and returning to factory defaults

If you need to delete your customized configuration and return to EtherXtend 3400 factory defaults:

- 1 Remove your custom configuration by removing the *default* file:

```
zSH> del /onreboot/default
```

- 2 Reset the EtherXtend 3400 to factory settings and run auto-provisioning:

```
zSH> set2default
```

Entering **set2default** erases the configuration in the EtherXtend 3400's database and restores factory default settings.

## System settings

This section describes the following system settings:

- [System security](#)
- [Radius support](#)
- [System logging](#)

### System security

There are several methods to guard against unauthorized access to your EtherXtend 3400, such as changing the default user password. You can also set up SNMP access lists to restrict access to your system. See [Creating community access lists](#) on page 86 for more information about setting SNMP access lists.

#### System login

Follow this example to login to a system. The default user name is *admin*, the default password is *zhone*.

```
login: admin
password:
zSH>
```

To log out of the system, enter the **logout** command:

```
zSh> logout
```



---

**Tip:** The system automatically logs you out after a period of inactivity. The default logout time is 10 minutes, but can be changed with the **timeout** command. Refer to the *Zhone CLI Reference Guide* for information on the **timeout** command.

---

### Changing the default user password

When adding users, the system automatically assigns a temporary password to each user. Most users will want to change this default password. Entering **changepass** changes the password for the current logged in user. The following is an example of changing a password:

```
jsmith> changepass
Current Password: enter current password
New Password : enter new password
Confirm New Password : confirm new password
User record updated.
Password change successful.
```



**Note:** Passwords are case sensitive.

## Radius support

The EtherXtend 3400 supports local and RADIUS (Remote Authentication Dial In User Service) access authentication. The EtherXtend 3400 can be configured for local authentication, RADIUS authentication, or RADIUS then local authentication. RADIUS users are configured with the Service-Type attribute as Administrative-User or NAS-Prompt-User. RADIUS is used for only login authentication, not severity levels.

[Table 14](#) shows the mapping of service-type to EtherXtend 3400 permissions.

**Table 14: Service type mapping to EtherXtend 3400 permissions**

Service-Type Attribute	EtherXtend 3400 permissions
Administrative-User	admin, zhonedebg, voice, data, manuf, database, systems, tools, useradmin
NAS-Prompt-User	admin, voice, data, manuf, database, systems, tools, useradmin

When establishing a connection to the EtherXtend 3400 with RADIUS authentication, the EtherXtend 3400 passes RADIUS information securely to the RADIUS server. The RADIUS server then authenticates the user and either allows or denies access to the EtherXtend 3400. If access is denied and the local authentication option is also configured, the EtherXtend 3400 then authenticates access based on the locally configured users and passwords. For logins and failed logins, a console message is generated with user ID and IP address of the device from which the login originated. Failed logins also are logged as alert level messages in the EtherXtend 3400 system log file.

By default, RADIUS access uses the UDP port 1812 for authentication. This parameter can be changed in the **radius-client** profile.

Figure 12: EtherXtend 3400 RADIUS authentication

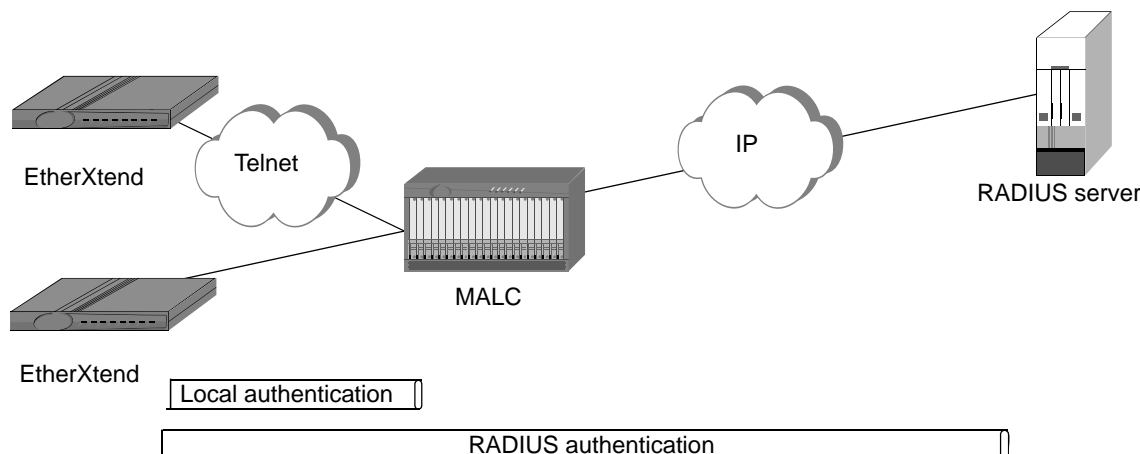

 **Note:** Follow the RADIUS server guidelines for RADIUS configuration instructions. For example, when using the EtherXtend 3400 with the FreeRadius server:

- Create only one entry in the clients.conf file for each subnet or individual EtherXtend 3400. For individual EtherXtend 3400s, the IP in this file must match the IP address of the outbound interface used by the EtherXtend 3400 to connect to the RADIUS server.
- The EtherXtend 3400 uses the value stored in the RADIUS system.sysname file for the NAS-Identifier attribute.
- The shared-secret in the EtherXtend 3400 **radius-client** profile, must exactly match the shared-secret in the RADIUS client entry.

### Configuring RADIUS support

The EtherXtend 3400 can be configured for local authentication, RADIUS authentication, or RADIUS then local authentication. Multiple **radius-client** profiles can be defined using the index and subindex numbers. This index scheme can be used to create index numbers for groups of RADIUS servers. When an index number is specified in the **system** profile, the EtherXtend 3400 attempts authentication from each RADIUS server in that group in sequential order of the subindex numbers.

To configure RADIUS support:

 **Note:** Before beginning this procedure, ensure that the EtherXtend 3400 has IP connectivity to the RADIUS server.

- 1 Update the RADIUS server with settings for the Zhone prompts.

- 2 Create a **radius-client** profile on the EtherXtend 3400 with the desired index number and RADIUS settings for server name, shared secret, number of retries, and other parameters. The first number in the index is used to group **radius-client** profiles so multiple profiles can be assigned to a EtherXtend 3400. The second number in the index specifies the order in which **radius-client** profiles are referenced.

This example specifies the radius-client *1/1* with server name *radius1* and a shared-secret of *secret*. The IP address is leased from a DHCP server so a DNS resolver must be configured in the system to resolve the server name and IP address. If a DNS resolver is not available, specify the IP address of the server. The index *1/1* specifies that this profile is the first profile in group 1.

```
zSH> new radius-client 1/1
Please provide the following: [q]uit.
server-name: ----> {}: radius1.test.com [DNS resolver must be configured in the system.]
udp-port: -----> {1812}:
shared-secret: --> {** password **}: secret
retry-count: ----> {5}:
retry-interval: -> {1}:
.....
Save new record? [s]ave, [c]hange or [q]uit: s
Record created.
```

Another method to reference the RADIUS server is by specifying the IP address. This example specifies the radius-client *1/1* with server IP address 172.24.36.148 and a shared-secret of *secret*. The index *1/1* specifies that this profile is the first profile in group 1.

```
zSH> new radius-client 1/1
Please provide the following: [q]uit.
server-name: ----> {}: 172.24.36.248
udp-port: -----> {1812}:
shared-secret: --> {** password **}: secret
retry-count: ----> {5}:
retry-interval: -> {1}:
.....
Save new record? [s]ave, [c]hange or [q]uit: s
Record created.
```

- 3 Create additional **radius-client** profiles for each additional RADIUS server to be assigned to this EtherXtend 3400. The index number is incremented (for example *1/2* for the second RADIUS server in group 1) to specify the sequence in the profile group.

```
zSH> new radius-client 1/2
Please provide the following: [q]uit.
server-name: ----> {}: 172.24.36.249
udp-port: -----> {1812}:
shared-secret: --> {** password **}: secret
retry-count: ----> {5}:
retry-interval: -> {1}:
```

```

.....
Save new record? [s]ave, [c]hange or [q]uit: s
Record created.

```

- 4 In the **system** profile on the EtherXtend 3400, set the desired user authentication method and specify the index of the **radius** profile to use. This examples specifies the **radiusauthindex** of *1*. This index is configured with two **radius-client** profiles (*1/1*, *1/2*). The EtherXtend 3400 first attempts authentication using the server specified in radius-client *1/1*. If this authentication fails, the EtherXtend 3400 attempts authentication using radius-client *1/2* server. If this authentication also fails, the EtherXtend 3400 then attempts authentication based on the authentication mode setting in the **system** profile. This example uses **radiusthenlocal**.



**Caution:** If the *radius* authentication mode is used, local authentication is disabled so the EtherXtend 3400 may become inaccessible if IP connectivity to the RADIUS server is lost or other changes prevent the EtherXtend 3400 from receiving RADIUS authentication.

```

zSH> update system 0
Please provide the following: [q]uit.
syscontact: -----> {Zhone Global Services and Support 7001 Oakport
Street          Oakland Ca. (877) Zhone20 (946-6320) Fax (510)777-7113
support@zhone.com}:
sysname: -----> {EtherXtend1}:
syslocation: -----> {Oakland}:
enableauthtraps: -----> {disabled}:
setserialno: -----> {0}:
zmsexists: -----> {true}:
zmsconnectionstatus: --> {inactive}:
zmsipaddress: -----> {172.16.49.76}:
configsyncexists: -----> {false}:
configsyncoverflow: ---> {false}:
configsyncpriority: ---> {high}:
configsyncaction: -----> {noaction}:
configsyncfilename: ---> {172.16.88.14_4_1178142210378}:
configsyncstatus: -----> {synccomplete}:
configsyncuser: -----> {zmsftp}:
configsyncpasswd: -----> {** private **}: ** read-only **
numshelves: -----> {1}:
shelvesarray: -----> {}:
numcards: -----> {3}:
ipaddress: -----> {172.16.88.14}:
alternateipaddress: ---> {0.0.0.0}:
countryregion: -----> {us}:
primaryclocksource: ---> {0/0/0/0/0}:
ringsource: -----> {internalringsourcelabel}:
revertiveclocksource: -> {true}:
voicebandwidthcheck: --> {false}:
alarm-levels-enabled: -> {critical+major+minor+warning}:

```

```

userauthmode: -----> {local}: radiusthenlocal
radiusauthindex: -----> {0}: 1
.....
Save changes? [s]ave, [c]hange or [q]uit: s
Record updated.
zSH>

```

After completing the RADIUS configuration, the EtherXtend 3400 displays console messages for RADIUS login and logout activity.

For users logging in through RADIUS, the system prompt appears as the *username@systemname*. For example, the system prompt for a basic user on a EtherXtend 3400 using the default Zhone EtherXtend 3400 system name will appear as *basicuser@Zhone EtherXtend*. The system name is configured using the **sysname** parameter in the **System 0** profile.

## System logging

System logs can be enabled to record session activity and user access.

### Enabling and disabling logging

By default logging is enabled on the serial craft port and disabled over telnet sessions. To enable or disable logging for the session, enter:

```
zSh> log session on/off
```

The **log session** command only applies to the current session. You can also enable or disable logging for all serial craft port sessions enter:

```
zSh> log serial on/off
```

This command setting persists across system reboots.

## Device interface

Although the EtherXtend 3400 does not have cards, the EtherXtend 3400 device settings are stored in the **card-profile** parameter. Update the **card-profile** to modify the device settings. The device type number for the EtherXtend 3400 is 7108.

```
zSH> get card-profile 1/1/7108
```

```

card-profile 1/1/7101
sw-file-name: -----> {ethx3400.bin}
admin-status: -----> {operational}
upgrade-sw-file-name: ----> {}
upgrade-vers: -----> {}
admin-status-enable: ----> {enable}
sw-upgrade-admin: -----> {reloadcurrrev}
sw-enable: -----> {true}
sw-upgrade-enable: -----> {false}
card-group-id: -----> {1}

```

```

hold-active: -----> {false}
weight: -----> {nopreference}
card-line-type: -----> {unknowntype}
card-atm-configuration: -> {notapplicable}
card-line-voltage: -----> {not-used}
maxvpi-maxvci: -----> {notapplicable}
card-init-string: -----> {}
wetting-current: -----> {disabled}

```

## LAN interfaces to CPEs

The EtherXtend 3400 provides 4 Ethernet LAN ports for 10/100 Ethernet connections to CPEs or subtended devices.

Use the following command to display the available Ethernet LAN interfaces.

```

zSH> list ether
ether 1-1-1-0/eth
ether 1-1-2-0/eth
ether 1-1-3-0/eth
ether 1-1-4-0/eth
4 entries found.

```

A profile is available for each Ethernet LAN interface to configure Ethernet parameters. Use the following command to configure the Ethernet LAN port settings. This example changes the pauseFlowControl setting to symmetric.

```
zSH> update ether 1-1-1-0/eth
```

```

ether 1-1-1-0/eth
Please provide the following: [q]uit.
autonegstatus: -----> {enabled}
mauType: -----> {mau100basetxfd}
restart: -----> {norestart}
ifType: -----> {mau100basetxfd}
autonegcap: -----> {b10baseT+b10baseTFD+b100baseTX+b100baseTXFD}
remotefault: -----> {noerror}
clksrc: -----> {automatic}
pauseFlowControl: -> {disabled} symmetric
.....
Save changes? [s]ave, [c]hange or [q]uit: s
Record updated.

```

## Moving PC cables on Ethernet ports

If a PC cable is moved from one Ethernet port to another on the EtherXtend 3400, a **bridge flush** command may be given from the EtherXtend 3400 CLI to force re-learning the PC's MAC address on the new Ethernet port. If the **bridge flush** command is not given, the MAC address timeout is 3600 seconds.



## Configure an IP interface on an Ethernet port

To configure an IP interface, you must create an **ip-interface-record** profile on the LAN/WAN interface with the **interface add** command.

The **ip-interface-record** profile specifies the basic IP parameters of the LAN/WAN interface. These include the IP address and netmask, and the services enabled on the interface as shown in [Table 15](#). Each **ip-interface-record** profile is associated with a specific physical interface.



**Tip:** If you use the address format (with slashes instead of dashes) when creating the IP interface, the system will recognize the physical address and automatically bind the Ethernet line group to the new IP interface over the Ethernet port.

**Table 15: Interface parameters**

Parameter	Description
<b>addr</b>	The IP address of the EtherXtend 3400 device in dotted-decimal format.
<b>netmask</b>	The subnet mask associated with the IP interface. The value of the mask is an IP address with all the network bits set to 1 and all the hosts bits set to 0.
<b>bcastaddr</b>	The IP broadcast address used for sending datagrams on the (logical) interface associated with the IP interface. The broadcast address is determined by the IP address and the netmask. It should always be set to an IP address that is the network address of the interface with all ones in the host portion of the address.
<b>mru</b>	The size, in octets, of the largest packet that can be received on the IP interface. For interfaces used for network datagrams, this is the size of the largest network datagram that can be received on the interface.

To create an IP interface, you need to know the logical address of the physical interface over which IP will run. The syntax for the interface add command is:

```
interface add <ifIndex>/<type> [vlan <vlan_id>] <ip_address> <netmask>
```

To create the IP interface, enter **interface add** *interface/type ip\_address netmasks*:

```
zSH> interface add 1-1-4-0/eth 192.168.88.200 255.255.255.0
Created ip-interface-record 1-1-4-0-eth/ip
```

Use the **new ip-interface-record** command when more advanced settings are required. This command accesses all the settings in the **ip-interface-record** profile and should be configured by advanced users.

```
zSH> new ip-interface-record 1/1/4/0/ip
Please provide the following: [q]uit.
vpi: -----> {0}:
vci: -----> {0}:
rdindex: -----> {1}:
dhcp: -----> {none}: ** read-only **
addr: -----> {0.0.0.0}: 192.168.88.200
netmask: -----> {0.0.0.0}: 255.255.255.0
bcastaddr: -----> {0.0.0.0}: 192.168.88.255
destaddr: -----> {0.0.0.0}:
farendaddr: -----> {0.0.0.0}:
mru: -----> {1500}:
reasmmaxsize: -----> {0}:
ingressfiltername: -> {}:
egressfiltername: --> {}:
pointtopoint: -----> {no}:
mcastenabled: -----> {yes}:
ipfwdenabled: -----> {yes}:
mcastfwdenabled: ----> {yes}:
natenabled: -----> {no}:
bcastenabled: -----> {yes}:
ingressfilterid: ----> {0}:
egressfilterid: ----> {0}:
ipaddrdynamic: -----> {static}:
dhcpserverenable: --> {false}:
subnetgroup: -----> {0}
unnumberedindex: ----> {0}
mcastcontrollist: --> {}:
vlanid: -----> {0}:
maxVideoStreams: ----> {0}:
tosOption: -----> {disable}:
tosCOS: -----> {0}:
vlanCOS: -----> {0}:
s-tagTPID: -----> {0x8100}:
s-tagId: -----> {0}:
s-tagIdCOS: -----> {0}:
.....
Save new record? [s]ave, [c]hange or [q]uit: s
```

This IP Interface has been automatically bound to  
1-1-4-0-eth  
New record saved.

To verify that the Ethernet interface has been set up, enter **interface show**:

```
zSH> interface show
```

```
1 interface
```

Interface	Status	Rd/Address	Media/Dest Address	IfName
1/1/4/0/ip	UP	1 172.24.200.133/24	00:01:47:f6:48:1c	1-1-4-0-eth

## IP on a bridge

IP on a bridge allows you to put an IP address on a bridged VLAN. This allows VLANs to be used to manage multiple EtherXtend 3400s or other devices. One IP on a bridge can be created on a EtherXtend 3400. The following example provides a typical example of how you would configure IP on a bridge.

### Creating the IP on a bridge interface

Create an IP on a bridge interface using the IP address of 10.11.12.13/24, and a logical port interface 6 with a VLAN 200



**Note:** The logical port interface for IP on a bridge *must* be *1-1-6-0/ipobridge* for correct transmission of IP packets.

- 1 Enter **interface add** *interface/type* with the type as *ipobridge*:

```
zSH> interface add 1-1-6-0/ipobridge vlan 200 10.11.12.13/24
Created ip-interface-record ipobridge-200/ip.
```

This command creates the new IP interface as well as a new bridge. The bridge created will be a Transparent LAN Service (TLS) bridge.

- 2 Enter **interface show** to verify the IP interface:

```
zSH> interface show
2 interfaces
Interface      Status  Rd/Address          Media/Dest Address  IfName
-----
1/1/6/0/ip     UP      1 10.11.12.13/24   00:01:47:f6:48:25   ipobridge-200
1/1/99/0/ip    UP      1 0.0.0.0/0        00:01:47:f6:48:27   AutoConfig
-----
```

Enter **bridge show** to verify the ipobridge:

```
zSH> bridge show
Type VLAN      Bridge                                     St  Table Data
-----
tls          7 1-1-99-0-efmbond/bridge                 UP
tls Tagged   1-1-99-0-efmbond-0/bridge                 UP
tls          7 1-1-1-0-eth/bridge                       DWN
tls Tagged   1-1-1-0-eth-0/bridge                     DWN
tls          7 1-1-4-0-eth/bridge                       DWN
tls Tagged   1-1-4-0-eth-0/bridge                     DWN
tls          7 1-1-3-0-eth/bridge                       DWN
tls Tagged   1-1-3-0-eth-0/bridge                     DWN
tls          7 1-1-2-0-eth/bridge                       DWN
tls Tagged   1-1-2-0-eth-0/bridge                     DWN
tls Tagged 200 ipobridge-200/bridge                     UP
```

- 3 Create another bridge on an uplink port to manage traffic going to the uplink connection with **bridge add**:

```
zSH> bridge add 1-1-99-0/efmbond tls vlan 200 tagged
Adding bridge on 1-1-99-0/efmbond
Created bridge-interface-record 1-1-99-0-efmbond-200/bridge
```

The uplink connection is now reachable from the upstream, and IP 10.11.12.13/24 can reach other upstream devices on the same VLAN.

- 4 Enter **bridge show** to verify the IP on a bridge and the upstream connection bridge on VLAN 200:

```
zSH> bridge show
Type VLAN      Bridge                               St  Table Data
-----
tls            7 1-1-99-0-efmbond/bridge            UP
tls Tagged    1-1-99-0-efmbond-0/bridge          UP
tls           7 1-1-1-0-eth/bridge                 DWN
tls Tagged    1-1-1-0-eth-0/bridge              DWN
tls           7 1-1-4-0-eth/bridge                 DWN
tls Tagged    1-1-4-0-eth-0/bridge              DWN
tls           7 1-1-3-0-eth/bridge                 DWN
tls Tagged    1-1-3-0-eth-0/bridge              DWN
tls           7 1-1-2-0-eth/bridge                 DWN
tls Tagged    1-1-2-0-eth-0/bridge              DWN
tls Tagged 200 ipobridge-200/bridge              UP
tls Tagged 200 1-1-99-0-efmbond-200/bridge      UP
```

Follow the same steps to create an IP on a bridge and bridges for downstream devices.

The IP on a bridge feature does not support SNMP.

## Deleting IP on a bridge and the upstream connection bridge

- 1 Delete the IP on a bridge interface when necessary by entering **interface delete interface/type vlan vlan ID**:

```
zSH> interface delete 1/1/6/0/ipobridge vlan 200
Delete complete
```

Enter **interface show** to verify the ipobridge interface is deleted.

```
zSH> interface show
1 interface
Interface      Status  Rd/Address          Media/Dest Address  IfName
-----
1/1/99/0/ip    UP      1 0.0.0.0/0        00:01:47:f6:48:27   AutoConfig
```

- 2 Delete the IP on a bridge and the upstream bridge connection when necessary by entering **bridge delete ipobridge-vlan id/bridge vlan vlan id**:

```
zSH> bridge delete ipobridge-200/bridge vlan 200
ipobridge-200/bridge Delete complete
zSH> bridge delete 1-1-99-0/efmbond vlan 200
```

1-1-99-0/efmbond Delete complete

**3** Verify that the bridges are deleted with **bridge show**:

```
zSH> bridge show
Type VLAN      Bridge                               St  Table Data
-----
tls          7 1-1-99-0-efmbond/bridge            UP
tls Tagged   1-1-99-0-efmbond-0/bridge          UP
tls          7 1-1-1-0-eth/bridge                 DWN
tls Tagged   1-1-1-0-eth-0/bridge               DWN
tls          7 1-1-4-0-eth/bridge                 DWN
tls Tagged   1-1-4-0-eth-0/bridge               DWN
tls          7 1-1-3-0-eth/bridge                 DWN
tls Tagged   1-1-3-0-eth-0/bridge               DWN
tls          7 1-1-2-0-eth/bridge                 DWN
tls Tagged   1-1-2-0-eth-0/bridge               DWN
```

# 7

## ETHERXTEND 3400 SHDSL WAN INTERFACES

This chapter describes the WAN SHDSL interfaces on the EtherXtend 3400:

- [WAN SHDSL interfaces, page 71](#)
- [EtherXtend 3400 EFM 802.3ah bonding, page 79](#)
- [Bond group/physical line stats, page 81](#)

### WAN SHDSL interfaces

The EtherXtend 3400 device can have either 4 or 8 SHDSL WAN interfaces for use as individual interfaces or as members of a bond group. The EtherXtend 3400 supports 2-wire SHDSL cards. The EtherXtend 3400 uses the shelf-slot-port-subport/type syntax to identify system interfaces.

The EtherXtend 3400 always follows the convention of shelf is *I*, slot is *I*, and subport is *O*. The *type* is based on the Internet Assigned Numbers Authority interface type (IANAiftype) definitions.

This section describes how to set the following profiles for SHDSL interface configuration:

- [Set pme-profile settings on page 71](#)
- [Set dsl-config profile settings on page 74](#)
- [Configure efm-port settings on page 77](#)

### Set pme-profile settings

A *pme-profile* (Physical Medium Entities) is available for each SHDSL WAN port. PME profiles are used to set link rates. To display PME profiles, enter **list pme-profile**:

```
zSH> list pme-profile
pme-profile 1-1-1-0/shdsl
pme-profile 1-1-2-0/shdsl
pme-profile 1-1-3-0/shdsl
pme-profile 1-1-4-0/shdsl
pme-profile 1-1-5-0/shdsl
pme-profile 1-1-6-0/shdsl
pme-profile 1-1-7-0/shdsl
pme-profile 1-1-8-0/shdsl
```

8 entries found.

To display the PME parameters in their default state, enter **get pme-profile interface/type**:

```
zSH> get pme-profile 1-1-1-0/shdsl
pme-profile 1-1-1-0/shdsl
efmCuPmeAdminSubType: -----> {ieee2baset1r}
efmCuPmeAdminProfile: -----> {0}
efmCuPAFRemoteDiscoveryCode: -----> {}
efmCuPmeThreshLineAtn: -----> {0}
efmCuPmeThreshSnrMgn: -----> {0}
efmCuPmeLineAtnCrossingEnable: --> {false}
efmCuPmeSnrMgnCrossingEnable: ---> {false}
efmCuPmeDeviceFaultEnable: -----> {false}
efmCuPmeConfigInitFailEnable: ---> {false}
efmCuPmeProtocolInitFailEnable: -> {false}
efmCuPme2BProfileDescr: -----> {}
efmCuPme2BRegion: -----> {region1}
efmCuPme2BDataRate: -----> {0}
efmCuPme2BPower: -----> {0}
efmCuPme2BConstellation: -----> {adaptive}
efmCuPme2BProfileRowStatus: -----> {active}
efmCuPmeNtr: -----> {ntr-local-osc}
```

## Set a region

For the **efmCuPme2BRegion** parameter, the regions are set as specified in the relevant Regional Annex of [G.9991.2]. Regional settings place limitation on the max allowed data rate, power, and constellation. The possible values for this parameter are:

- region 1  
Annex A and F (North America)
- region 2  
Annex B and G (Europe)

You can only change regions when the link is down.

## Set auto-negotiate or a data rate

For the **efmCuPme2BDataRate** parameter, setting the parameter to 0 sets the data rate to auto-negotiate. Entering a range between 192 and 5696 defines a specific range of the data rate.

[Table 16](#) provides the settings for the **efmCuPme2BConstellation** parameter.



**Table 16: efmCuPme2BConstellation parameter**

Constellation settings	Rate range
TCPAM16	192 to 3840
TCPAM32	768 to 5696
Adaptive	192 to 5696

To modify **pme-profile** values, enter **update pme-profile** *interface/type*:

```
zSH> update pme-profile 1-1-3-0/shdsl
pme-profile 1-1-3-0/shdsl
Please provide the following: [q]uit.
efmCuPmeAdminSubType: -----> {ieee2baset1r}:
efmCuPmeAdminProfile: -----> {0}:
efmCuPAFRemoteDiscoveryCode: ----> {}:
efmCuPmeThreshLineAtn: -----> {0}:
efmCuPmeThreshSnrMgn: -----> {0}:
efmCuPmeLineAtnCrossingEnable: --> {false}:
efmCuPmeSnrMgnCrossingEnable: ----> {false}:
efmCuPmeDeviceFaultEnable: -----> {false}:
efmCuPmeConfigInitFailEnable: ---> {false}:
efmCuPmeProtocolInitFailEnable: -> {false}:
efmCuPme2BProfileDescr: -----> {}:
efmCuPme2BRegion: -----> {region1}:
efmCuPme2BDataRate: -----> {0}:
efmCuPme2BPower: -----> {0}:
efmCuPme2BConstellation: -----> {adaptive}:
efmCuPme2BProfileRowStatus: ----> {active}:
efmCuPmeNtr: -----> {ntr-local-osc}:
.....
Save changes? [s]ave, [c]hange or [q]uit:
```

## Set automatic baud rate adaption and fixed rate settings

When you select the **shdsl-2btl** line type for an SHDSL interface, the EtherXtend 3400 can perform automatic baud rate adaption. This allows receiving devices to communicate with transmitting devices operating at different baud rates without the need to establish data rates in advance. By determining the baud rate from the transmitting device, the receiving EtherXtend 3400 automatically trains to match the line rate of the incoming data.

The automatic baud rate adaption process may take several minutes. This is because the CO and CPE device modems use an algorithm to step through a sequence of baud rates, where the devices establish a connection at each line rate and then move to the next higher rate until they reach the final rate they agree upon.

Table 17 shows the adaptive [fixed-rate=0] and fixed line rate settings defined in the **efmCuPme2BDataRate** entry of the **pme-profile**.

**Table 17: Fix-bit-rate settings and modem train rates**

CO	CPE	Then
efmCuPme2BDataRate = 0 efmCuPme2BDataRate = 0	efmCuPme2BDataRate = 0 efmCuPme2BDataRate = non-zero value = x	Highest available rate is negotiated. x is treated as the MAXIMUM train rate allowed. Modems train at x or less.
efmCuPme2BDataRate = non-zero value = x	efmCuPme2BDataRate = 0	x is treated as the MAXIMUM train rate allowed. Modems train at x or less.
efmCuPme2BDataRate = non-zero value = x	efmCuPme2BDataRate = non-zero-value = x	x is treated as the MAXIMUM train rate allowed. Modems train at x or less.
efmCuPme2BDataRate = non-zero value = x	efmCuPme2BDataRate = non-zero-value = y	The lesser of x and y = z will be treated as the MAXIMUM train rate allowed. Modems train at x or less.

## Set dsl-config profile settings

The **dsl-config** profile provides settings for DSL options, such as co/cpe mode, line-type, unit-mode, and others. Table 18 summarizes the commands required to configure SDSL interfaces on the EtherXtend 3400:

**Table 18: SDSL configuration commands**

Action	Command
Verify the type of SHDSL interface.	<b>update dsl-config index/shdsl</b> Where index is of the form shelf-slot-port-subport or a user-defined string.
Verify the interface is active.	<b>showlinestatus shelf slot port</b>

## Specify dsl-config settings

The **line-type** parameter is set at **shdsl-2tbl**. Table 19 describes configurable settings for the **dsl-config** profile parameters:

**Table 19: dsl-config profile**

Parameter	Description
<b>unit-mode</b>	Specifies whether the unit is configured as a CO or CPE device. Values: <b>co</b> <b>cpe</b> Default: <b>cpe</b>
<b>line-status-trap</b>	Specifies whether a line status trap should be sent whenever the DSL line goes up or down. Note that this setting does not apply to line status traps sent during system bootup. During bootup, line status traps are not sent. A DSL link down trap has a moderate severity level and a link up trap has a low severity. Values: <b>enable</b> <b>disabled</b> Default: <b>disabled</b>

To specify a setting in the **dsl-config** profile such as **line-type**, enter **update dsl-config interface/type**:

```
zSH> update dsl-config 1-1-1-0/shdsl
dsl-config 1-1-1-0/shdsl
Please provide the following: [q]uit.
line-type: -----> {shdsl-2bt1}: shdsl-2bt1
unit-mode: -----> {cpe}:
line-status-trap-enable: -> {disabled}:
admin-up-line-alarm: -----> {disabled}:
.....
Save changes? [s]ave, [c]hange or [q]uit: s
Record updated.
```

To view the change, enter **get dsl-config 1-1-4-0/shdsl**:

```
zSH> get dsl-config 1-1-4-0/shdsl
dsl-config 1-1-4-0/shdsl
line-type: -----> {shdsl-2bt1}
unit-mode: -----> {cpe}
line-status-trap-enable: -> {disabled}
admin-up-line-alarm: -----> {disabled}
```

## Verify the interface

Entering **showlinestatus** displays the status of the interfaces in the system. The following example displays some of the information returned by this command.

```

zSH> showlinestatus
----- N2NBOND RP -----
.....
Type -----> N2NBOND (22)
Registered lines ---> 1
.....
Line Type-----> N2NBOND (22)
GroupId -----> 22
Redundancy -----> NONE (0)
TxClk -----> NONE (1)
RefClkSrc -----> NO
If_index -----> 21
Shelf -----> 1
Slot -----> 1
Port -----> 201
SubPort -----> 0
----- EFMBOND RP -----
.....
Type -----> EFMBOND (23)
Registered lines ---> 0
----- SHDSL RP -----
.....
Type -----> SHDSL (18)
Registered lines ---> 4
Line Type-----> SHDSL (18)
GroupId -----> 10
Status -----> ACTIVE (1)
Redundancy -----> NONE (0)
TxClk -----> NONE (1)
RefClkSrc -----> NO
If_index -----> 9
Shelf -----> 1
Slot -----> 1
Port -----> 1
SubPort -----> 0
Status -----> ACTIVE (1)

```

To display the status of the interface, enter **dslstat interface/type**:

```

zSH> dslstat 1-1-4-0/shdsl
General Stats:
-----
AdminStatus.....UP
DslUpLineRate (bitsPerSec).....0
DslDownLineRate (bitsPerSec).....0
DslMaxAttainableUpLineRate (bitsPerSec).....5696000
DslMaxAttainableDownLineRate (bitsPerSec)....5696000
Out Octets.....0

```

```

Out Pkts/Cells.....0
Out Discards.....0
Out Errors.....0
In Octets.....0
In Pkts/Cells.....0
In Discards.....0
In Errors.....0
DSL Physical Stats:
-----
DslLineSnrMgn (tenths dB).....0
DslLineAtn (tenths dB).....0
DslCurrOutputPwr (tenths dB).....0
LOFS.....0
LOLS.....0
LOSS.....0
ESS.....352902
CRC Errors.....0
Inits.....0

```

## Configure efm-port settings

The **efm-port** profile provides settings for EFM port, such as admin state, snr mode, and others. To view EFM ports, enter **list efm-port**:

```

zSH> list efm-port
efm-port 1-1-1-0/shdsl
efm-port 1-1-2-0/shdsl
efm-port 1-1-3-0/shdsl
efm-port 1-1-4-0/shdsl
efm-port 1-1-5-0/shdsl
efm-port 1-1-6-0/shdsl
efm-port 1-1-7-0/shdsl
efm-port 1-1-8-0/shdsl
8 entries found.

```

To display the range or options of EFM port parameters, enter **show efm-port**. The following values are available on the **efm-port** interface.

```

zSH> show efm-port
efmCuPAFAdminState:-----> enabled disabled
efmCuPAFDiscoveryCode:-----> {260}
efmCuAdminProfile:-----> {8}
efmCuTargetDataRate:-----> {1 - 999999}
efmCuTargetWorstCaseSnrMgn:-----> {-10 - 21}
efmCuThreshLowBandwidth:-----> {0 - 100000}
efmCuLowBandwidthEnable:-----> true false
efmCuTargetCurrentConditionMode:----> true false
efmCuTargetCurrentConditionSnrMgn:-> {-10 - 21}
efmCuTargetWorstCaseMode:-----> true false

```

To change or update the **efm-port** parameter, enter the **update-efm-port interface/type**:

```

zSH> update efm-port 1-1-1-0/shdsl
efm-port 1-1-1-0/shdsl
Please provide the following: [q]uit.
efmCuPAFAdminState: -----> {enabled}:
efmCuPAFDiscoveryCode: -----> {}:
efmCuAdminProfile: -----> {0x01}:
efmCuTargetDataRate: -----> {50000}:
efmCuTargetWorstCaseSnrMgn: -----> {0}:
efmCuThreshLowBandwidth: -----> {0}:
efmCuLowBandwidthEnable: -----> {false}: true
efmCuTargetCurrentConditionMode: ---> {false}:
efmCuTargetCurrentConditionSnrMgn: -> {6}:
efmCuTargetWorstCaseMode: -----> {true}:
.....
Save changes? [s]ave, [c]hange or [q]uit: s
Record updated.

```

## Set EFM connect rate

When the rate selection algorithm is designed to use **efmCuTargetWorstCaseSnrMgn**, the modem will select a more conservative connect rate based on a minimum noise level that is artificially determined. When **efmCuTargetWorstCaseSnrMgn** is set to 0dB, the modem automatically selects the connect rate that would result in 0dB SNR margin if the crosstalk noise level was equal to the noise in a binder fully loaded with SHDSL links. The result is that on lightly loaded loops, the connect rate is lower than it could be and the SNR Margin is much higher than it needs to be for reliable operation. However, when the loop plant fills up with SHDSL connections, the originally selected rate will still be valid, and there will be no service interruptions caused by retraining of loops in the binder as the noise profile changes when more links are added.

If you would rather not use the **efmCuTargetWorstCaseSnrMgn** setting, set **efmCuTargetWorstCaseMode** to false and set **efmCuTargetCurrentConditionMode** to true. Zhone recommends that **efmCuTargetWorstCaseSnrMgn** be set to 0 and **efmCuTargetCurrentConditionSnrMgn** be set to 6.

**Note:** Previous releases of EtherXtend 3400 show the **efmCuTargetWorstCaseSnrMgn** to be 1. Enter the **set2default** command to view the current default setting of 0.

---

To view current parameter settings, enter **get efm-port interface/type**:

```

zSH> get efm-port 1-1-1-0/shdsl
efm-port 1-1-1-0/shdsl
efmCuPAFAdminState: -----> {enabled}
efmCuPAFDiscoveryCode: -----> {}
efmCuAdminProfile: -----> {0x01}
efmCuTargetDataRate: -----> {50000}
efmCuTargetWorstCaseSnrMgn: -----> {0}
efmCuThreshLowBandwidth: -----> {0}
efmCuLowBandwidthEnable: -----> {false}

```

```
efmCuTargetCurrentConditionMode: ---> {false}
efmCuTargetCurrentConditionSnrMgn: -> {6}
efmCuTargetWorstCaseMode: -----> {true}
```

## EtherXtend 3400 EFM 802.3ah bonding

EFM (Ethernet in the First Mile) extends Ethernet signaling between the EtherXtend-EFM-SHDSL-24 card and EtherXtend 3400 or other EFM-enabled CPEs.

By default, all ports are configured in N2N bond groups and can be re-configured for EFM bonding.

This section describes the following:

- [Create bond groups on page 79](#)
- [Display bond groups on page 80](#)
- [Change bond group type on page 80](#)
- [Delete bond groups on page 81](#)

### Create bond groups

The **bond add** and **list if-translate** commands are used to add and verify a single N2N or EFM bond group. If the bond group already exists, adding an identical group with a different bond type changes the bond group type.



**Note:** Bond groups created with CLI commands must be greater than 24 and less than 100. 100-series bond group IDs are used by ZMS and 200-series bond groups are auto-provisioned/discovered.

```
zSH> bond add group 1-1-40-0/n2nbond
```

```
zSH> bond add group 1-1-50-0/efmbond
```

To add a new member to an existing bond group and view the link, enter:

```
zSH> bond add member 1-1-40-0/n2nbond 1-1-1-0/shdsl
```

```
zSH> list if-stack
```

```
.....
if-stack 1-1-40-0/n2nbond/1-1-1-0-shdsl/n2nlink
```

To create a bond group with multiple members and view the bond groups:

```
zSH> bond add member 1-1-40-0/n2nbond 1-1-3-0/shdsl
```

```
1-1-4-0/shdsl
```

```
zSH> list if-translate
```

```
.....
if-translate 1-1-40-0/n2nbond
if-translate 1-1-40-0-n2nbond/linegroup
```

## Display bond groups

Bond groups can be displayed for all existing groups, a specific group, a specific slot, or link.

To display all configured bond groups:

```
zSH> bond show all
```

Bond Groups				
Slot	GrpId	Name	Type	State
1	40	1-1-40-0	n2nbond	OOS
1	102	1-1-102-0	efmbond	OOS
1	101	1-1-101-0	n2nbond	OOS

To display a specific bond group:

```
zSH> bond show group 1-1-40-0/n2nbond
```

Bond Groups				
Slot	GrpId	Name	Type	State
1	40	1-1-40-0	n2nbond	OOS
Group Members				
Slot	Port	Name	Type	State
1	3	1-1-3-0	shdsl	OOS
1	4	1-1-4-0	shdsl	OOS

To display bond groups by slot:

```
zSH> bond show slot 1
```

Bond Groups				
Slot	GrpId	Name	Type	State
1	40	1-1-40-0	n2nbond	OOS
1	102	1-1-102-0	efmbond	OOS
1	101	1-1-101-0	n2nbond	OOS

To display bond groups for a specific link: bond show link 1-1-40-0/shdsl

```
zSH> bond show link 1-1-40-0/shdsl
```

Bond Groups				
Slot	GrpId	Name	Type	State
1	40	1-1-40-0	n2nbond	OOS
Group Members				
Slot	Port	Name	Type	State
1	3	1-1-3-0	shdsl	OOS
1	4	1-1-4-0	shdsl	OOS

## Change bond group type

Bond group type can be changed for individual bond groups or all bond groups used in a specified slot using **bond move** and **bond modify**.

```
zSH> bond move 1-1-102-0/efmbond 1-1-101-0/n2nbond
1-1-2-0/shdsl
```



```
zSH> bond modify efm group 1-1-101-0/n2nbond
```

```
zSH> bond modify efm slot 1
```

## Delete bond groups

Bond groups can be deleted by individual member or entire group.

```
zSH> bond delete member 1-1-101-0/n2nbond 1-1-3-0/shds1
```

```
zSH> bond delete group 1-1-101-0/n2nbond
```

## Bond group/physical line stats

Data in the **dslstat** command is provided for bond groups. The data is collected differently for N2N and EFM ports and bond groups. This section describes:

- [Packet counts on page 81](#)
- [Bond group bandwidth on page 82](#)

## Packet counts

EFM bonding fragments packets across multiple lines so that packet counts for EFM ports indicate the number of EFM packet fragments for that port. At the physical port level, EFM unicast packet counts show the number of packet fragments for that port. Octets at the EFM physical port include all bytes received, including those from errored packet fragments and protocol overhead.

The packet count for N2N bond groups show the number of complete packets that traversed the bond group and indicate the number of unicast, multicast, and broadcast packets for that bond group. Octets at the N2N bond group include all bytes received from all valid packets; bytes from errored packets and protocol overhead are not included.

To display the aggregate statistics for a specified bond group interface or if-index, use **bond stats**.

Use **bond show** to view the type of bond group and the interface name for the bond group to gather statistics. The EtherXtend 3400 is always slot 1.

```
zSH> bond show slot 1
```

Bond Groups				
Slot	GrpId	Name	Type	State
1	201	1-1-201-0	efmbond	ACT

```
zSH> bond stats 1-1-201-0/efmbone
```

```
***** Bond group statistics *****
Group Info
```

```

Slot      GrpId      Interface Name      IfIndex
  1        201      1-1-201-0/efmbond      33

UP                UP                17152000      0.00:10:15
      Group Members
Port      Interface Name      IfIndex
  4        1-1-4-0/shdsl      15
  6        1-1-6-0/shdsl      19
  1        1-1-1-0/shdsl      5
  5        1-1-5-0/shdsl      17
  7        1-1-7-0/shdsl      21
  2        1-1-2-0/shdsl      8
  8        1-1-8-0/shdsl      23
  3        1-1-3-0/shdsl      12

      Statistics (Received)
Octets                2955877408
Ucast                42200684
Mcast                0
Bcast                28
Discards            0
Errors              0

      Statistics (Transmitted)
Octets                2118780630
Ucast                252843879
Mcast                252843808
Bcast                0
Discards            0
    
```

## Bond group bandwidth

Table 20 shows the bond group bandwidth rates for EFM 4-port bond groups.

**Table 20: Bond group bandwidth**

Frame Size	Downstream (pks/sec)	Upstream (pks/sec)	Total
64	40584	40584	81168
128	21478	21478	42956
256	11105	11105	22210
512	5547	5547	11094
1024	2826	2826	5652
1280	2269	2269	4538
1480	1967	1967	3934

# 8

## ETHERXTEND 3400 BRIDGE CONFIGURATION

This chapter explains EtherXtend 3400 bridge configuration:

- [Bridging overview, page 83](#)
- [Bridge enhancements to flood unknowns and multicasts, page 86](#)
- [Broadcasts and bridging, page 88](#)
- [VLANs, page 88](#)
- [Bridging behavior for untagged, tagged, and s-tagged, page 92](#)
- [Q-in-Q VLAN tagging, page 98](#)
- [Advanced bridging configurations, page 99](#)
- [Class of Service \(CoS\) in bridges, page 106](#)
- [Bandwidth limiting by port and service, page 107](#)
- [EtherXtend 3400 CO and CPE mode bridge scenarios, page 112](#)
- [EtherXtend 3400 bridge commands, page 118](#)

### Bridging overview

Bridges are configured with **bridge add** and the desired bridge type (uplink, downlink, intralink, tls for TLS, hub, and no type for transparent). This command creates a **bridge-interface-record** profile for the specified bridge interface and sets the default values for the profile based on the bridge type. The **bridge add** command also supports uplink and downlink bridges that use VLANs.

Refer to the *Zhone CLI Reference Guide* for a complete description of the command options and syntax.

Bridging involves configuring the EtherXtend 3400 to direct traffic based on Ethernet MAC addresses. The EtherXtend 3400 supports a variety of asymmetrical and symmetrical bridge types which provide different methods to learn, forward, and manipulate traffic.

- Asymmetrical bridge types are uplink, downlink, and intralink.
  - Uplink bridge

An uplink bridge uses one bridge interface in a VLAN as a default, and traffic from all other interfaces exits the system from this interface. As the default interface, packets entering the system on this interface do not have their source MAC addresses learned and associated with this interface. Traffic coming into this uplink interface is sent to the interface where the address has been learned. If the frame is a broadcast, it is filtered, unless it is an ARP or DHCP message that meets some special criteria. Unicasts received on an uplink port are forwarded to the downlink where the MAC address was learned.

Uplink bridge interfaces require an additional bridge-path configuration to set a default path for either a specific VLAN or globally for the system onto the uplink bridge. If an uplink is missing this configuration, traffic will not flow across the asymmetric VLAN.

– Downlink bridge

A downlink bridge is used in conjunction with an uplink bridge, where the uplink bridge is the path upstream to the network, and the downlink bridge is the learning interface facing subscribers. Traffic coming into this interface is forwarded to the uplink regardless of the destination MAC address. Broadcasts and unicasts (known and unknown) will be sent out the default interface, which is the uplink bridge for the VLAN.

Packets entering the system on this interface have their source MAC addresses learned and associated with this interface. Because this interface is not a default, it is required to learn MAC addresses, so that frames from the network that come in on the uplink bridge can be sent to the correct downlink bridge. Broadcasts received on a downlink are sent to the uplink (default) without filtering. Broadcasts will not flow to other downlinks as long as **forwardtodefault** parameter is set to true. Downlink ports learn MAC addresses.

– Intralink bridge

An intralink bridge is used in conjunction with an uplink bridge, where the uplink bridge is the path upstream to the network, and the intralink forwards traffic with unknown MAC addresses or multicasts to the configured bridge interface without attempting to learn the addresses of the attached devices or network. Traffic coming into this interface is forwarded to the uplink regardless of the destination MAC address. Broadcasts, multicasts, and unicasts (known and unknown) will be sent out the default interface, which is the uplink bridge for the VLAN.

Packets entering the system on this interface will not have their source MAC addresses learned since this interface is not used when a MAC is known.

Intralink bridge interfaces require an additional configuration to take effect, which is a bridge-path. The bridge-path sets a default intralink path for either a specific VLAN or a global intralink for the system onto the intralink bridge. If an intralink is missing this configuration, traffic will not flow across the asymmetric VLAN.

- Symmetrical bridge types are transparent, transparent LAN service (TLS), and hub.

- Transparent bridge

Transparent or untagged bridges which forward traffic based on MAC addresses but do not provide segregation of traffic. Traffic is broadcast over the Ethernet port and is either accepted or rejected based on the destination MAC address. There is no VLAN tagging; all ports are learning and forwarding without restriction and without broadcast suppression. Forwarding to a default port is not allowed.

- Transparent LAN service

A TLS bridge is used with only other TLS bridges. This should not be used with any asymmetrical bridges. TLS bridges learn MAC addresses and forward packets to learned destinations. Broadcasts and unknown unicasts are flooded out all interfaces except the ingress interface.

Packets entering the system on TLS interface have their source MAC addresses learned and associated with the interface so that frames from the network that come in on other TLS bridges in the VLAN can be sent to the correct interface.

- Hub bridge

A hub bridge is used with only other hub bridges. Hub bridges do not learn MAC addresses, but flood packets of all types to every other bridge interface in the VLAN, where all ports receive every frame received on the hub interface.

Packets entering the system on this interface do not have their source MAC addresses learned so that frames from the network that come in on other hub bridges in the VLAN can be sent to the correct interface.

Bridges also utilize VLAN tagging for tagged and untagged traffic segregation.

- Tagged bridging

Tagged or Virtual LANs (VLANs) bridging that forward traffic based on MAC addresses and allows the segregation of a single Ethernet network into multiple virtual network segments by mapping physical ports to VLAN IDs.

- Untagged bridging

Untagged or transparent bridging which forwards traffic based on MAC addresses but does not provide segregation of traffic. Traffic is broadcast over the Ethernet port and is either accepted or rejected based on the destination MAC address. There is no VLAN tagging; all ports are learning and forwarding without restriction without broadcast suppression. Forwarding to a default port is not allowed.

For transparent bridges, the type parameter is omitted to create bridges on the interfaces with default transparent bridge settings. In the **bridge add**, **bridge delete** commands, *<slot>* and *<port>* may be replaced with brackets containing numbers in series and/or (dash-separated) ranges; *<port>* may be replaced with wildcard '\*' for all ports on the card.

Refer to the *Zhone CLI Reference Guide* for a complete description of the command options and syntax.



**Note:** The EtherXtend 3400 ports can support both IP termination or bridging on different virtual circuits. However, each virtual circuit must be configured for either IP termination or bridging and cannot support both at the same time.



**Note:** When routed and bridged traffic is configured for the same uplink interface, VLAN tags must be used between both downlink ports and the uplink interface for traffic differentiation. For routed traffic, use the **ip-interface-record** profile to specify the VLAN ID.

---

## Bridge enhancements to flood unknowns and multicasts

Bridges are enhanced to enable VPN-like services using the `floodUnknowns` and `floodMulticast` parameters. These parameters enable the EtherXtend 3400 to forward unknown traffic to all bridge interfaces within the VLAN as follows:

- [FloodUnknown parameter on page 86](#)
- [FloodMulticast parameter on page 87](#)

### FloodUnknown parameter

The **FloodUnknown** parameter provides the ability to toggle the flooding of unknown unicast destination frames. When this parameter is set to *true*, the EtherXtend 3400 always forwards frames with an unknown unicast MAC if the bridge is set for forward to unicast. When this parameter is set to *false*, the EtherXtend 3400 always discards frames with an unknown unicast MAC if the bridge is set for forward to unicast. Any frame that does not find a match in the forwarding table will be discarded.

For transparent bridges, the default setting for this parameter is true. For uplink bridges, the default setting for this parameter is false.

## FloodMulticast parameter

The **FloodMulticast** parameter allows the EtherXtend 3400 to flood all multicast traffic received on a bridge out to all other ports in the VLAN. This is useful for architectures where the EtherXtend 3400 is acting as an aggregation point with no user interfaces. By default, this parameter is set to *false* for all bridge types.

When set to *true*, this parameter causes all multicast frames to be forwarded out all of the bridge interfaces within the VLAN, except the interface where the multicast was received.

To change a parameter, enter **update bridge-interface-record** *interface/type*:

```
zSH> update bridge-interface-record 1-1-201-0-n2nbond/bridge
bridge-interface-record 1-1-201-0-n2nbond/bridge
Please provide the following: [q]uit.
vpi: -----> {0}:
vci: -----> {0}:
vlanId: -----> {0}:
stripAndInsert: -----> {true}:
customARP: -----> {false}:
filterBroadcast: -----> {false}:
learnIp: -----> {false}:
learnUnicast: -----> {true}:
maxUnicast: -----> {100}:
learnMulticast: -----> {false}:
forwardToUnicast: -----> {true}:
forwardToMulticast: -----> {false}:
forwardToDefault: -----> {false}:
bridgeIfCustomDHCP: -----> {false}:
bridgeIfIngressPacketRuleGroupIndex: --> {0}:
vlanIdCOS: -----> {0}:
outgoingCOSOption: -----> {disable}:
outgoingCOSValue: -----> {0}:
s-tagTPID: -----> {0x8100}:
s-tagId: -----> {0}:
s-tagStripAndInsert: -----> {true}:
s-tagOutgoingCOSOption: -----> {s-tagdisable}:
s-tagIdCOS: -----> {0}:
s-tagOutgoingCOSValue: -----> {0}:
mcastControlList: -----> {}:
maxVideoStreams: -----> {0}:
isPPPoA: -----> {false}:
floodUnknown: -----> {true}:
floodMulticast: -----> {false}:true
bridgeIfEgressPacketRuleGroupIndex: --> {0}:
bridgeIfTableBasedFilter: -----> {NONE(0)}:
bridgeIfDhcpLearn: -----> {NONE(0)}:
.....
Save changes? [s]lave, [c]hange or [q]uit: s
Record created.
```

## Broadcasts and bridging

The EtherXtend 3400 supports a modified form of broadcast suppression when configured for bridge mode. The EtherXtend 3400 configures ports as the entered bridge type.

In general, broadcasts sent to a downlink will traverse the uplink, but will not be sent down other downlinks, even within the same VLAN. This prevents subscribers from maliciously or unintentionally sending or receiving broadcasts between ports on the same system.

Ports configured as uplinks will send broadcasts upstream, but by default will not propagate broadcasts sent from the upstream down to the EtherXtend 3400. The **filterBroadcast** parameter in the **bridge-interface-record** profile enables this filtering. This mechanism provides security benefits, as well as reducing unnecessary traffic on low bandwidth interfaces.

One exception to the operational mode described above is ARP broadcast support. When a EtherXtend 3400 receives a broadcast frame, it is checked to determine if it is an ARP protocol packet or not. If it is not, it is treated as above. If it is, then the EtherXtend 3400 compares and filters the requested IP address with the current forwarding table. If a match is found, the ARP broadcast is forwarded out the interface that has the appropriate host. This host will then reply to the ARP with a standard response. If a match is not found, then the ARP is filtered and it gets dropped as if it were a non-ARP broadcast. This setting is controlled by the **customARP** parameter.

Another exception to this broadcast filtering is DHCP broadcast support. When a EtherXtend 3400 receives a broadcast DHCP OFFER message from a remote DHCP server, if **customDHCP** is set to true, the broadcast messages are forwarded to the source MAC address. Otherwise, the broadcast DHCP messages are filtered.



**Note:** Ethernet interfaces can be addressed as either *eth* or *ethernetcsmacl*. The *eth* abbreviation is used in command output.

---

## VLANs

Figure 13 shows a typical VLAN configuration. On the access (subscriber) side, VLANs 1 and 2 are separate DSL networks connected to the EtherXtend 3400 via EtherXtend 3400 devices. On the uplink side, VLANs 1 and 2 are on the same physical Ethernet interface, but the traffic is separated based on the VLAN IDs.

The side of the connection closest to the subscriber is called the downlink interface. The upstream egress is called the uplink interface. When the EtherXtend 3400 is in VLAN mode, it adds (tags) the VLAN ID to the Ethernet frame on the uplink interface and strips (untags) the ID out on the downlink interface. Although VLAN IDs are not typically required on downlink interfaces, you can configure the downlink interface as tagged. Tagged downlink interfaces can be used for subtended EtherXtend 3400s or



subscribers expecting tagged traffic with Transparent LAN Server (TLS) service.

 **Note:** The EtherXtend 3400 supports VLAN IDs from 1 to 4096. Multiple VLAN interfaces can be added to the same physical port and VC.

**Figure 13: Typical VLAN network**

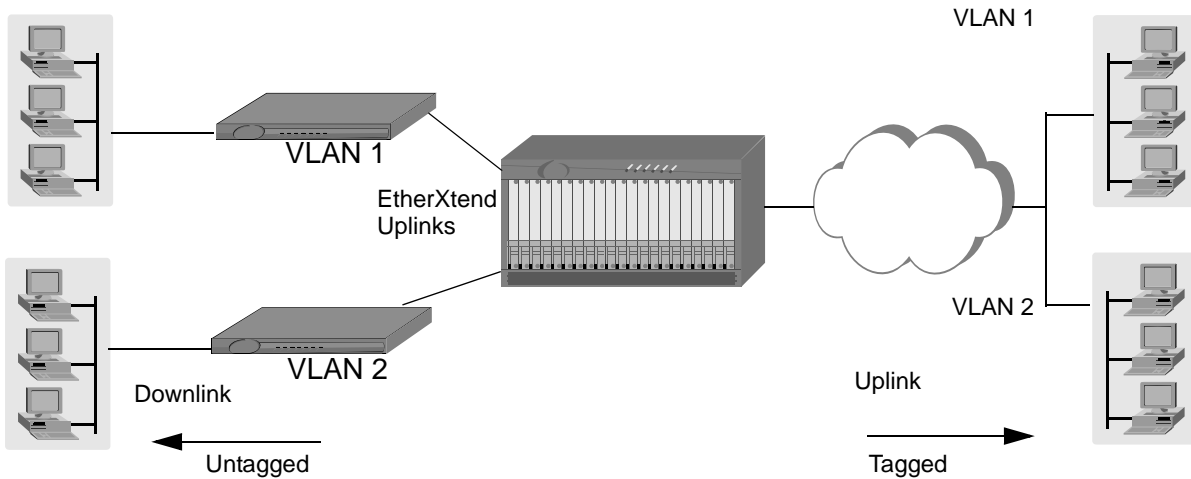

**Figure 14: Learning a MAC address**

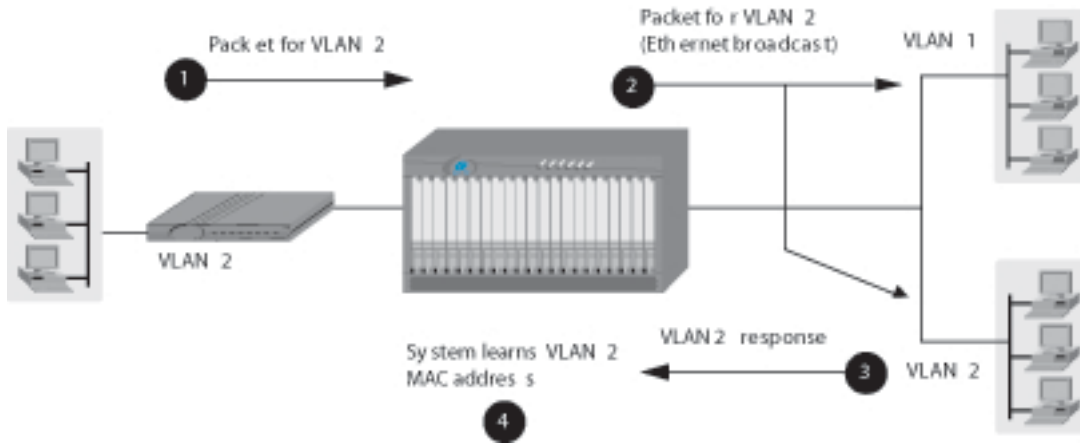

### Configuring bridges using VLANs

To configure a downstream bridge that directs traffic on a VLAN:

- 1 To add a bridge for the downstream connection, enter **bridge add 1-1-port-interface/type downlink vlan vlan id**. Multiple VLAN interfaces can be added to the same physical port and bond group.

```
zSH> bridge add 1-1-1-0/eth downlink vlan 60
```

This command adds a downlink to an Ethernet port on the LAN that uses VLAN 60.

- 2 To verify the bridge interface, enter **bridge-interface-record** *interface/type*:



**Note:** It is recommended not to change the default settings unless advanced bridge configuration is required.

```
zSH> get bridge-interface-record 1-1-1-0-eth/bridge
bridge-interface-record 1-1-1-0-eth/bridge
vpi: -----> {0}
vci: -----> {0}
vlanId: -----> {60}
stripAndInsert: -----> {true}
customARP: -----> {false}
filterBroadcast: -----> {false}
learnIp: -----> {false}
learnUnicast: -----> {true}
maxUnicast: -----> {100}
learnMulticast: -----> {false}
forwardToUnicast: -----> {true}
forwardToMulticast: -----> {false}
forwardToDefault: -----> {false}
bridgeIfCustomDHCP: -----> {false}
bridgeIfIngressPacketRuleGroupIndex: -> {0}
vlanIdCOS: -----> {0}
outgoingCOSOption: -----> {disable}
outgoingCOSValue: -----> {0}
s-tagTPID: -----> {0x8100}
s-tagId: -----> {0}
s-tagStripAndInsert: -----> {true}
s-tagOutgoingCOSOption: -----> {s-tagdisable}
s-tagIdCOS: -----> {0}
s-tagOutgoingCOSValue: -----> {0}
mcastControlList: -----> {}
maxVideoStreams: -----> {0}
isPPPoA: -----> {false}
floodUnknown: -----> {true}
floodMulticast: -----> {true}
bridgeIfEgressPacketRuleGroupIndex: --> {0}
bridgeIfTableBasedFilter: -----> {NONE(0)}
bridgeIfDhcpLearn: -----> {NONE(0)}
```

- 3 To create a bridge interface on the WAN bond group for the upstream connection, enter **bridge add** *1-1-bondgroup-0/type uplink vlan id*:

```
zSH> bridge add 1-1-201-0/efmbond uplink vlan 1
```

This creates a bridge interface on the WAN bond group interface.

- 4 To create a bridge path for this uplink, enter **bridge-path add 1-1-bondgroup-0-interface/type global**:

```
zSH> bridge-path add 1-1-201-0-efmbond/bridge global
```

The **global** setting specifies that the EtherXtend 3400 should send all VLAN traffic to this port. A VLAN ID can also be used when the EtherXtend 3400 should send only traffic from a specific VLAN ID to this port. It is recommended not to change the default settings unless advanced bridge configuration is required.

```
fm1> get bridge-interface-record 1-1-201-0-efmbond/bridge
bridge-interface-record 1-1-201-0-efmbond/bridge
vpi: -----> {0}
vci: -----> {0}
vlanId: -----> {0}
stripAndInsert: -----> {true}
customARP: -----> {false}
filterBroadcast: -----> {false}
learnIp: -----> {false}
learnUnicast: -----> {true}
maxUnicast: -----> {100}
learnMulticast: -----> {false}
forwardToUnicast: -----> {true}
forwardToMulticast: -----> {false}
forwardToDefault: -----> {false}
bridgeIfCustomDHCP: -----> {false}
bridgeIfIngressPacketRuleGroupIndex: -> {0}
vlanIdCOS: -----> {0}
outgoingCOSOption: -----> {disable}
outgoingCOSValue: -----> {0}
s-tagTPID: -----> {0x8100}
s-tagId: -----> {0}
s-tagStripAndInsert: -----> {true}
s-tagOutgoingCOSOption: -----> {s-tagdisable}
s-tagIdCOS: -----> {0}
s-tagOutgoingCOSValue: -----> {0}
mcastControlList: -----> {}
maxVideoStreams: -----> {0}
isPPPoA: -----> {false}
floodUnknown: -----> {true}
floodMulticast: -----> {true}
bridgeIfEgressPacketRuleGroupIndex: --> {0}
bridgeIfTableBasedFilter: -----> {NONE(0)}
bridgeIfDhcpLearn: -----> {NONE(0)}
```



**Note:** To delete a downlink bridge with a VLAN, the VLAN ID must be specified in the **bridge delete** command.

## Bridging behavior for untagged, tagged, and s-tagged

This section provides a discussion and examples of various types of bridges and their settings:

- [Overview on page 92](#)
- [Untagged bridging examples on page 93](#)
- [Tagged and s-tagged bridging examples on page 95](#)

### Overview

Bridges also utilize VLAN and SLAN tagging for untagged, tagged, and s-tagged, traffic segregation.

- **Untagged bridging**

Untagged or transparent bridging accepts and sends traffic based on MAC addresses but does not provide traffic segregation. Traffic is broadcast over the Ethernet port and is either accepted or rejected based on the destination MAC address. There is no VLAN tagging; all ports are learning and forwarding without restriction, without broadcast suppression. Forwarding to a default port is not allowed. If bridge forwarding selects a single or double-tagged egress interface, the configured VLAN and SLAN tags will be inserted in to packets destined for this interface. Only non-zero values are recommended for VLAN and SLAN settings of untagged bridges.
- **Tagged bridging**

Tagged or Virtual LANs (VLANs) bridging, accepts single-tagged packets based on MAC addresses and allows the segregation of a single Ethernet network into multiple virtual network segments by mapping packets based on the VLAN ID. If a non-zero VLAN ID is configured, the interface accepts only tagged packets matching this VLAN ID. If a VLAN of 0 (zero) is configured, the interface accepts all VLAN tagged packets not matching any configured VLANs on the same interface.

A configured SLAN tag is inserted into outgoing packets when bridge forwarding selects a double-tagged egress interface. Only non-zero SLAN values are recommended for tagged bridges.
- **s-tagged**

Double-tagged or Service LANs (SLANs) bridging, accepts and sends double-tagged traffic based on MAC addresses and allows the segregation of a single Ethernet network into multiple virtual network segments by mapping packets based on VLAN ID and SLAN ID. If non-zero VLAN ID and SLAN ID are configured, the interface accepts and sends only tagged packets matching both VLAN ID and SLAN ID. If a VLAN of 0 (zero) is configured with a non-zero SLAN ID, the interface accepts and sends only double-tagged packets matching the SLAN and any VLAN tagged packets not destined to another client on the same interface.

When both the VLAN and SLAN tags are zero (0), the bridge accepts all single or double tagged packets not destined to another client on the same interface.

## Untagged bridging examples

Configuring untagged or transparent bridging allows traffic to be forwarded from a downlink interface through the EtherXtend 3400 uplink interface based on the destination MAC address without tagging or modification to the frame. Refer to the *Zhone CLI Reference Guide* for a complete description of the command options and syntax.



**Note:** Ethernet interfaces can be addressed as either *eth* or *ethernetcsmacd*. The *eth* abbreviation is used in command output.

### Configuring an untagged bridge

To add an untagged bridge:

- 1 To add an untagged bridge to the upstream SHDSL interface, enter **bridge add interface/type**:

```
zSH> bridge add 1-1-40-0/efmbond
Adding bridge on 1-1-40-0/efmbond
Created bridge-interface-record 1-1-40-0-efmbond-0/bridge
```

This example adds a default transparent bridge interface to the SHDSL card on the MALC and sets the parameters to the default transparent bridge interface settings.

The following example shows the default **bridge-interface-record** settings defaults. It is recommended not to change the default settings unless advanced bridge configuration is required. To view the defaults, enter **get bridge-interface-record interface/type**:

```
zSH> get bridge-interface-record 1-1-40-0-efmbond-0/bridge
bridge-interface-record 1-1-40-0-efmbond-0/bridge
vpi: -----> {0}
vci: -----> {0}
vlanId: -----> {0}
stripAndInsert: -----> {false}
customARP: -----> {true}
filterBroadcast: -----> {true}
learnIp: -----> {false}
learnUnicast: -----> {false}
maxUnicast: -----> {0}
learnMulticast: -----> {false}
forwardToUnicast: -----> {true}
forwardToMulticast: -----> {true}
forwardToDefault: -----> {false}
bridgeIfCustomDHCP: -----> {true}
bridgeIfIngressPacketRuleGroupIndex: -> {0}
```

```

vlanIdCOS: -----> {0}
outgoingCOSOption: -----> {disable}
outgoingCOSValue: -----> {0}
s-tagTPID: -----> {0x8100}
s-tagId: -----> {0}
s-tagStripAndInsert: -----> {true}
s-tagOutgoingCOSOption: -----> {s-tagdisable}
s-tagIdCOS: -----> {0}
s-tagOutgoingCOSValue: -----> {0}
mcastControlList: -----> {
maxVideoStreams: -----> {0}
isPPPoA: -----> {false}
floodUnknown: -----> {false}
floodMulticast: -----> {false}
bridgeIfEgressPacketRuleGroupIndex: --> {0}
bridgeIfTableBasedFilter: -----> {NONE(0)}
bridgeIfDhcpLearn: -----> {NONE(0)}

```

- 2 To add a transparent bridge that accepts transparent/untagged traffic on the EtherXtend 3400 units's downstream Ethernet port, enter **bridge add interface/type**:

```

zSH> bridge add 1-1-3-0/eth
Adding bridge on 1-1-3-0/eth
Created bridge-interface-record 1-1-3-0-eth/bridge

```

- 3 To show the default transparent **bridge-interface-record** settings for the uplink, enter **get bridge-interface-record interface/type**. Unless advanced bridge configuration is required, it is recommended not to change the default settings.

```

zSH> get bridge-interface-record 1-1-3-0-eth/bridge
bridge-interface-record 1-1-3-0-eth/bridge
vpi: -----> {0}
vci: -----> {0}
vlanId: -----> {0}
stripAndInsert: -----> {true}
customARP: -----> {false}
filterBroadcast: -----> {false}
learnIp: -----> {false}
learnUnicast: -----> {true}
maxUnicast: -----> {5}
learnMulticast: -----> {false}
forwardToUnicast: -----> {true}
forwardToMulticast: -----> {false}
forwardToDefault: -----> {false}
bridgeIfCustomDHCP: -----> {false}
bridgeIfIngressPacketRuleGroupIndex: -> {0}
vlanIdCOS: -----> {0}
outgoingCOSOption: -----> {disable}
outgoingCOSValue: -----> {0}
s-tagTPID: -----> {0x8100}
s-tagId: -----> {0}

```

```

s-tagStripAndInsert: -----> {true}
s-tagOutgoingCOSOption: -----> {s-tagdisable}
s-tagIdCOS: -----> {0}
s-tagOutgoingCOSValue: -----> {0}
mcastControlList: -----> {}
maxVideoStreams: -----> {0}
isPPPoA: -----> {false}
floodUnknown: -----> {false}
floodMulticast: -----> {false}
bridgeIfEgressPacketRuleGroupIndex: --> {0}
bridgeIfTableBasedFilter: -----> {NONE(0)}
bridgeIfDhcpLearn: -----> {NONE(0)}

```

4 To verify that both sides of the bridge are present, enter:

```

zSH> bridge show

```

Typ	VLAN	Bridge	St	Table	Data
	0	1-1-40-0-efmbond/bridge	UP	D	00:00:00:00:a5:03
	0	1-1-3-0-eth/bridge	UP	D	00:00:00:00:05:03

## Tagged and s-tagged bridging examples

When adding bridges for VLAN tagged (single tagged) bridges, the bridge interface name includes the VLAN ID, even when the default VLAN ID of 0 is not explicitly added. By entering **bridge add interface/type**, the 0 is automatically included:

```

zSH> bridge add 1-1-1-0/eth tagged
Adding bridge on 1-1-1-0/eth
Created bridge-interface-record 1-1-1-0-eth-0/bridge

```

Entering **bridge add interface/type vlan 4000 tagged** shows a tagged bridge with VLAN 4000:

```

zSH> bridge add 1-1-1-0/eth vlan 4000 tagged
Adding bridge on 1-1-1-0/eth
Created bridge-interface-record 1-1-1-0-eth-4000/bridge

```

```

zSH> bridge add 1-1-1-0/eth vlan 1000 slan 17 tagged
Adding bridge on 1-1-1-0/eth
Created bridge-interface-record 1-1-1-0-eth-1000/bridge

```

Enter **bridge show** to view the bridges just created:

```

zSH> bridge show

```

Typ	VLAN	Bridge	St	Table	Data
dwn	123	1-1-4-0-eth/bridge	UP	D	00:1a:6d:13:19:8f
					S VLAN 123 default [U: 3600 sec, M: 150 sec, I: 0 sec]
dwn	123	1-1-40-0-efmbond/bridge	UP	S	VLAN 123 default [U: 3600 sec, M: 150 sec, I: 0 sec]
	Tagged	1-1-1-0-eth-0/bridge	DWN		
	Tagged 4000	1-1-1-0-eth-4000/bridge	DWN		

## Bridge profile

Table 21 describes the parameters in the **bridge-interface-record** that are used for Ethernet CoS support.

**Table 21: bridge-interface-record parameters for Ethernet CoS support**

Parameter	Description
<b>vlanIdCOS</b>	Specifies the value loaded into the CoS field of the VLAN header when an untagged packet received on this interface is tagged (VLAN ID inserted) for bridging. Value range is 0 to 7. Default is 0.
<b>outgoingCOSOption</b>	Specifies whether to insert the VLAN CoS bits on packets bridged through this interface. Values: <b>Disable</b> Leave any existing CoS values unchanged. This is the default value. <b>All</b> Replace the current CoS values in all VLAN headers in tagged and untagged packets originating and transported through this device.
<b>outgoingCOSValue</b>	For outgoing tagged packets, specifies the value used to overwrite any existing CoS value in the VLAN header. Value range is 0 to 7. Default is 0.

To display the **bridge-interface-record** profile, enter **show bridge-interface-record**:

```
zSH> show bridge-interface-record
vpi:-----> {0 - 4095}
vci:-----> {0 - 65535}
vlanId:-----> {0 - 2147483647}
stripAndInsert:-----> false true
customARP:-----> false true
filterBroadcast:-----> false true
learnIp:-----> false true
learnUnicast:-----> false true
maxUnicast:-----> {0 - 2147483647}
learnMulticast:-----> false true
forwardToUnicast:-----> false true
forwardToMulticast:-----> false true
forwardToDefault:-----> false true
bridgeIfCustomDHCP:-----> false true
bridgeIfIngressPacketRuleGroupIndex:-> {0 - 2147483647}
vlanIdCOS:-----> {0 - 7}
outgoingCOSOption:-----> disable all
outgoingCOSValue:-----> {0 - 7}
s-tagTPID:-----> {33024 - 37376}
s-tagId:-----> {0 - 4095}
```



```

s-tagStripAndInsert:-----> false true
s-tagOutgoingCOSOption:-----> s-tagdisable s-tagall
s-tagIdCOS:-----> {0 - 7}
s-tagOutgoingCOSValue:-----> {0 - 7}
mcastControlList:-----> {264}
maxVideoStreams:-----> {0 - 210}
isPPPoA:-----> false true
floodUnknown:-----> false true
floodMulticast:-----> false true
bridgeIfEgressPacketRuleGroupIndex:--> {0 - 2147483647}
bridgeIfTableBasedFilter:-----> none+mac+ip
bridgeIfDhcpLearn:-----> none+mac+ip

```

To modify a parameter in the bridge-interface-record such as the CoS, enter **update bridge-interface-record** *interface/type* and make the changes.

```

zSH> update bridge-interface-record 1-1-3-0-eth/bridge
bridge-interface-record 1-1-3-0-eth/bridge
Please provide the following: [q]uit.
vpi: -----> {0}:
vci: -----> {0}:
vlanId: -----> {800}:
stripAndInsert: -----> {true}:
customARP: -----> {false}:
filterBroadcast: -----> {false}:
learnIp: -----> {true}:
learnUnicast: -----> {true}:
maxUnicast: -----> {5}:
learnMulticast: -----> {true}:
forwardToUnicast: -----> {false}:
forwardToMulticast: -----> {false}:
forwardToDefault: -----> {true}:
bridgeIfCustomDHCP: -----> {false}:
bridgeIfIngressPacketRuleGroupIndex: -> {0}:
vlanIdCOS: -----> {0}:
outgoingCOSOption: -----> {disable}:
outgoingCOSValue: -----> {0}:
s-tagTPID: -----> {0x8100}:
s-tagId: -----> {0}:
s-tagStripAndInsert: -----> {true}:
s-tagOutgoingCOSOption: -----> {s-tagdisable}:
s-tagIdCOS: -----> {0}:
s-tagOutgoingCOSValue: -----> {0}:
mcastControlList: -----> {2}:
maxVideoStreams: -----> {1}:
isPPPoA: -----> {false}:
floodUnknown: -----> {false}:
floodMulticast: -----> {false}:
bridgeIfEgressPacketRuleGroupIndex: --> {0}:
bridgeIfTableBasedFilter: -----> {NONE(0)}:
bridgeIfDhcpLearn: -----> {NONE(0)}:
.....
Save changes? [s]ave, [c]hange or [q]uit:

```

## Q-in-Q VLAN tagging

The IEEE 802.1ad (also known as Q-in-Q VLAN tagging) expands the VLAN space in the Ethernet frame to support the tagging of previously tagged packets. This second tag (SLAN) creates a "double-tagged" Ethernet frame. The double-tagged Ethernet frame enables service providers to offer additional services, such as Internet access on specific SLANs for specific customers, while still providing single-tagged VLAN services.

The EtherXtend 3400 also supports setting CoS values in the Ethernet SLAN headers for bridged packets. This service enables you to assign a service level or class of service (CoS) to an Ethernet SLAN that is transported across a uplink, intralink, or downlinked s-tagged bridge. The configured CoS level specifies the packet priority and queuing methods used to transport the packet through the Ethernet network. The EtherXtend 3400 sets and preserves the CoS settings to ensure these settings are passed to other Ethernet devices in the network for QOS processing.



**Note:** Ethernet interfaces can be addressed as either *eth* or *ethernetcsma*. The *eth* abbreviation is used in command output.

For Q-in-Q VLAN tagging, the bridge profile supports the following parameters:

- **s-tagTPID**  
Identifies the type of VLAN ID used. Typically set to 8100.
- **s-tagID**  
Specifies the SLAN ID assigned to an Ethernet frame.
- **s-tagStripAndInsert**  
Specifies whether to strip and insert s-tag values in Ethernet frames received and transmitted on the bridge interface.
- **s-tagOutgoingCOSOption**  
Specifies whether to insert CoS value bits on outgoing s-tag packets.
- **s-tagIDCOS**  
Specifies the CoS ID associated with the SLAN ID
- **s-tagOutgoingCOSValue**  
Specifies the value used to overwrite any existing CoS value in outgoing s-tag packets.

The **bridge add** command supports adding s-tag IDs from the command line. This example adds interface *1-1-2-0/eth downlink* with VLAN 100, SLAN 200, CoS value of 7 and sCoS value of 6.

```
zSH> bridge add 1-1-2-0/eth downlink vlan 100 slan 200 tagged cos 7 scos 6
Adding bridge on 1-1-2-0/eth
Created bridge-interface-record 1-1-2-0-eth-100/bridge
```

To display the **bridge-interface-record** profile, enter the **get bridge-interface-record**.

```
zSH> get bridge-interface-record 1-1-2-0-eth-100/bridge
bridge-interface-record 1-1-2-0-eth-100/bridge
vpi: -----> {0}
vci: -----> {0}
vlanId: -----> {100}
stripAndInsert: -----> {false}
customARP: -----> {false}
filterBroadcast: -----> {false}
learnIp: -----> {true}
learnUnicast: -----> {true}
maxUnicast: -----> {5}
learnMulticast: -----> {true}
forwardToUnicast: -----> {false}
forwardToMulticast: -----> {false}
forwardToDefault: -----> {true}
bridgeIfCustomDHCP: -----> {false}
bridgeIfIngressPacketRuleGroupIndex: --> {0}
vlanIdCOS: -----> {7}
outgoingCOSOption: -----> {disable}
outgoingCOSValue: -----> {0}
s-tagTPID: -----> {0x8100}
s-tagId: -----> {200}
s-tagStripAndInsert: -----> {true}
s-tagOutgoingCOSOption: -----> {s-tagdisable}
s-tagIdCOS: -----> {6}
s-tagOutgoingCOSValue: -----> {0}
mcastControlList: -----> {}
maxVideoStreams: -----> {0}
isPPPoA: -----> {false}
floodUnknown: -----> {false}
floodMulticast: -----> {false}
bridgeIfEgressPacketRuleGroupIndex: --> {0}
bridgeIfTableBasedFilter: -----> {NONE(0)}
bridgeIfDhcpLearn: -----> {NONE(0)}
```

## Advanced bridging configurations

The default settings for bridge interfaces are created based on the usage of the downlink and uplink parameters of the **bridge add** command. It is recommended not to change the default settings unless advanced bridge configuration is required. Examples of advanced bridge configurations include:

- [Packet-rule records \(Option 82, Forbid OUI, DHCP relay\) on page 100](#)
- [VLAN ID stripandInsert parameter on page 102](#)
- [Broadcast suppression on page 103](#)
- [Bridge with DHCP relay on page 104](#)

Refer to the *Zhone CLI Reference Guide* for a complete description of the command options and syntax.

## Packet-rule records (Option 82, Forbid OUI, DHCP relay)

The EtherXtend 3400 supports packet-rule records so an open-ended number of filter settings can be configured for on a uplink or downlink bridge interface. The same filter settings can also be easily applied to multiple bridge interfaces.

Packet-rule-records are typically assigned to bridge configuration groups on downlink bridge interfaces. Each bridge configuration record contains settings for type and value. The **packetRuleValue** parameter specifies the type of filter to be applied to the interface. The following interfaces can be applied to EtherXtend 3400 bridge interfaces:

- **bridgeinsertoption82:**  
**packetRuleValue** contains an identification text used with Insert option 82 to identify the DHCP host. When this option is specified, option82 information is displayed in standard text format.
- **bridgedhcprelay**  
**packetRuleValue** contains the DHCP subnet group ID. If only the DHCP relay option is used, option82 information is displayed in hex format as *slot port shelf vlan*.
- **bridgeforbidoui**  
**packetRuleValue** contains a 3-byte hexadecimal vendor code used with the Forbid OUI to forbid access on the interface.

Enter **packet-rule-record** to view the interface types available. EtherXtend 3400 supports **bridgeinsertoption82**, **bridgedhcprelay**, and **bridgeforbidoui**.

```
zSH> show packet-rule-record
packetRuleType:---> bridgeinsertoption82 bridgedhcprelay
bridgeinsertpppoevendortag bridgeforbidoui ratelimitdiscard
packetRuleValue:--> {260}
packetRuleValue2:-> {260}
packetRuleValue3:-> {260}
packetRuleValue4:-> {260}
packetRuleValue5:-> {260}
```

The **bridge-interface-record** profile contains the fields to support the packet-rule-record.

```
zSH> show bridge-interface-record
bridgeIfIngressPacketRuleGroupIndex:--> {0 - 2147483647}
bridgeIfEgressPacketRuleGroupIndex:--> {0 - 2147483647}
```



**Note:** Bridge configuration record settings supersede the global filter settings set using the **bridge-path add filter** command.

## Configuring bridge interface record

Configure the **bridge-interface-record** to a given bridge configuration group to a specified interface. Bridge configuration groups are assigned to the interface records by setting the **bridgeIfConfigGroupIndex** parameter.

To configure a bridge configuration group:

```
zSH> update bridge-interface-record 1-1-40-0-efmbond/bridge
bridge-interface-record 1-1-40-0-efmbond/bridge
Please provide the following: [q]uit.
vpi: -----> {0}:
vci: -----> {0}:
vlanId: -----> {123}:
stripAndInsert: -----> {true}:
customARP: -----> {false}:
filterBroadcast: -----> {false}:
learnIp: -----> {true}:
learnUnicast: -----> {true}:
maxUnicast: -----> {5}:
learnMulticast: -----> {true}:
forwardToUnicast: -----> {false}:
forwardToMulticast: -----> {false}:
forwardToDefault: -----> {true}:
bridgeIfCustomDHCP: -----> {false}:
bridgeIfIngressPacketRuleGroupIndex: -> {0}:1
vlanIdCOS: -----> {0}:
outgoingCOSOption: -----> {disable}:
outgoingCOSValue: -----> {0}:
s-tagTPID: -----> {0x8100}:
s-tagId: -----> {0}:
s-tagStripAndInsert: -----> {true}:
s-tagOutgoingCOSOption: -----> {s-tagdisable}:
s-tagIdCOS: -----> {0}:
s-tagOutgoingCOSValue: -----> {0}:
mcastControlList: -----> {}:
maxVideoStreams: -----> {0}:
isPPPoA: -----> {false}:
floodUnknown: -----> {false}:
floodMulticast: -----> {false}:
bridgeIfEgressPacketRuleGroupIndex: --> {0}:
bridgeIfTableBasedFilter: -----> {NONE(0)}:
bridgeIfDhcpLearn: -----> {NONE(0)}:
.....
Save changes? [s]ave, [c]hange or [q]uit: s
Record updated.
```

## Configuring packet rule records

Create bridge configuration records using the **packet-rule-record** profile. Enter the group/instance index numbers to assign group and instance identification.

Configure a new **packet-rule-record** for *group/instance* and specify either `bridgeinsertoption82`, `bridgedhcprelay`, or `bridgeforbidoui`. Also specify the packet rule values (a string of information you want traced). For example:

```
zSH> new packet-rule-record 1/1
packet-rule-record 1/1
Please provide the following: [q]uit.
packetRuleType: ---> {bridgeinsertoption82}:
packetRuleValue: --> {}:00:02:02
packetRuleValue2: -> {}:
packetRuleValue3: -> {}:
packetRuleValue4: -> {}:
packetRuleValue5: -> {}:
.....
Save new record? [s]ave, [c]hange or [q]uit: s
Record created.
```

## VLAN ID stripAndInsert parameter

In most configurations, VLAN IDs should be stripped for traffic destined to downlink interfaces and inserted for traffic destined for upstream interfaces. Downlink interfaces typically do not need to know the VLAN ID since they are on a single Ethernet. You can, however, specify that a downlink interface be tagged, or an uplink interface be untagged. You might want to do this if you are subtending EtherXtend 3400 devices and aggregating Ethernet traffic.

## Configuring stripAndInsert

Configure the **bridge-interface-record** to change the stripping and insert of VLAN tags for a specified interface on the downlink:

To change the **stripAndInsert** option:

```
zSH> update bridge-interface-record 1-1-2-0-eth/bridge
bridge-interface-record 1-1-2-0-eth/bridge
Please provide the following: [q]uit.
vpi: -----> {0}:
vci: -----> {0}:
vlanId: -----> {4094}
stripAndInsert: -----> {true}: false
customARP: -----> {false}:
filterBroadcast: -----> {false}:
learnIp: -----> {false}:
learnUnicast: -----> {true}:
maxUnicast: -----> {5}:
learnMulticast: -----> {false}:
```

```

forwardToUnicast: -----> {true}:
forwardToMulticast: -----> {false}:
forwardToDefault: -----> {false}:
bridgeIfCustomDHCP: -----> {false}:
bridgeIfIngressPacketRuleGroupIndex: -> {0}:
vlanIdCOS: -----> {0}:
outgoingCOSOption: -----> {disable}:
outgoingCOSValue: -----> {0}:
s-tagTPID: -----> {0x8100}:
s-tagId: -----> {4094}:
s-tagStripAndInsert: -----> {true}:
s-tagOutgoingCOSOption: -----> {s-tagdisable}:
s-tagIdCOS: -----> {0}:
s-tagOutgoingCOSValue: -----> {0}:
mcastControlList: -----> {}:
maxVideoStreams: -----> {0}:
isPPPoA: -----> {false}:
floodUnknown: -----> {false}:
floodMulticast: -----> {false}:
bridgeIfEgressPacketRuleGroupIndex: --> {0}:
bridgeIfTableBasedFilter: -----> {NONE(0)}:
bridgeIfDhcpLearn: -----> {NONE(0)}:
.....
Save changes? [s]ave, [c]hange or [q]uit: s
Record updated.

```

## Broadcast suppression

Broadcast suppression enables DHCP information to be relayed between DHCP client and host while broadcast filtering is enabled.

### CustomDHCP setting

The customDHCP setting enables bridge interfaces to pass DHCP information independent of the filterBroadcast setting. Setting customDHCP to TRUE will cause that bridge interface to pass DHCP OFFER and ACK packets even though the filterBroadcast is set to TRUE.

To enable CustomDHCP:

For an existing bridge, update the bridge-interface-record and enter **update bridge-interface-record** *interface/type*.

```

zSH> update bridge-interface-record 1-1-2-0-eth/bridge
bridge-interface-record 1-1-2-0-eth/bridge
Please provide the following: [q]uit.
vpi: -----> {0}:
vci: -----> {0}:
vlanId: -----> {4094}:
stripAndInsert: -----> {false}:
customARP: -----> {false}:
filterBroadcast: -----> {false}:
learnIp: -----> {false}:

```

```

learnUnicast: -----> {true}:
maxUnicast: -----> {5}:
learnMulticast: -----> {false}:
forwardToUnicast: -----> {true}:
forwardToMulticast: -----> {false}:
forwardToDefault: -----> {false}:
bridgeIfCustomDHCP: -----> {false}: true
bridgeIfIngressPacketRuleGroupIndex: -> {0}:
vlanIdCOS: -----> {0}:
outgoingCOSOption: -----> {disable}:
outgoingCOSValue: -----> {0}:
s-tagTPID: -----> {0x8100}:
s-tagId: -----> {4094}:
s-tagStripAndInsert: -----> {true}:
s-tagOutgoingCOSOption: -----> {s-tagdisable}:
s-tagIdCOS: -----> {0}:
s-tagOutgoingCOSValue: -----> {0}:
mcastControlList: -----> {}:
maxVideoStreams: -----> {0}:
isPPPoA: -----> {false}:
floodUnknown: -----> {false}:
floodMulticast: -----> {false}:
bridgeIfEgressPacketRuleGroupIndex: --> {0}:
bridgeIfTableBasedFilter: -----> {NONE(0)}:
bridgeIfDhcpLearn: -----> {NONE(0)}:
.....
Save changes? [s]lave, [c]hange or [q]uit: s
Record updated.

```

## Bridge with DHCP relay

The EtherXtend 3400 enables bridges to be configured as DHCP relay agents. All DHCP messages on the bridge will have Option 82 information inserted and be passed up through an IP interface to a external DHCP server.

Figure 15 illustrates the traffic flow when the EtherXtend 3400 is configured with bridges to support DHCP relay.

Figure 15: Bridge supported DHCP relay

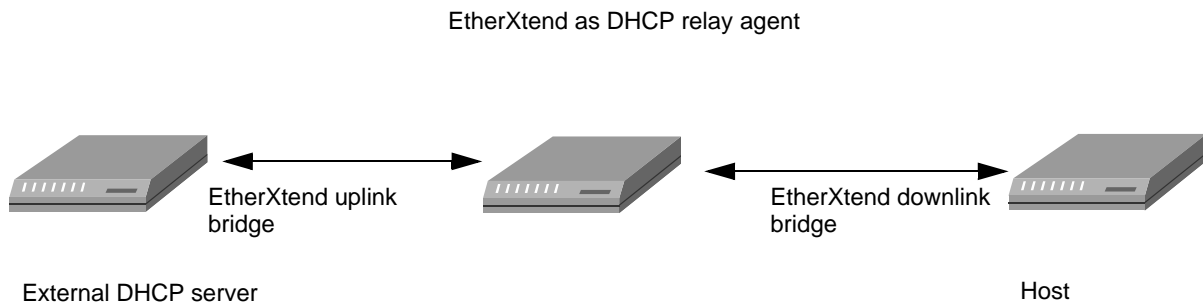



## Configuring bridges to support DHCP relay

This procedure describes how to configure bridges on the EtherXtend 3400 to support DHCP relay. This procedure assumes the following configuration has already been performed on the EtherXtend 3400.

- Downlink bridge to the host
- Uplink bridge to network
- IP interface on the EtherXtend 3400 with a route available to the DHCP server

To configure bridge support for DHCP relay:

- 1 Configure the **packet-rule-record** using the group number of the bridge and add the record to either the **bridgeIfIngressPacketRuleGroupIndex** interface or the **bridgeIfEgressPacketRuleGroupIndex** interface depending on the type of bridge.

```
zSH> new packet-rule-record 1/1
packet-rule-record 1/1
Please provide the following: [q]uit.
packetRuleType: ---> {bridgeinsertoption82}: bridgedhcprelay
packetRuleValue: --> {}: 1 [dhcp-server-subnet index]
packetRuleValue2: -> {}:
packetRuleValue3: -> {}:
packetRuleValue4: -> {}:
packetRuleValue5: -> {}:
.....
Save new record? [s]lave, [c]hange or [q]uit: s
Record saved
```

- 2 Verify that the **bridge-interface-record** contains correct **bridgeIfConfigGroupIndex** value. This value represents the bridge configuration group index specified for the bridge-config-record.

```
zSH> get bridge-interface-record 1-1-4-0-eth/bridge
vpi: -----> {0}
vci: -----> {35}
vlanId: -----> {0}
stripAndInsert: -----> {true}
customARP: -----> {false}
filterBroadcast: -----> {false}
learnIp: -----> {true}
learnUnicast: -----> {true}
maxUnicast: -----> {5}
learnMulticast: -----> {true}
forwardToUnicast: -----> {false}
forwardToMulticast: -----> {false}
forwardToDefault: -----> {true}
bridgeIfCustomDHCP: -----> {false}
bridgeIfConfigGroupIndex: -> {1} bridge-config-records 1/1, 2/2, etc.
vlanIdCOS: -----> {0}
outgoingCOSOption: -----> {disable}
outgoingCOSValue: -----> {0}
```

```

s-tagTPID: -----> {0x8100}
s-tagId: -----> {0}
s-tagStripAndInsert: -----> {false}
s-tagOutgoingCOSOption: ----> {s-tagdisable}
s-tagIdCOS: -----> {0}
s-tagOutgoingCOSValue: ----> {0}

```

Verify the **dhcp-server-subnet** with subnetgroup index matching the **bridge-ConfigValue** is configured to forward DHCP requests to the desired external DHCP server. In this example, the **bridgeConfigValue** of *1* in the **bridge-config-record** matches the subnetgroup value specified in the **dhcp-server-subnet** profile. These values tell the DHCP relay agent to send the DHCP packets to the specified DHCP external server at 172.16.88.73.

```

zSH> get dhcp-server-subnet 1
network: -----> {10.11.1.0}
netmask: -----> {255.255.255.0}
domain: -----> {0}
range1-start: -----> {10.11.1.10}
range1-end: -----> {10.11.1.250}
range2-start: -----> {0.0.0.0}
range2-end: -----> {0.0.0.0}
range3-start: -----> {0.0.0.0}
range3-end: -----> {0.0.0.0}
range4-start: -----> {0.0.0.0}
range4-end: -----> {0.0.0.0}
default-lease-time: ----> {-1}
min-lease-time: -----> {-1}
max-lease-time: -----> {-1}
boot-server: -----> {0.0.0.0}
bootfile: -----> {}
default-router: -----> {10.11.1.1}
primary-name-server: ----> {0.0.0.0}
secondary-name-server: -> {0.0.0.0}
domain-name: -----> {}
subnetgroup: -----> {1} matches bridgeConfigValue of 1 in the bridge-config-record
stickyaddr: -----> {enable}
external-server: -----> {172.16.88.73}

```

## Class of Service (CoS) in bridges

The EtherXtend 3400 supports setting CoS values in Ethernet VLAN headers for bridged packets. This service enables you to assign a service level or class of service (CoS) to an Ethernet VLAN interface that is transported across a uplink, intralink, or downlinked tagged bridge. The configured CoS level specifies the packet priority and queuing methods used to transport the packet through the Ethernet network. The EtherXtend 3400 sets and preserves the CoS settings to ensure these settings are passed to other Ethernet devices in the network for QoS processing.

## Bandwidth limiting by port and service



**Note:** Rate limiting on the EtherXtend 3400 is supported only in the egress direction on both the SHDSL ports and Ethernet ports.

Rate limiting is typically used when a service provider needs to provide customer services with limited bandwidth and needs to create a priority for which type of packets — data, voice, or video — have priority when there is bandwidth contention. In other words, a service provider may need to ensure that video traffic get to the user at the expense of data or voice traffic.

You use rate limiting to control the rate of traffic sent or received on the ingress or the egress of both the logical port or the physical port on the EtherXtend 3400. Traffic that is less than or equal to the specified rate is sent and traffic that exceeds the rate is dropped or delayed.

After configuring an interface with rate limiting, the traffic rate is monitored and metered to verify conformity with an established contract. Non-conforming traffic is discarded, while conforming traffic passes through the interface without any changes. The EtherXtend 3400 follows RFC 2697 for rate limiting on both the ingress and egress of the interface.

The two modes of rate limiting are:

- Color blind

Rate limiting is performed on the interface without using the frame's Class of Service (CoS) by assuming that all packets of a flow are “uncolored” and are treated equally.

Color blind mode is most commonly used for a single service per VLAN.

- Color aware

Rate limiting observes that the incoming packet flow is colored and each packet is marked green, yellow, or red to signify if a packet has high, medium, or low priority. The color field maps to the priority CoS value in tagged packets and the IP precedence TOS value in untagged packets.

Color aware mode is most commonly used for multiple services on a single VLAN to ensure that the higher priority packets get through if there is bandwidth contention.



**Note:** Color values are not supported on egress ports.

### Color blind rate limiting

Color blind rate limiting is usually set when one service is supplied per VLAN. The rate limit, Committed Information Rate (CIR), is set in bytes per second. For any rate above the set CIR, packets will drop.

For example, in Figure 16, you would use the color blind method to set VLAN 100 to drop packets when the rate exceeds 5 Mbps, VLAN 200 to drop packets when the rate exceeds 3 Mbps, and VLAN 200 to drop packets when the rate exceeds 6 Mbps.

**Figure 16: One service per VLAN on an interface**

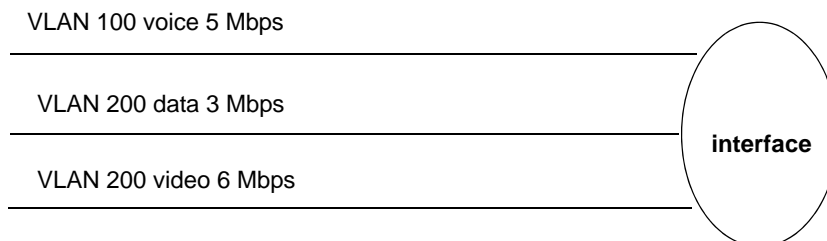

## Configure color blind policing

The **rule add ratelimitdiscard** command sets the rate above which packets will be dropped.



**Note:** The default values for CBS and EBS are good for most situations. Only advanced users should change these values.

```
rule add ratelimitdiscard <groupIndex/memberIndex> rate <rate> [cbs <value>] [ebs <value>]
```

For example, rule add ratelimitdiscard 4/1 rate 1300000

```
zSH> rule add ratelimitdiscard 4/1 rate 1300000
Created packet-rule-record 4/1 (ratelimitdiscard)
```

To view all created rules enter:

```
zSH> rule show
Group/Member                                Type Value(s)
-----
      1/2                                bridgeinsertpppoevendortag
      1/3                                bridgeinsertoption82
      4/1                                ratelimitdiscard 1300000 400000 400000
3 record(s) found
```

To view just the **ratelimitdiscard** rules enter:

(value1 is CIR, value2 is CBS, value3 is EBS)

```
zSH> rule show ratelimitdiscard
Group/Member                                Type Value(s)
-----
      4/1                                ratelimitdiscard 1300000 400000 400000
1 record(s) found
```

## Color aware rate limiting



**Note:** Not commonly used except when performing advanced configurations.

Color aware bandwidth limiting is usually used when multiple services with different priorities are offered on a single VLAN. The colors green, yellow, and red are used for metering traffic and the colors correspond to CoS values that range from 0-7. You can set which colors correspond to which CoS value.

Color Aware Policing is based on the idea that upstream devices are policing and marking frames based on a set of rules. A green packet is well behaved. A yellow packet has misbehaved at some point so if there is a bandwidth congestion it should be dropped before a green frame. A red packet has violated a rule and should be dropped. This means that green packets are serviced first, then if there is enough room, the yellow packets are serviced. Red packets are always dropped.

[Table 22](#) shows the default mapping of CoS value to color.

**Table 22: Default Color to CoS/TOS values**

CoS value	Color
7	green
6	green
5	green
4	green
3	yellow
2	yellow
1	yellow
0	yellow

### Configure color aware policing

The **rule add colorawareratelimitdiscard** command sets the color priority and the rate above which packets will be dropped.

```
rule add colorawareratelimitdiscard <groupIndex/memberIndex> rate <rate> [cbs <value>]
[ebs <value>] [hi-priority <value>] [low-priority <value>]
```

For example, rule add colorawareratelimitdiscard 5/1 rate 1300000

```
zSH> rule add colorawareratelimitdiscard 5/1 rate 1300000
Created packet-rule-record 5/1 (colorawareratelimitdiscard
```

Value1 is CIR, value2 is CBS, value3 is EBS, value4 is hi-priority, value5 is low-priority.

To view just the **colorawareratelimitdiscard** rules just created enter:

```
zSH> rule show colorawareratelimitdiscard
Group/Member                                Type Value(s)
-----
          5/1                                colorawareratelimitdiscard 1300000 400000 400000 4 0
1 record(s) found
```

## Verifying bridge settings

To verify bridge settings, enter **get bridge-interface-record** for each bridge. This command displays the bridge settings, including the **learnMulticast** and **forwardToMulticast**.

For the uplink bridge, note that the **forwardToMulticast** setting is *true* the **learnMulticast** setting is *false*.

```
zSH> get bridge-interface-record 1-1-201-0-efmbond/bridge
vpi: -----> {0}
vci: -----> {0}
vlanId: -----> {0}
stripAndInsert: -----> {false}
customARP: -----> {true}
filterBroadcast: -----> {true}
learnIp: -----> {false}
learnUnicast: -----> {false}
maxUnicast: -----> {0}
learnMulticast: -----> {false}
forwardToUnicast: -----> {true}
forwardToMulticast: -----> {true}
forwardToDefault: -----> {false}
bridgeIfCustomDHCP: -----> {true}
bridgeIfConfigGroupIndex: -> {0}
vlanIdCOS: -----> {0}
outgoingCOSOption: -----> {disable}
outgoingCOSValue: -----> {0}
s-tagTPID: -----> {0x8100}
s-tagId: -----> {0}
s-tagStripAndInsert: -----> {false}
s-tagOutgoingCOSOption: ----> {s-tagdisable}
s-tagIdCOS: -----> {0}
s-tagOutgoingCOSValue: ----> {0}
```

For the downlink bridge, note that the **forwardToMulticast** setting is false and the **learnMulticast** setting is true.

```
zSH> get bridge-interface-record 1-1-3-0-eth/bridge
bridge-interface-record 1-1-3-0-eth/bridge
vpi: -----> {0}
vci: -----> {0}
```

```

vlanId: -----> {800}
stripAndInsert: -----> {true}
customARP: -----> {false}
filterBroadcast: -----> {false}
learnIp: -----> {true}
learnUnicast: -----> {true}
maxUnicast: -----> {5}
learnMulticast: -----> {true}
forwardToUnicast: -----> {false}
forwardToMulticast: -----> {false}
forwardToDefault: -----> {true}
bridgeIfCustomDHCP: -----> {false}
bridgeIfIngressPacketRuleGroupIndex: -> {0}
vlanIdCOS: -----> {0}
outgoingCOSOption: -----> {disable}
outgoingCOSValue: -----> {0}
s-tagTPID: -----> {0x8100}
s-tagId: -----> {0}
s-tagStripAndInsert: -----> {true}
s-tagOutgoingCOSOption: -----> {s-tagdisable}
s-tagIdCOS: -----> {0}
s-tagOutgoingCOSValue: -----> {0}
mcastControlList: -----> {2}
maxVideoStreams: -----> {1}
isPPPoA: -----> {false}
floodUnknown: -----> {false}
floodMulticast: -----> {false}
bridgeIfEgressPacketRuleGroupIndex: --> {0}
bridgeIfTableBasedFilter: -----> {NONE(0)}
bridgeIfDhcpLearn: -----> {NONE(0)}

```

In addition, you can run the **bridge igmp** command to determine whether IGMP is running on the system.

```

zSH> bridge igmp

```

VlanID	MAC Address	MCAST IP	Ifndx	Host MAC	Last Join
999	01:00:5e:02:7f:fe	224.2.127.254	921	00:02:02:0b:4a:a0	2
999	01:00:5e:02:7f:fe	224.2.127.254	922	00:02:02:0a:bb:6d	106
999	01:00:5e:02:7f:fe	224.2.127.254	923	00:02:02:0a:c0:b7	87
999	01:00:5e:02:7f:fe	224.2.127.254	924	00:02:02:0b:4e:c5	172
999	01:00:5e:02:7f:fe	224.2.127.254	925	00:02:02:0b:4c:7e	65
999	01:00:5e:02:7f:fe	224.2.127.254	926	00:02:02:0b:4f:08	46
999	01:00:5e:02:7f:fe	224.2.127.254	927	00:02:02:09:c1:7d	90
999	01:00:5e:02:7f:fe	224.2.127.254	928	00:02:02:0b:44:cd	71
999	01:00:5e:02:7f:fe	224.2.127.254	929	00:02:02:0b:4c:ca	61
999	01:00:5e:02:7f:fe	224.2.127.254	930	00:02:02:0b:47:bd	7
999	01:00:5e:02:7f:fe	224.2.127.254	931	00:02:02:0b:47:c7	177
999	01:00:5e:02:7f:fe	224.2.127.254	932	00:02:02:0b:4d:35	181
999	01:00:5e:02:7f:fe	224.2.127.254	933	00:02:02:0b:4d:5b	144
999	01:00:5e:02:7f:fe	224.2.127.254	934	00:02:02:0b:4a:a5	59
999	01:00:5e:02:7f:fe	224.2.127.254	935	00:02:02:0b:4c:9e	3
999	01:00:5e:02:7f:fe	224.2.127.254	936	00:02:02:09:c1:78	6
999	01:00:5e:02:7f:fe	224.2.127.254	937	00:02:02:0a:c0:ca	131

## EtherXtend 3400 CO and CPE mode bridge scenarios

EtherXtend 3400s can be configured in either CO mode or CPE mode with either Transparent LAN Services (TLS) or uplink/downlink bridges. To enable bridged interfaces on the EtherXtend 3400, different bridge types can be configured on the device depending on the mode of operation.

- [Bridges on EtherXtend 3400 CPE mode on page 112](#)
- [Configure the EtherXtend 3400 in CO mode on page 115](#)

### Bridges on EtherXtend 3400 CPE mode

When the EtherXtend 3400 is configured in CPE mode, the WAN traffic connects to a MALC EFM card through a bonded connection and the LAN traffic connects to subscribers. In this mode, the EtherXtend 3400 WAN and LAN interfaces can use either TLS bridging or uplink/downlink bridging.

### Configure TLS bridges

TLS bridges learn MAC addresses and forward packets to learned destinations. Broadcasts and unknown unicasts are flooded out all interfaces except the ingress interface. Packets entering the system on TLS interface have their source MAC addresses learned and associated with the interface so that frames from the network that come in on other TLS bridges in the VLAN can be sent to the correct interface. A TLS bridge is used with only other TLS bridges. This should not be used with any asymmetrical bridges. TLS bridges must be configured on both the WAN and the LAN ports on the EtherXtend 3400 as shown in [Figure 17](#).

Figure 17: EtherXtend 3400 CPE mode with TLS bridges

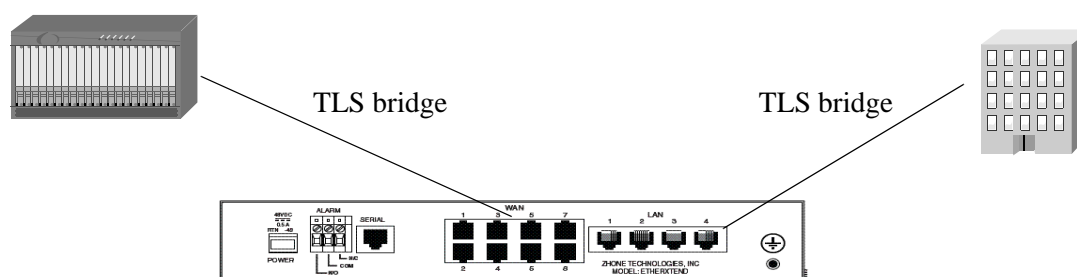

### Creating the TLS bridge on the EtherXtend 3400

- 1 To find the interface associated with the default bond group configured on the WAN ports, enter **interface show**.

```
zSH> interface show
1 interface
```



Interface	Status	Rd/Address	Media/Dest Address	IfName
1/1/40/0/ip	UP	1 10.250.1.40/24	00:01:47:36:2e:7b	1-1-40-0-efmbond-7

The active default EFM interface *1-1-40-0-efmbond-7* is shown.

To display the default bond group, enter **bond show all**:

```
zSH> bond show all
```

Bond Groups				
Slot	GrpId	Name	Type	State
1	40	1-1-40-0	efmbond	ACT

- 2 To create a TLS bridge on the WAN interface using the default bond group interface, enter **bridge add interface/type tls**. In this example, the default interface is *1-1-40-0/efmbond* with a VLAN ID of 7.

```
zSH> bridge add 1-1-40-0/efm tls vlan 7
```

```
Adding bridge on 1-1-40-0/efmbond
```

```
Created bridge-interface-record 1-1-40-0-efmbond/bridge
```

- 3 Next, create a TLS bridge on the LAN interface with **bridge add interface/type tls**. This example configures a TLS bridge on the first Ethernet LAN interface *1-1-1-0-eth* with a VLAN ID of 200.

```
zSH> bridge add 1-1-1-0/eth tls vlan 200
```

```
Adding bridge on 1-1-1-0/eth
```

```
Created bridge-interface-record 1-1-1-0-eth/bridge
```

- 4 To verify the bridges created, enter **bridge show**:

```
zSH> bridge show
```

Typ	VLAN	Bridge	St	Table	Data
tls	200	1-1-1-0-eth/bridge	DWN		
tls	7	1-1-40-0-efmbond/bridge	UP		

## Configure uplink and downlink bridges

An uplink bridge uses one bridge interface in a VLAN as a default, and traffic from all other interfaces exits the system from this interface. As the default interface, packets entering the system on this interface do not have their source MAC addresses learned and associated with this interface. Traffic coming into this uplink interface is sent to the interface where the address has been learned.

Uplink bridge interfaces require an additional bridge-path configuration to set a default path for either a specific VLAN or globally for the system onto the uplink bridge. If an uplink is missing this configuration, traffic will not flow across the asymmetric VLAN.

A downlink bridge is used in conjunction with an uplink bridge, where the uplink bridge is the path upstream to the network, and the downlink bridge is the learning interface facing subscribers. Traffic coming into this interface is forwarded to the uplink regardless of the destination MAC address. Broadcasts and unicasts (known and unknown) will be sent out the default interface, which is the uplink bridge for the VLAN.

Packets entering the system on this interface have their source MAC addresses learned and associated with this interface. Because this interface is not a default, it is required to learn MAC addresses, so that frames from the network that come in on the uplink bridge can be sent to the correct downlink bridge.

Configure the EtherXtend 3400 with uplink and downlink bridges when the uplink bridge is the path upstream to the network, and the downlink bridge is the learning interface facing subscribers as shown in [Figure 18](#).

**Figure 18: EtherXtend 3400 in CPE mode with uplink and downlink bridges**

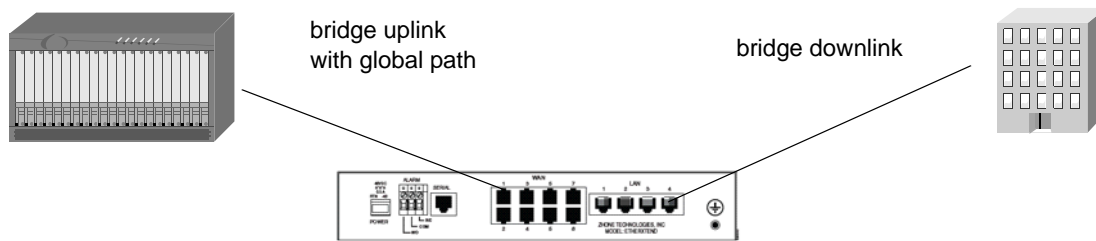

### Creating uplink and downlink bridges on the EtherXtend 3400

- 1 To find the interface associated with the default bond group configured on the WAN ports, enter **interface show**. This examples shows the active default EFM interface *1-1-40-0-efmbond-7*.

```
zSH> interface show
1 interface
Interface      Status  Rd/Address          Media/Dest Address  IfName
-----
1/1/40/0/ip    UP      1 10.250.1.40/24    00:01:47:36:2e:7b  1-1-40-0-efmbond-7
-----
```

To display the default bond group, enter **bond show all**:

```
zSH> bond show all
Bond Groups
Slot  GrpId  Name      Type      State
---  ---  ---
1     40     1-1-40-0  efmbond  ACT
```

- To configure an uplink bridge on the WAN interface enter, **bridge add interface/type uplink** using the interface of the bond group.

```
zSH> bridge add 1-1-40-0/efmbond uplink
Adding bridge on 1-1-40-0/efmbond
Created bridge-interface-record 1-1-40-0-efmbond-0/bridge
```

To create a bridge path for the uplink enter, **bridge-path add interface/type global**:

```
zSH> bridge-path add 1-1-40-0-efmbond-0/bridge global
Bridge-path added successfully
```

- To create a downlink bridge on the LAN interface, enter **bridge add interface/type downlink VLAN 100**:

```
zSH> bridge add 1-1-1-0/eth downlink vlan 100
Adding bridge on 1-1-1-0/eth
Created bridge-interface-record 1-1-1-0-eth/bridge
```

- To verify the bridges created, enter **bridge show**:

```
zSH> bridge show
```

Typ	VLAN	Bridge	St	Table	Data
dwn	123	1-1-4-0-eth/bridge	UP	D	00:13:72:de:92:2e D 00:1a:6d:13:19:8f S VLAN 123 default [U: 3600 sec, M: 150 sec, I: 0 sec]
upl	Tagged	1-1-40-0-efmbond-0/bridge	UP	S	Global default [U: 3600 sec, M: 150 sec, I: 0 sec]
dwn	100	1-1-1-0-eth/bridge	DWN		

## EtherXtend 3400 CO mode with subtended EtherXtend 3400s in CPE mode

EtherXtend 3400 configurations can bridge together devices in both CO mode and CPE mode.

### Configure the EtherXtend 3400 in CO mode

The EtherXtend 3400 can be configured in CO mode which uses an uplink bridge to the outside network and a downlink bridges to subtended EtherXtend 3400s in CPE mode.

Figure 19 shows one EtherXtend 3400 device in CO mode and two EtherXtend 3400 devices configured in CPE mode. The EtherXtend 3400 CPE 1 uses a TLS bridge with VLAN 100 to connect the WAN to the LAN. The EtherXtend 3400 CPE 2 also uses a TLS bridge with VLAN 200 to connect the WAN to the LAN.

Figure 19: EtherXtend 3400 CO scenario

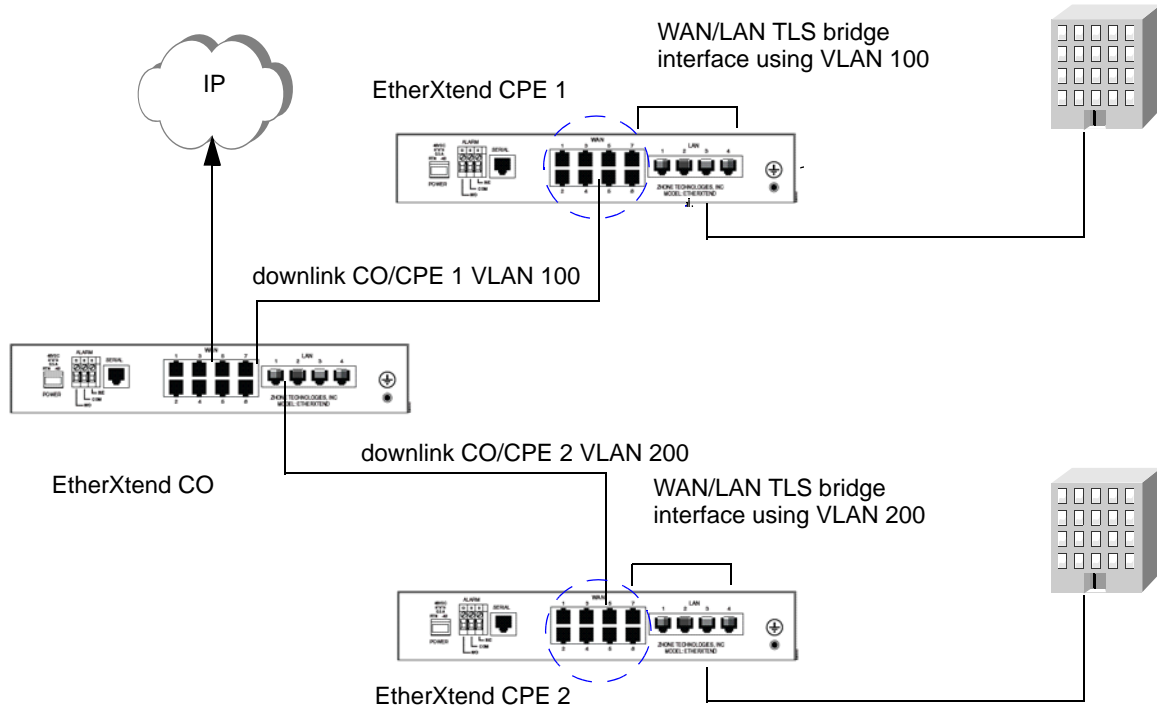

### Configure the EtherXtend 3400 in CO mode

On EtherXtend 3400 in CO mode, create an uplink bridge on a WAN Ethernet port to connect to the external network and create two downlink bridges on the WAN ports that connect to the two subtended EtherXtend 3400s in CPE mode. In this example, the downlinks use VLAN 100 and VLAN 200. Then create TLS bridges from the WANs to the LANs.



**Note:** This procedure assumes that a device in the network is connected to the EtherXtend 3400 in CO mode.

- 1 Display the default bond group, enter **bond show all**:

```
zSH> bond show all
```

```

Bond Groups
Slot  GrpId  Name           Type           State
1     99       1-1-99-0      efmbond        ACT

```

- 2 To configure an uplink bridge on the WAN interface enter, **bridge add interface/type uplink** using the interface of the bond group.

```
zSH> bridge add 1-1-40-0/efmbond uplink
```

```
Adding bridge on 1-1-40-0/efmbond
```

```
Created bridge-interface-record 1-1-40-0-efmbond-0/bridge
```

To create a bridge path for the uplink enter:

```
zSH> bridge-path add 1-1-40-efmbond-0/bridge global
Bridge-path added successfully
```

- 3 To create the downlink bridge on the WAN port for CPE 1 using VLAN 100, enter **bridge add interface/type downlink vlan 100**:

```
zSH> bridge add 1-1-40-0/efmbond downlink vlan 100
```

All bridge traffic will be forwarded to the EtherXtend 3400 CPE 1 on VLAN 100.

- 4 To create the downlink bridge for CPE 2 with VLAN 200 on the WAN port, enter **bridge add interface/type downlink vlan 200**:

```
zSH> bridge add 1-1-40-0/efmbond downlink vlan 200
```

All bridge traffic will be forwarded to the EtherXtend 3400 CPE 2 on VLAN 200.

## Configure the EtherXtend 3400 in CPE mode

The subtended EtherXtend 3400s in CPE mode are configured with TLS bridges to direct traffic to the subscriber.

### Creating TLS bridges on the EtherXtend 3400 CPE 1

When using TLS bridges on a device, both the WAN port and the LAN port must use TLS bridges.

- 1 To find the bond group number on the WAN, enter the **bond show all**:

```
zSH> bond show all
```

Bond Groups				
Slot	GrpId	Name	Type	State
1	40	1-1-40-0	efmbond	ACT

- 2 To create a TLS bridge interface on the WAN port using the bond group number, enter **bridge add interface/type tls**:

```
zSH> bridge add 1-1-40-0-efmbond-0/bridge tls
```

- 3 To create a TLS bridge interface on the LAN port to the business, enter **bridge add interface/type tls**:

```
zSH> bridge add 1-1-1-0-eth/bridge tls
```

- 4 To verify the bridges created, enter **bridge show**:

```
fml> bridge show
```

Typ	VLAN	Bridge	St	Table	Data
tls		0 1-1-1-0-eth/bridge	UP		
tls		0 1-1-40-0-efmbond/bridge	UP		

## Creating TLS bridges on the EtherXtend 3400 CPE 2

When using TLS bridges on a device, both the WAN port and the LAN port must use TLS bridges.

- 1 To find the bond group number on the WAN, enter the **bond show all**:

```
zSH> bond show all
```

Bond Groups				
Slot	GrpId	Name	Type	State
1	40	1-1-40-0	efmbond	ACT

- 2 To create a TLS bridge interface on the WAN port using the bond group number, enter **bridge add interface/type tls**:

```
zSH> bridge add 1-1-40-0-efmbond-0/bridge tls
```

- 3 To create a TLS bridge interface on the LAN port to the business, enter **bridge add interface/type tls**:

```
zSH> bridge add 1-1-1-0-eth/bridge tls
```

- 4 To verify the bridges created, enter **bridge show**:

```
fm1> bridge show
```

Typ	VLAN	Bridge	St	Table	Data
tls		0 1-1-1-0-eth/bridge	UP		
tls		0 1-1-40-0-efmbond/bridge	UP		

## EtherXtend 3400 bridge commands

The EtherXtend 3400 supports the following **bridge** commands:

- [Bridge delete command on page 118](#)
- [Bridge show command on page 119](#)
- [Bridge stats on page 119](#)

Refer to the *Zhone CLI Reference Guide* for a detailed explanation of the available **bridge** commands.

### Bridge delete command

The **bridge delete** command deletes a specific bridge entry from the system.

```
zSH> bridge delete 1-1-40-0-efm-0/bridge
1-1-40-0-efmbond-0/bridge Delete complete
```

## Bridge show command

The **bridge show** command displays either a single bridge path entry or the entire bridge table.

```
zSH> bridge show
Typ VLAN          Bridge                               St  Table Data
-----
dwn              123 1-1-4-0-eth/bridge                UP  D 00:1a:6d:13:19:8f
                                     S VLAN 123 default [U: 3600 sec, M: 150
sec, I: 0 sec]
                0 1-1-3-0-eth/bridge                    DWN
Tagged           1-1-1-0-eth-0/bridge                  DWN
Tagged 4000     1-1-1-0-eth-4000/bridge               DWN
Tg 1000/17      1-1-1-0-eth-1000/bridge               DWN
                50 1-1-2-0-eth/bridge                    DWN
                100 1-1-40-0-efmbond/bridge               UP
```

## Bridge stats

The **bridge stats** command displays and clear bridge interface statistics for all bridges, bridges associated with a specified VLAN ID, and a specified bridge interface.

```
zSH> bridge stats
Interface
Name
1-1-4-0-eth      Received Packets      Transmitted Packets
UCast  MCast  BCast  UCast  MCast  Bcast  Error
11920K 318K  197    6883K  0      0      0
1-1-3-0-eth      0      0      0      0      0      0      0
1-1-1-0-eth-0    0      0      0      0      0      0      0
1-1-1-0-eth-4000 0      0      0      0      0      0      0
1-1-1-0-eth-1000 0      0      0      0      0      0      0
1-1-2-0-eth      0      0      0      0      0      0      0
1-1-40-0-efmbond 0      0      0      0      0      0      0

zSH> bridge stats vlan 4000
Interface
Name
1-1-1-0-eth-4000 Received Packets      Transmitted Packets
UCast  MCast  BCast  UCast  MCast  Bcast  Error
0      0      0      0      0      0      0
```





# 9

## ETHERXTEND 3400 ADVANCED CONFIGURATION

This chapter covers EtherXtend 3400 advanced configuration:

- [View EtherXtend 3400 statistics, page 121](#)
- [EtherXtend 3400 bond group statistics, page 123](#)
- [Display EFM profile parameters, page 127](#)
- [Perform EFM updates, page 128](#)
- [Modify EFM port interfaces, page 129](#)
- [802.3ah EFM OAM, page 130](#)

### View EtherXtend 3400 statistics

[Table 23](#) provides a list of commands to provide statistics related to the EtherXtend 3400.

**Table 23: Statistics commands**

Command	Description
show efm-stats	Displays EFM statistics.
eth-oam stats	Displays OAM statistics.
show pme-stats	Displays PME statistics.

```
zSH> show efm-stats
efmCuPAFSupported:-----> true false
efmCuPeerPAFSupported:----> unknown true false
efmCuPAFCapacity:-----> {1 - 32}
efmCuPeerPAFCapacity:----> {0 - 32}
efmCuFltStatus:-----> {0 - 0}
efmCuPortSide:-----> subscriber office unknown
efmCuNumPMEs:-----> {0 - 32}
efmCuPAFInErrors:-----> {0 - 0}
efmCuPAFInSmallFragments:-> {0 - 0}
efmCuPAFInLargeFragments:-> {0 - 0}
efmCuPAFInBadFragments:---> {0 - 0}
efmCuPAFInLostFragments:--> {0 - 0}
efmCuPAFInLostStarts:-----> {0 - 0}
efmCuPAFInLostEnds:-----> {0 - 0}
```

```
efmCuPAFInOverflows:-----> {0 - 0}
```

```
zSH> eth-oam stats
```

```
***** dot3OamStatsTable for interface 1-1-201-0/efmbond *****
```

Information Tx	4
Information Rx	4
UniqueEventNotification Tx	0
UniqueEventNotification Rx	0
DuplicateEventNotification Tx	0
DuplicateEventNotification Rx	0
LoopbackControl Tx	0
LoopbackControl Rx	0
VariableRequest Tx	0
VariableRequest Rx	0
VariableResponse Tx	0
VariableResponse Rx	0
OrgSpecific Tx	0
OrgSpecific Rx	0
UnsupportedCodes Tx	0
UnsupportedCodes Rx	0
FramesLostDueToOam	0

```
zSH> show pme-stats
```

```
efmCuPmeSubTypesSupported:-> {0 - 0}  
efmCuPmeOperStatus:-----> up downnotready downready init  
efmCuPmeFltStatus:-----> {0 - 0}  
efmCuPmeOperSubType:-----> ieee2basetlo ieee2basetlr ieee10passtso  
ieee10passtsr  
efmCuPmeOperProfile:-----> {0 - 255}  
efmCuPmeSnrMgn:-----> {-127 - 65535}  
efmCuPmePeerSnrMgn:-----> {-127 - 65535}  
efmCuPmeLineAtn:-----> {-127 - 65535}  
efmCuPmePeerLineAtn:-----> {-127 - 65535}  
efmCuPmeTCCodingErrors:-----> {0 - 0}  
efmCuPmeTCCrcErrors:-----> {0 - 0}
```

## EtherXtend 3400 bond group statistics

This section describes how to view EtherXtend 3400 bond group statistics and set alarm thresholds:

- [View bond group statistics, page 123](#)
- [View alarm activity, page 124](#)
- [View individual member of bond group statistics, page 125](#)
- [Set alarm thresholds, page 126](#)

### View bond group statistics

The EtherXtend 3400 and other bonding capable devices provide the **bond stats interface/type** command to display both the status of the bond group and the status of each individual link in the bond group and to provide statistics for the bond group. A bond group is the aggregate of individual links on a device connected to the same CPE that provides a higher bandwidth than individual links can provide.

To view the statistics for an EtherXtend 3400 bond group enter **bond stats interface/type**:

```
zSH> bond stats 1-1-99-0/efmbond
***** Bond group statistics *****
          Group Info
Slot      GrpId      Interface Name
  1         99      1-1-99-0/efmbond
AdminStatus      OperStatus      Bandwidth      Last Change
  UP              UP              45568000      0.00:06:09
Threshold Alarm Config
  disabled
          Group Members
Port      Interface Name      AdminStatus      OperStatus      Bandwidth
  3        1-1-3-0/shdsl        UP              UP              5696000
  2        1-1-2-0/shdsl        UP              UP              5696000
  1        1-1-1-0/shdsl        UP              UP              5696000
  8        1-1-8-0/shdsl        UP              UP              5696000
  7        1-1-7-0/shdsl        UP              UP              5696000
  6        1-1-6-0/shdsl        UP              UP              5696000
  5        1-1-5-0/shdsl        UP              UP              5696000
  4        1-1-4-0/shdsl        UP              UP              5696000
          Statistics (Received)
Octets              480675689
Ucast              219070183
Mcast              0
Bcast              96
Discards           0
Errors             8649
          Statistics (Transmitted)
Octets             1370350049
Ucast             220924681
```

```
Mcast          129866
Bcast          58
Discards       0
```

Check the output of the Bandwidth column in the Group Info section to view the aggregate train rate of the bond group. This aggregate rate can change depending on the status of the individual links in the bond group as shown in the Group members section.

In the example below, 1-1-6-0/shdsl went down dropping the bandwidth to 0 dropping the bandwidth of the bond group interface 1-1-99-0/shdsl.

```
SH> bond stats 1-1-99-0/efmbond
***** Bond group statistics *****
          Group Info
Slot      GrpId      Interface Name
  1         99      1-1-99-0/efmbond
AdminStatus OperStatus      Bandwidth      Last Change
  UP          UP          39872000      0.00:09:36
Threshold Alarm Config
disabled
          Group Members
Port      Interface Name  AdminStatus      OperStatus      Bandwidth
  3        1-1-3-0/shdsl    UP                UP                5696000
  2        1-1-2-0/shdsl    UP                UP                5696000
  1        1-1-1-0/shdsl    UP                UP                5696000
  8        1-1-8-0/shdsl    UP                UP                5696000
  7        1-1-7-0/shdsl    UP                UP                5696000
  6        1-1-6-0/shdsl    UP                DOWN              0
  5        1-1-5-0/shdsl    UP                UP                5696000
  4        1-1-4-0/shdsl    UP                UP                5696000
          Statistics (Received)
Octets          480675689
Ucast          219070183
Mcast          0
Bcast          96
Discards       0
Errors         8649
          Statistics (Transmitted)
Octets         1370394534
Ucast         220924681
Mcast         130519
Bcast         58
Discards       0
```

## View alarm activity

To view alarm activity enter **alarm show**:

```
zSH> alarm show
***** Central Alarm Manager *****
ActiveAlarmCurrentCount : 3
AlarmTotalCount         : 9
```

```

ClearAlarmTotalCount          :6
OverflowAlarmTableCount       :0
ResourceId                    AlarmType                    AlarmSeverity
-----
1-1-2-0/eth                   linkDown            critical
1-1-3-0/eth                   linkDown            critical

1-1-99-0/efmbond              threshold_alarm_active  minor

```

The output shows a minor alarm on the 1-1-99-0/efmbond interface.

This change may be important when a loss of the aggregate rate affects service. In that case you can set a parameter in the EtherXtend 3400's **alarm-config** profile to send a trap when the rate drops below a certain level.

See [Set alarm thresholds on page 126](#).

## View individual member of bond group statistics

If you need to view the statistics of an individual member of a bond group, enter **dslstat interface/type**:

```

zSH> dslstat 1-4-1-0/shdsl
General Stats:
-----
AdminStatus.....UP
LineStatus.....DATA
Line uptime (DD:HH:MM:SS).....0:04:35:14
DslUpLineRate (bitsPerSec).....5696000
DslDownLineRate (bitsPerSec).....5696000
DslMaxAttainableUpLineRate (bitsPerSec).....5696000
DslMaxAttainableDownLineRate (bitsPerSec)....5696000
Out Octets.....4104990247
Out Pkts/Cells.....127962354
Out Discards.....0
Out Errors.....0
In Octets.....1189520311
In Pkts/Cells.....215674806
In Discards.....0
In Errors.....5104364
DSL Physical Stats:
-----
DslLineSnrMgn (tenths dB).....180
DslLineAtn (tenths dB).....0
DslCurrOutputPwr (tenths dB).....0
LOFS.....0
LOLS.....4294967295
LOSS.....4294967295
ESS.....46450
CRC Errors.....8
Inits.....153
zSH>

```

## Set alarm thresholds

Bonding capable devices provide an **alarm-config** profile to enable traps and alarms to be sent after meeting certain criteria. You can monitor the bond group bandwidth and have traps and alarms sent whenever the bandwidth drops below a particular threshold for a particular holdtime.

Enter **get alarm-config interface/type** to view the **alarm-config** profile:

```
zSH> get alarm-config 1-1-99-0/efmbond
alarm-config 1-1-99-0/efmbond
bit-rate-threshold: -----> {disabled}:
bit-rate-threshold-value: ----> {0}:
bit-rate-threshold-holdtime: -> {0}:
status-trap-enable: -----> {enabled}:
admin-up-alarm: -----> {disabled}:
```

Table 24 describes the **alarm-config** profile parameters.

**Table 24: EtherXtend 3400 alarm-group profile**

Parameter	Function
bit-rate threshold	Enabled turns this feature on. Disabled turns this feature off.
bit-rate-threshold-value	The bandwidth of the bond group rate, set in Kbps, that generates a trap and alarm when the rate drops below this level.
bit-rate-threshold-holdtime	The time that the bandwidth must remain above or below the bit-rate-threshold-value before a trap is sent and an alarm is set or cleared. The purpose of this parameter is to keep down jitter.
status-trap-enable	Enabled turns the feature on to send a trap indicating the status of the interface. Disabled turns the feature off. Default is enabled. For ZMS.
admin-up-alarm	For MALC.

You can set the threshold alarm by first enabling the **bit-rate-threshold** parameter, then entering a bit-rate value in Kbps in the **bit-rate-threshold-value** parameter field for the bond group.

The **status-trap-enable** parameter defaults to enabled. Enter **update alarm-config interface/type** as follows:

```
zSH> update alarm-config 1-1-99-0/efmbond
alarm-config 1-1-99-0/efmbond
Please provide the following: [quit].
bit-rate-threshold: -----> {disabled}: enabled
bit-rate-threshold-value: ----> {0}: 45000
```

```

bit-rate-threshold-holdtime: -> {0}:
status-trap-enable: -----> {enabled}:
admin-up-alarm: -----> {disabled}:
.....
Save changes? [s]ave, [c]hange or [q]uit: s Record updated.

```

If the aggregate bandwidth of the links in the bond group drops below the `bit-rate-threshold-value` set in the `alarm-config` and remains below this value for the `bit-rate-threshold-holdtime` set in the **alarm-config** profile, then a trap and an alarm will be sent.

## Display EFM profile parameters

EFM supports three commands to display output for valid parameters affected by EFM. The commands are:

- **show efm-bond**
- **show efm-port**
- **show ether-oam**

## Display EFM information

To display EFM parameter information, enter **show efm-bond** and **show efm-port**:

```

zSH> show efm-bond
config:-----> auto manual
dynamic-link:-> enabled disabled

zSH> show efm-port
efmCuPAFAdminState:-----> enabled disabled
efmCuPAFDiscoveryCode:-----> {260}
efmCuAdminProfile:-----> {8}
efmCuTargetDataRate:-----> {1 - 999999}
efmCuTargetWorstCaseSnrMgn:-----> {-10 - 21}
efmCuThreshLowBandwidth:-----> {0 - 100000}
efmCuLowBandwidthEnable:-----> true false
efmCuTargetCurrentConditionMode:----> true false
efmCuTargetCurrentConditionSnrMgn:-> {-10 - 21}
efmCuTargetWorstCaseMode:-----> true false

```

To display OAM event configuration, enter **show ether-oam**:

```

zSH> show ether-oam
mode:-----> passive active
loopbackStatus:-----> noloopback
initiatingloopback remoteloopback terminatingloopback 1

```

```

ocalloopback unknown
ignoreLoopbackCommands:-----> ignore process
symbolPeriodSizeHi:-----> {0 - 0}
symbolPeriodSizeLo:-----> {0 - 0}
symbolPeriodErrorThresholdHi:-----> {0 - 0}
symbolPeriodErrorThresholdLo:-----> {0 - 0}
symbolPeriodErrorNotifyEnable:-----> true false
framePeriodSize:-----> {0 - 0}
framePeriodErrorThreshold:-----> {0 - 0}
framePeriodErrorNotifyEnable:-----> true false
intervalWindowSize:-----> {0 - 0}
intervalFrameErrorThreshold:-----> {0 - 0}
intervalFrameErrorNotifyEnable:----> true false
intervalErrorSummaryWindow:-----> {100 - 9000}
intervalErrorSummaryThreshold:-----> {1 - 900}
intervalErrorSummaryNotifyEnable:-> true false
dyingGaspEnable:-----> true false
criticalEventEnable:-----> true false

```

## Perform EFM updates

The **update** command updates an existing **efm-oam** profile for the unit.

### Update the EFM port profile

To update the EFM port profile using *1-1-1-1* as an example, enter **update efm-port**:

```

zSH> update efm-port 1-1-1-1
profileVersion: -----> {1.0}: ** read-only **
efmCuPAFAdminState: -----> {enabled}:
efmCuPAFDiscoveryCode: ----> {}:
efmCuAdminProfile: -----> {0x01}:
efmCuTargetDataRate: -----> {50000}:
efmCuTargetWorstCaseSnrMgn: -----> {6}:
efmCuThreshLowBandwidth: -> {0}:
efmCuLowBandwidthEnable: -> {false}:
efmCuThreshLowBandwidth: -> {0}
efmCuLowBandwidthEnable: -> {false}
efmCuTargetCurrentConditionMode: ----> {false}
efmCuTargetCurrentConditionSnrMgn: -> {6}
efmCuTargetWorstCaseMode: -----> {true}

```

The **efmCurrentConditionMode** parameter allows the line to sync using conditions that it *currently* sees on the line at the time of training and takes into consideration *only* the users/disbtubers (noise) seen at that particular moment in time. Because of this, it is recommended that you set this parameter to true only in lab situations or under other special scenarios that would not mind if the line becomes unstable or the link retrains. Instability



can occur because over time errors can increase causing retransmissions and lower throughput or cause a retrain of the link resulting in a lower traffic rate.

The `efmWorstCaseMode` allows the line to sync assuming line conditions are the worst they can be by assuming that there are forty nine users/disburbers even if they do not currently exist. Setting `efmWorstCaseMode` to true is the most stable setting because the line's SNR and stability are not effected when other users come onto the line. The line typically trains to a lower rate to allow for any SNR loss when these changes occur.

For n2n bonding, but *not* EFM bonding, you can set both the `efmCurrentConditionMode` and the `efmWorstCaseMode` to true. This results in a mixed mode that sets a more liberal train rate than `efmWorstCaseMode`, but a more conservative train rate than in `efmCurrentConditionMode`.

## Update the EFM bond

To update the **efm-bond** profile using 1 as an example, enter **update efm-bond**:

```
zSH> update efm-bond
dynamic link: -----> {enabled}
```

## Modify EFM port interfaces

### Perform a list command

EFM ports are automatically created. To view EFM port profiles, enter **list** to view what EFM profiles are available. The following example shows a list of EFM specific EFM profiles that are available.

```
zSH> list
efm-bond: ifIndex
efm-port: ifIndex
efm-stats: ifIndex
```

### EFM port default

To display the EFM port parameters in their default state enter **get efm-port interface/type**:

```
zSH> get efm-port 1-1-1-0/shdsl
efm-port 1-1-1-0/shdsl
efmCuPAFAdminState: -----> {enabled}
efmCuPAFDiscoveryCode: -----> {}
efmCuAdminProfile: -----> {0x01}
efmCuTargetDataRate: -----> {50000}
efmCuTargetWorstCaseSnrMgn: -----> {0}
efmCuThreshLowBandwidth: -----> {0}
efmCuLowBandwidthEnable: -----> {false}
```

```
efmCuTargetCurrentConditionMode: ---> {false}
efmCuTargetCurrentConditionSnrMgn: -> {6}
efmCuTargetWorstCaseMode: -----> {true}
```

## Modify an EFM port

To modify an EFM port, enter **update efm-port interface/type** to display the profile parameters.

```
zSH> update efm-port 1-1-1-0/shdsl
efm-port 1-1-1-0/shdsl
Please provide the following: [q]uit.
efmCuPAFAdminState: -----> {enabled}:
efmCuPAFDiscoveryCode: -----> {}:
efmCuAdminProfile: -----> {0x01}:
efmCuTargetDataRate: -----> {50000}:
efmCuTargetWorstCaseSnrMgn: -----> {1}:
efmCuThreshLowBandwidth: -----> {0}:
efmCuLowBandwidthEnable: -----> {false}:
efmCuTargetCurrentConditionMode: ---> {false}:
efmCuTargetCurrentConditionSnrMgn: -> {6}:
efmCuTargetWorstCaseMode: -----> {true}:
```

## Create a new EFM bond group

To create a new EFM bond group, use the **bond add** command:

```
zSH> bond add group 1-1-25-0/efmbond
zSH> bond add member 1-1-25-0/efmbond 1-1-1-0/shdsl
zSH> bond add member 1-1-25-0/efmbond 1-1-2-0/shdsl
```

## 802.3ah EFM OAM

EFM OAM uses an in-band link layer OAM packet exchange between MALC EFM interfaces and OAM capable CPEs such as the EtherXtend 3400. In this case the EtherXtend 3400 functions as a remote peer to provide discovery, OAM pdu statistics, and peer information.

When OAM is configured on a MALC EFM interface in active mode, the discovery process initiates a search for a peer OAM-enabled EtherXtend 3400 configured in passive mode and physically connected to the MALC EFM port of that interface. If the discovery process does not find an EtherXtend 3400 peer, the discovery process begins again after a five second pause and continues until a peer OAM-enabled EtherXtend 3400 is found.

Release 1.14.1 introduces OAM support on MALC-EFM-SHDSL-24, MALC-EFM-SHDSL-24NT, MALC-EFM-SHDSL-24NTP card interfaces connected to an EtherXtend 3400.

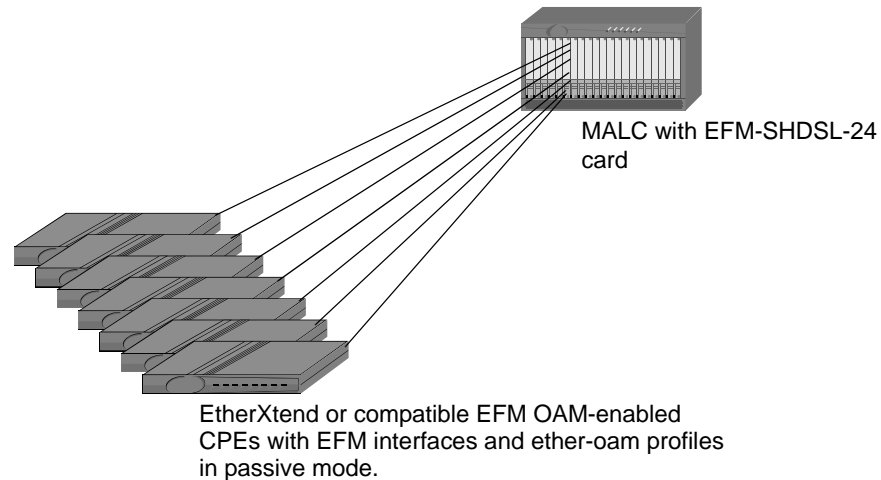

## OAM modes

EFM/CPEs incorporating the OAM sublayer support active and/or passive mode. When OAM is enabled, a EFM/CPE capable of both active and passive mode will select either active or passive. [Table 25](#) indicates the behavior of active and passive mode EFM/CPEs.

**Table 25: Active and passive mode**

Capability	Active EFM/CPE	Passive EFM/CPE
Initiates OAM discovery process.	Yes	No
Reacts to OAM discovery process initiation.	Yes	Yes
Required to send information OAMPDUs	Yes	Yes
Permitted to send event notification OAMPDUs	Yes	Yes
Permitted to send variable request OAMPDUs	Yes	No
Permitted to send variable response OAMPDUs	Yes	Yes
Permitted to send loopback control OAMPDUs	Yes	No

**Table 25: Active and passive mode (Continued)**

Capability	Active EFM/CPE	Passive EFM/CPE
Reacts to loopback control OAMPDUs	Yes	
Permitted to send organization specific OAMPDUs	Yes	Yes
Requires the per EFM/CPE to be in active mode	Yes	Yes

### Active mode

EFM/CPEs configured in active mode initiate the exchange of information OAMPDUs as defined by the discovery state. Once the discovery process completes, active EFM/CPEs are permitted to send any OAMPDU while connected to a remote OAM peer entity in active mode.

Active EFM/CPEs operate in a limited capacity if the remote OAM entity is operating in passive mode. Active devices should not respond to OAM remote loopback commands and variable requests from a passive peer.

### Passive mode

EFM/CPEs configured in passive mode do not initiate the discovery process. Passive EFM/CPEs react to the initiation of the discovery process by the remote EFM/CPE. This eliminates the possibility of passive to passive links.

## OAM commands

This sections describes commands used to add OAM functionality to a bridge interface, and commands to view information on that interface. The OAM commands are:

- **eth-oam add**
- **eth-oam stats**
- **eth-oam show**

### Add OAM to a bridge interface

Use **eth-oam add** to add OAM functionality to a bridge interface.

#### Adding OAM functionality to a bridge interface

- 1 To add OAM functionality to a EtherXtend 3400 bridge interface, enter **show bridge** to view the available interfaces:

```
zSH> bridge show
Typ VLAN          Bridge                               St Table Data
-----
upl Tagged        1-1-201-0-efmbond-0/bridge          UP S Global default [U: 3600 sec, M:
150 sec, I: 0 sec]
dwn                2 1-1-1-0-eth/bridge                UP
```

- 2 Enter the **eth-oam add** command to add OAM functionality to the bridge interface.

```
zSH> eth-oam add 1-1-201-0/efmbond
```

## Display OAM statistics

### Displaying eth-oam statistics

Enter **eth-oam stats** to display the OAM statistics associated with a bridge interface:

```
zSH> eth-oam stats
***** dot3OamStatsTable for interface 1-1-201-0/efmbond *****
Information Tx                4
Information Rx                4
UniqueEventNotification Tx    0
UniqueEventNotification Rx    0
DuplicateEventNotification Tx 0
DuplicateEventNotification Rx 0
LoopbackControl Tx           0
LoopbackControl Rx           0
VariableRequest Tx           0
VariableRequest Rx           0
VariableResponse Tx          0
VariableResponse Rx          0
OrgSpecific Tx                0
OrgSpecific Rx                0
UnsupportedCodes Tx           0
UnsupportedCodes Rx           0
FramesLostDueToOam           0
```

## Show the OAM profile

Enter **eth-oam show** to display the OAM profile.

```
zSH> eth-oam show
***** OAM Profile for interface 1-1-201-0/efmbond *****
OperationalState              Operational
OamMode                        passive
MaxOamPduSize                 1518
ConfigurationRevision          1
FunctionsSupported             None
OamLoopbackStatus              no Loopback
OamLoopbackIgnoreRx            ignore
```

ErroredFrame Window	10
ErroredFrame Threshold	1
ErroredFrame Notify	enabled
ErroredFramePeriod Window	4294967295
ErroredFramePeriod Threshold	1
ErroredFramePeriod Notify	disabled
ErroredFrameSecondsSummary Window	100
ErroredFrameSecondsSummary Threshold	1
ErroredFrameSecondsSummary Notify	disabled
DyingGaspEnable	disabled
CriticalEventEnable	disabled

## Configuring OAM support

The OAM interface is defined by an **ether-oam** profile that specifies the options for active/passive mode, loopback, and notification for events. By default, OAM is disabled on all MALC uplink and Ethernet interfaces.

To configure OAM features:

- 1 Create a new OAM profile for the desired Ethernet interface. By default, this profile is in passive mode with loopback disabled.

This example configures Ethernet OAM in active mode on EFM bond group *1-4-50-0/efmbond* on a EFM-SHDSL-24 card in slot 4.

```
zSH> eth-oam add 1-4-50-0/efmbond active
```

- 2 Create a new OAM profile for the desired EtherXtend 3400 interface. By default, this profile is in passive mode with loopback disabled.

This example configures Ethernet OAM in passive mode on EFM bond group *1-1-40-0/efmbond* on the peer EtherXtend 3400.

```
zSH> eth-oam add 1-1-4-40-0/efmbond passive
```

- 3 Enter commands to modify and display OAM parameters.

The **eth-oam modify** command provides access to configurable settings in the **ether-oam** profile.

The **eth-oam show** command displays configured OAM settings.

The **eth-oam stats** command displays OAM statistics for a specified physical interface or bond group or all OAM interfaces.

## eth-oam add

Configures and enables OAM interface on a physical interface.

**Syntax** `eth-oam interface/type [active | passive]`

**Options** `interface/type`

Name and type of the physical interface or bond group.

**active**

Sets OAM to *active* mode on this interface. The default is passive.

**passive**

Sets OAM to *passive* mode on this interface. The default is passive.

**eth-oam delete**

Deletes and disables the OAM configuration on the specified physical interface. This command does not delete any other configurations on this interface such as bond groups and bridge interfaces.

**Syntax** `eth-oam delete interface/type`

**Options** `interface/type`

Name and type of the physical interface or bond group.

**eth-oam modify**

Modifies a configured **eth-oam** interface.

**Syntax** `eth-oam modify interface/type [active | passive]`

**Options** `interface/type`

Name and type of the physical interface or bond group.

**eth-oam show**

Displays configured OAM parameters for the specified interface. If no interface is specified, configured OAM parameters are displayed for all OAM enabled interfaces.

**Syntax** `eth-oam show interface/type [peer]`

**Options** `interface/type`

Name and type of the physical interface or bond group.

**peer**

Displays the learned configuration information of the peer for the given interface. Includes peer MAC address, peer vendor OUI, peer vendor unique info, peer mode, peer max OAM PDU size, peer configuration revision, peer supported functions.

**eth-oam stats**

Displays OAM statistics for the specified interface. If no option is specified, statistics are displayed for all OAM interfaces.

**Syntax** `eth-oam stats interface/type`

**Options** `interface/type`

Name and type of the physical interface or bond group.





# 10

## IP SERVICE LEVEL AGREEMENT

This chapter describes IP Service Level Agreement (IPSLA) for the EtherXtend 3400:

- [Overview, page 137](#)
- [IPSLA, page 137](#)

### Overview

The IP Service Level Agreement (IPSLA) feature assists service providers and network operators with enforcing and monitoring access network connections and performance. IPSLA uses ICMP Ping messages over configured IPSLA paths to track Round Trip Times (RTTs) and ECHO REQs/RSPs between initiator and responder devices to determine network performance and delays. Typically, one initiator device is used to monitor other responder devices in the network. A maximum of 32 IPSLA paths can be configured per MALC and 4 IPSLA paths per EtherXtend 3400.

### IPSLA

Initiator devices must be running IPSLA to request data for a responder device. Responder devices must be configured to respond to ICMP messages. Responder devices not running IPSLA display limited statistical data and functionality.



**Note:** Networks must support CoS queues and DSCP to provide valid per CoS statistics. Otherwise, all statistics are sent to the default CoS queue.

---

Default CoS-actions are assigned to each CoS queue so threshold crossing alarms can be configured to generate system alarms when thresholds are crossed for uptime, latency, jitter, and packet size.

Data based on received/sent packets and train rates is collected and displayed as real-time statistics for the current 15 minute interval as well as over 96 15-minute intervals for 24 hour historical statistics.

By default, IPSLA is disabled on all EtherXtend 3400, MALC card ports and other SLMS devices. [Figure 20](#) illustrates a IPSLA configuration.

**Figure 20: IPSLA**

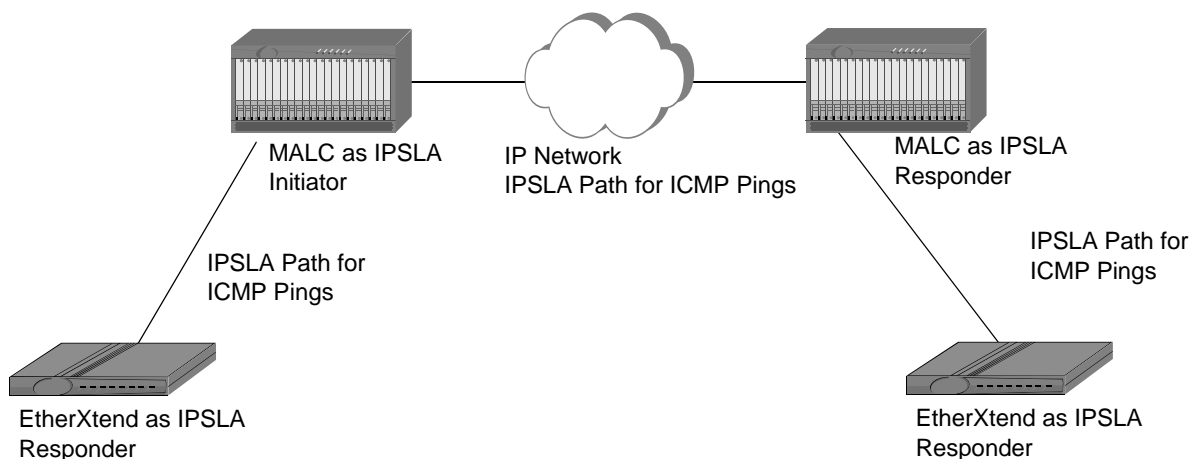

### Configuring IPSLA

IPSLA requires the following configuration steps:

- Set ipsla-global settings to enable device state and optionally set polling interval
- Create ICMP path between devices
- Optionally modify CoS actions for the desired CoS queues
- Optionally modify CoS map for Diff Server Control Point (DSCP) mappings

To configure IPSLA:

IPSLA global parameters shown in [Table 26](#) determine if the feature is active, and if globally enabled, determine the time interval between outgoing IPSLA Pings.

**Table 26: IPSLA globe I**

Parameter	Value	Description
state	enabled/disables	IPSLA global feature activity
pollseconds	60...3600	The interval between outgoing IPSLA pings in seconds.

- 1 Enable IPSLA and set IPSLA ping interval.
  - a View the global IPSLA settings by entering **ipsla show global**.

```
zSH> ipsla show global
state: -----> {disabled}
pollseconds: -> {60}
```

The polling interval (60 to 3600 seconds) is used for real-time and historical statistics.

- b** Enter **ipsal modify global state *value* pollseconds *value*** to enable IPSLA and set the pollseconds interval.

```
zSH> ipsal modify global state enabled pollseconds 120
```

- c** Verify the IPSLA settings.

```
zSH> ipsla show global
state: -----> {enabled}
pollseconds: -> {120}
```

- 2** Create a ICMP path between devices. The device on which this command is entered becomes the initiator device, while the device for which an IP address is entered becomes the responder device. Typically, one initiator device can be used to monitor other responder devices in the network over a maximum of 32 MALC and 4 EtherXtend 3400 IPSLA paths per device.

- a** Enter the **ipsla add path** command to create the path.

```
zSH> ipsla add path ipAddress 172.16.78.11
```

- b** Enter **ipsla show path** command to verify that the IP address was added.

```
zSH> ipsla show path
Path configuration for ipAddress: 172.16.78.11
forwarding: -> {disabled}
state: -----> {enabled}
```

- c** Modify the path using the IPSLA **modify path** command. This example disables the static path on device 192.168.254.17.

```
zSH> ipsla modify path ipAddress 192.168.254.17 state disabled
```

- d** Delete a path using the **ipsla delete** command.

```
zSH> ipsla delete path ipAddress 192.168.254.17
```

---

 **Note:** Disabling or deleting the path or globally disabling the IPSLA feature will reset historical data.

---

- 3** Modify the default CoS actions to specify the response and threshold behavior for each CoS action index (1-8). These CoS actions map respectively to the CoS queues (0-7) as shown in [Table 27](#). The following CoS actions are defined by default.

**Table 27: CoS action index map to CoS queues**

Default name	CoS action index	CoS queue
Default	1	0
AFClass 1	2	1

**Table 27: CoS action index map to CoS queues (Continued)**

Default name	CoS action index	CoS queue
AFClass 2	3	2
AFClass 3	4	3
AFClass4	5	4
Cos-5	6	5
ExpFwd	7	6
NetwCtrl	8	7

Each CoS action contains parameters as shown in [Table 28](#):

**Table 28: CoS action parameters**

Parameter	Description	Default
Name	Name of the IPSLA CoS action, up to 9 characters in length.	(1) Default, (2) AFClass1, (3) AFClass2, (4) AFClass3, (5) AFClass4, (6) Cos-5, (7) ExpFwd, (8) NetwCtrl
Traps	Specifies whether a trap is issued when any SLA performance error threshold within this CoS is crossed.	disabled/enabled
Timeouts	Specifies the number of consecutive missed IP SLA responses within this CoS before a zhoneIpSLATimeoutTrap is issued.	1...20
Timeout Clear	Specifies the number of consecutive IPSLA responses within this CoS which must be received before the timeout error condition is cleared.	1 sample
Latency	Specifies the 15 sample average roundtrip latency value which must be exceeded within this CoS before a zhoneIpSLALatencyTrap is issued.	50...10000 milliseconds
Latency Clear	Specifies the number of consecutive IPSLA latency samples for which the 15 sample average roundtrip latency must be below the configured SLA latency error threshold within this CoS before the latency error condition is cleared.	1 sample
Jitter	Specifies the 15 sample roundtrip jitter value which must be exceeded within this CoS before a zhoneIpSLAJitterTrap is issued.	50...10000 milliseconds
Jitter Clear	Specifies the number of consecutive IPSLA RTT samples for which the 15 sample roundtrip jitter must be below the configured SLA jitter error threshold within this CoS before the jitter error condition is cleared.	1 sample
Packetsize	Specifies the minimum IPSLA Ping packet size in bytes. The range is 64 thru 2048 if the target IP device is running IPSLA, 64 thru 512 otherwise.	64...2048 bytes

- a** Display the settings for an individual CoS action. The CoS Action determines IPSLA performance thresholds per CoS and how or whether to react to threshold crossings. The IPSLA Ping packet size may also be set in CoS Action.

```
zSH> ipsla show cos-action cosactionindex 1
Cos Action Configuration for cosActionIndex: 1:
name: -----> {Default}
traps: -----> {disabled}
timeOuts: ----> {3}
latency: ----> {10000}
jitter: -----> {10000}
packetSize: -> {64}
```

Or

- b** Display the settings for all CoS actions (1-8).

```
zSH> ipsla show cos-action
Cos Action Configuration for cosActionIndex: 1:
name: -----> {Default}
traps: -----> {disabled}
timeOuts: ----> {3}
latency: ----> {10000}
jitter: -----> {10000}
packetSize: -> {64}
```

```
Cos Action Configuration for cosActionIndex: 2:
name: -----> {AFClass1}
traps: -----> {disabled}
timeOuts: ----> {3}
latency: ----> {10000}
jitter: -----> {10000}
packetSize: -> {64}
```

```
Cos Action Configuration for cosActionIndex: 3:
name: -----> {AFClass2}
traps: -----> {disabled}
timeOuts: ----> {3}
latency: ----> {10000}
jitter: -----> {10000}
packetSize: -> {64}
```

```
Cos Action Configuration for cosActionIndex: 4:
name: -----> {AFClass3}
traps: -----> {disabled}
timeOuts: ----> {3}
latency: ----> {10000}
jitter: -----> {10000}
packetSize: -> {64}
```

```
Cos Action Configuration for cosActionIndex: 5:
name: -----> {AFClass4}
traps: -----> {disabled}
```

```

timeOuts: ---> {3}
latency: ----> {10000}
jitter: -----> {10000}
packetSize: -> {64}

Cos Action Configuration for cosActionIndex: 6:
name: -----> {Cos-5}
traps: -----> {disabled}
timeOuts: ---> {3}
latency: ----> {10000}
jitter: -----> {10000}
packetSize: -> {64}

Cos Action Configuration for cosActionIndex: 7:
name: -----> {ExpFwd}
traps: -----> {disabled}
timeOuts: ---> {3}
latency: ----> {10000}
jitter: -----> {10000}
packetSize: -> {64}

Cos Action Configuration for cosActionIndex: 8:
name: -----> {NetwCtrl}
traps: -----> {disabled}
timeOuts: ---> {3}
latency: ----> {10000}
jitter: -----> {10000}
packetSize: -> {64}

```

- c** Modify a cos-action by specifying the desired parameters to change in the command line. This example enables traps for **cosActionIndex 1**.

```
zSH> ipsla modify cos-action cosactionindex 1 traps enabled
```

- d** Verify the change by entering **ipsla show**.

```

zSH> ipsla show cos-action cosactionindex 1
Cos Action Configuration for cosactionindex: 1:
name: -----> {Default}
traps: -----> {enabled}
timeouts: ---> {3}
latency: ----> {10000}
jitter: -----> {10000}
packetSize: -> {64}

```

- e** Modify another cos-action, in this case the latency threshold to 5000 milliseconds.

```
zSH> ipsla modify cos-action cosactionindex 1 latency 5000
```

- f** Verify the change by entering **ipsla show**.

```
zSH> ipsla show cos-action cosactionindex 1
```

```

Cos Action Configuration for cosactionindex: 1:
name: -----> {Default}
traps: -----> {enabled}
timeouts: ----> {3}
latency: ----> {5000}
jitter: -----> {10000}
packet-size: -> {64}

```

#### 4 Change alarm-clearing thresholds, if necessary.

The **latency-clear** parameter sets the criteria for when a trap (alarm) is sent based on how often a sample is taken.

##### a View the current settings with **get ipsla-cos-act** *index number*.

```

zSH> get ipsla-cos-act 1
ipsla-cos-act 1
name: -----> {Default}
traps: -----> {enabled}
timeouts: -----> {3}
timeout-clear: -> {1}
latency: -----> {5000}
latency-clear: -> {1}
jitter: -----> {10000}
jitter-clear: --> {1}
metrics: -----> {enabled}
packet-size: ----> {64}

```

##### b Change the alarm-clearing threshold, in this case for **latency-clear**, with **update ipsla-cos-act** *index number*. update ipsla-cos-act 1

```

zSH> update ipsla-cos-act 1
ipsla-cos-act 1
Please provide the following: [q]uit.
name: -----> {Default}:
traps: -----> {enabled}:
timeouts: -----> {3}:
timeout-clear: -> {1}:
latency: -----> {5000}:
latency-clear: -> {1}: 4
jitter: -----> {10000}:
jitter-clear: --> {1}:
metrics: -----> {enabled}:
packet-size: ----> {64}:
.....
Save changes? [s]ave, [c]hange or [q]uit: s
Record updated.

```

##### c Verify the change by entering **get ipsla-cos-act** *index number*.

```

zSH> get ipsla-cos-act 1
ipsla-cos-act 1
name: -----> {Default}
traps: -----> {enabled}
timeouts: -----> {3}

```

```

timeout-clear: -> {1}
latency: -----> {5000}
latency-clear: -> {4}
jitter: -----> {10000}
jitter-clear: --> {1}
metrics: -----> {enabled}
packet-size: ---> {64}
    
```

- 5 Configure the desired CoS maps to modify the default DSCP to CoS action index mappings. By default, DSCP are mapped to CoS action index entries based of RFC 2599. [Table 29](#) shows the default mappings. A CoS action index of 0 indicates that the DSCP is not used.

**Table 29: DSCP mapping to CoS action index**

DSCP	CoS action index
1	8
11, 13, 15	7
19, 21, 23,	6
27, 29, 31	5
35, 37, 39	4
41	3
47	2
49, 57	1
2, 3, 4, 5, 6, 7, 8, 9, 10, 12, 14, 16, 17, 18, 20, 22, 24, 25, 26, 28, 30, 32, 33, 34, 36, 38, 40, 42, 43, 44, 45, 46, 48, 50, 51, 52, 53, 54, 55, 56, 58, 59, 60, 61, 62, 63, 64	0

Display the CoS map for an individual CoS action or for all CoS actions.

```

zSH> ipsla show cos-map
dscpIndex: 1      cosActionIndex: 1
dscpIndex: 2      cosActionIndex: 0
dscpIndex: 3      cosActionIndex: 0
dscpIndex: 4      cosActionIndex: 0
dscpIndex: 5      cosActionIndex: 0
dscpIndex: 6      cosActionIndex: 0
dscpIndex: 7      cosActionIndex: 0
dscpIndex: 8      cosActionIndex: 0
dscpIndex: 9      cosActionIndex: 0
dscpIndex: 10     cosActionIndex: 0
dscpIndex: 11     cosActionIndex: 2
dscpIndex: 12     cosActionIndex: 0
dscpIndex: 13     cosActionIndex: 2
dscpIndex: 14     cosActionIndex: 0
dscpIndex: 15     cosActionIndex: 2
dscpIndex: 16     cosActionIndex: 0
    
```



```
dscpIndex: 17   cosActionIndex: 0
dscpIndex: 18   cosActionIndex: 0
dscpIndex: 19   cosActionIndex: 3
Type A<CR> to print all, <CR> to continue, Q<CR> to
stop:
```

Specify the desired index values in the command line to change the mapping of the DSCP index to CoS action index. This example changes the mapping of DSCP index 1 to CoS action index 7. Because the DSCP indexes (1-64) map respectively to the DSCP values (0-63), and the CoS action index (1-8) map respectively to the CoS queues (0-7), so this change also changes the mapping of DSCP value 0 to CoS queue 6.

```
zSH> ipsla modify cos-map dscpindex 1 cosactionindex 7
```

To clear a CoS map, specify the desired index values in the IPSLA command to delete the mapping of the DSCP index for the CoS queue. This example clears the mapping of DSCP index 1 and resets it to the CoS queue 0.

```
zSH> ipsla modify cos-map dscpindex 1 cosactionindex 0
```

- 6 Display real-time statistics for path or CoS queue. Real-time statistics represent minimum, maximum, average, and current values over the current 15 minute polling period based on data collected for each polling intervals. For example, if the polling interval is configured for 60 seconds, the real-time statistics display the data compiled from the latest 15 60-second polling intervals contained in the current polling period.

---

 **Note:** RTT values of 0 (zero) indicate a lack of data, while sub-millisecond RTTs are reported as 1.

---

These statistics can be displayed individually or collectively for a specified IP address or for all configured paths.

---

 **Note:** When a card swact occurs, historical data does not failover and data for the 15-minute interval during which the swact occurred may be lost.

---

```
zSH> ipsla stats path ipaddress 192.168.254.15
```

Target IP Address	Target name	Target type	A/C/T	Source IP	C/N/X	UpTime (secs)	I/R	# CoS mismatch
192.168.254.15	Unknown	Unknown	Y	192.168.254.166	S	4357	I	0

```
zSH> ipsla stats path
```

Target IP Address	Target name	Target type	A/C/T	Source IP	C/N/X	UpTime (secs)	I/R	# CoS mismatch
-------------------	-------------	-------------	-------	-----------	-------	---------------	-----	----------------

```

-----+-----+-----+-----+-----+-----+-----+
 172.16.78.11| Unknown| Unknown| Y| 192.168.254.166| S| 14723| I| 30|
 192.168.254.15| Unknown| Unknown| Y| 192.168.254.166| S| 14723| I| 171|
 192.168.254.17| Unknown| Unknown| Y| 192.168.254.166| S| 14723| I| 30|

```

Table 30 explains the statistics for the configured paths.

**Table 30: Statistics for configured paths**

Path statistic	Description
Target IP Address	IP Address of the device which is at the other end of the path.
Target Name	Name of the remote device.
Target Type	Type of the remote device.
ACT	Availability status of the remote device.
Source IP	IP Address of the discovery source device.
CNX	Type of path either static or dynamic.
UpTime (secs)	Amount of time in seconds that elapsed since the last transition from Inactive to Active.
I/R	Role played by the local device in collection of latency and availability statistics. Initiator - Device that initiates the IPSLA ping packet used for statistics collection; Responder - Device that returns the IPSLA ping packet sent by the Initiator.
CoS Mismatch	Number of IPSLA ping packets received which indicate a mismatch between the Class Of Service (CoS) definitions at the remote unit and those of the source unit.

Display real-time CoS statistics individually or collectively by CoS action index, IP address or all CoS actions.

```
zSH> ipsla stats cos cosActionindex 1
```

```

-----+-----+-----+-----+-----+-----+-----+
Cos|      Target IP | A | Last | Min | Avg | Max | Drop |
Idx|      Address   | T | RTT  | RTT | RTT | Rtt  | Resp |
-----+-----+-----+-----+-----+-----+
 1 | 10.2.1.254    | Y | 0    | 0   | 0   | 0    | 2    |
 1 | 172.24.94.254| Y | 0    | 0   | 0   | 0    | 1    |

```

```
zSH> ipsla stats cos ipaddress 10.2.1.254
```

```

-----+-----+-----+-----+-----+-----+-----+
Cos|      Target IP | A | Last | Min | Avg | Max | Drop |
Idx|      Address   | T | RTT  | RTT | RTT | Rtt  | Resp |
-----+-----+-----+-----+-----+-----+
 1 | 10.2.1.254    | Y | 0    | 0   | 0   | 0    | 2    |
 2 | 10.2.1.254    | Y | 0    | 0   | 0   | 0    | 0    |
 3 | 10.2.1.254    | Y | 0    | 0   | 0   | 0    | 0    |

```

4	10.2.1.254	Y	10	10	10	10	0
5	10.2.1.254	Y	0	0	0	0	0
6	10.2.1.254	Y	0	0	0	0	1
7	10.2.1.254	Y	0	0	0	0	1
8	10.2.1.254	Y	0	0	0	0	1

zSH> ipsla stats cos

CoS Idx	Target IP Address	A C T	Last RTT	Min RTT	Avg RTT	Max Rtt	Drop Resp
1	172.16.78.11	Y	0	20	20	20	2
2	172.16.78.11	Y	0	10	10	10	0
3	172.16.78.11	Y	0	20	20	20	0
4	172.16.78.11	Y	0	0	0	0	0
5	172.16.78.11	Y	0	130	130	130	0
6	172.16.78.11	Y	0	340	340	340	0
7	172.16.78.11	Y	0	0	0	0	1
8	172.16.78.11	Y	0	380	380	380	0
1	192.168.254.15	Y	0	0	0	0	11
2	192.168.254.15	Y	0	0	0	0	9
3	192.168.254.15	Y	0	0	0	0	9
4	192.168.254.15	Y	0	0	0	0	9
5	192.168.254.15	Y	0	0	0	0	10
6	192.168.254.15	Y	0	0	0	0	9

Type A<CR> to print all, <CR> to continue, Q<CR> to stop: a

CoS Idx	Target IP Address	A C T	Last RTT	Min RTT	Avg RTT	Max Rtt	Drop Resp
7	192.168.254.15	Y	0	0	0	0	9
8	192.168.254.15	Y	0	0	0	0	9
1	192.168.254.17	Y	0	10	10	10	1
2	192.168.254.17	Y	0	20	20	20	1
3	192.168.254.17	Y	0	0	0	0	0
4	192.168.254.17	Y	0	10	10	10	0
5	192.168.254.17	Y	0	80	80	80	0
6	192.168.254.17	Y	0	350	350	350	0
7	192.168.254.17	Y	0	150	150	150	0
8	192.168.254.17	Y	0	280	280	280	0

Table 31 explains the CoS action index statistics.

Table 31: CoS action index statistics

CoS action index statistic	Description
CoS Index	Index number of the CoS action index.
Target IP Address	IP Address of the device which is at the other end of the path.

**Table 31: CoS action index statistics (Continued)**

CoS action index statistic	Description
Last RTT	RTT reported in the most recent successful ping attempt.
Min RTT	Smallest RTT since this statistic was last cleared to a zero value.
Avg RTT	Average RTT since this statistic was last cleared to a zero value. Calculated as (RTT1 + RTT2 + RTT3 + .....+RTTn)/n where n equals the number of successful ping attempts since this statistic was last cleared to a zero value.
Max RTT	Largest RTT since this statistic was last cleared to a zero value.
Drop Resp	Number of failed pings since this statistic was last cleared to a zero value.

Display historical statistics individually or collectively based on IP address, CoS action index, and index value of a 15 minute interval. Historical statistics are displayed for the latest 24 hour period or a specified 15 minute interval within the latest 24 hour period.

 **Note:** It is required to specify at least two of these three instancing values: cosactionindex, IP address, and index. For example, the combination of cosactionindex and IP address, or the combination of index and cosactionindex, or the combination of index and IP address.

For historical statistics, IPSLA averages values for the most recent 96 15-minute intervals and displays the minimum, maximum, average and current values in a table for a 24 hour summary.

```
zSH> ipsla stats history cosactionindex 1 ipaddress 172.16.78.11
```

I	C	Target IP	DateTime	A	Min	Avg	Max	Drop
n	O	Address	mm/dd/yy, hh:mm:ss	C	RTT	RTT	Rtt	Resp
t	S			T				
1	1	172.16.78.11	09/04/07-13:09:41	Y	0	0	0	1
2	1	172.16.78.11	09/04/07-13:24:41	Y	0	0	0	1
3	1	172.16.78.11	09/04/07-13:39:41	Y	0	0	0	1
4	1	172.16.78.11	09/04/07-13:54:41	Y	0	0	0	1
5	1	172.16.78.11	09/04/07-14:09:41	Y	0	0	0	1

Type A<CR> to print all, <CR> to continue, Q<CR> to stop:

```
zSH> ipsla stats history ipaddress 10.2.1.254 index 1
```

I	C	Target IP	DateTime	A	Min	Avg	Max	Drop
n	O	Address	mm/dd/yy, hh:mm:ss	C	RTT	RTT	Rtt	Resp
t	S			T				
1	1	10.2.1.254	09/12/07-21:48:58	Y	0	0	0	2

1	2	10.2.1.254	09/12/07-21:48:58	Y	0	0	0	0
1	3	10.2.1.254	09/12/07-21:48:58	Y	0	0	0	0
1	4	10.2.1.254	09/12/07-21:48:58	Y	0	0	0	0
1	5	10.2.1.254	09/12/07-21:48:58	Y	0	0	0	0
1	6	10.2.1.254	09/12/07-21:48:58	Y	0	0	0	1
1	7	10.2.1.254	09/12/07-21:48:58	Y	0	0	0	1
1	8	10.2.1.254	09/12/07-21:48:58	Y	0	0	0	1

zSH> **ipsla stats history index 1 cosactionindex 3**

I	C	Target IP	DateTime	A	Min	Avg	Max	Drop
n	O	Address	mm/dd/yy, hh:mm:ss	C	RTT	RTT	Rtt	Resp
t	S			T				
1	3	10.2.1.254	09/12/07-21:48:58	Y	0	0	0	0
1	3	172.24.94.254	09/12/07-21:48:58	Y	0	0	0	0



# INDEX

## Numerics

4-port EtherXtend SHDSL 14

## A

ARP, broadcasts and bridging 88

ATM

bridging and IP support on VC 86

automatic baud rate detection

SDSL 73

## B

bridge statistics 119

bridging 89

adding untagged bridge 93

administrative commands 118

ARP broadcast 88

broadcasts and 88

custom DHCP server 103

intralinks 84

overview 83

support on VC 86

VLAN 89

VLAN configuration 89

VLAN overview 88

VLAN strip and insert 102

broadcast suppression, described 103

## C

card-profile, setting 63

changepass command 58

chassis

environmental specifications 38

fans 38

operating altitude 38

operating humidity 38

operating temperature 38

storage altitude 38

storage humidity 38

storage temperature 38

unpacking 39

Class of Service (COS) 98, 106

commands

changepass 58

dslstat 76

showlinestatus 76

configuration

basic 47, 71, 121, 137

Ethernet

interface 65

management channel 65

fundamentals 47, 71, 121, 137

description 47, 71, 121, 137

interface types 47, 71, 121, 137

local management channel 48

logging in 48

logging out 48

SDSL/SHDSL interface 74

system security 58

verifying interfaces 76

configuring management interface

accessing the serial port 48

local management channel 48

logging in and out 48

configuring physical interfaces

SDSL/SHDSL interfaces 74

verifying interfaces 76

COS, in VLAN headers 98, 106

craft interface 48

## D

device settings 63

devices

8-port EtherXtend SHDSL 14

DHCP

broadcast suppression 103

custom DHCP setting in bridge records 103

documents related to this guide 11

DSL

fixed bit rate settings and training rates 74

DSL interfaces

verifying the interface 76

**E**

- EFM
  - supported applications 17
  - technology description 15
- EFM media
  - copper services 16
- environmental requirements
  - precautions 38
  - specifications 38
- Ethernet
  - interface
    - configuration 65
    - management channel 65
- Ethernet interface
  - creating a default route 51
  - route show command 51
  - verifying 50
  - verifying the route 51
- EtherXtend product family 14

**I**

- installation
  - unpacking the system 39
- installation precautions
  - environmental requirements 38
- interface types, configuration of 47, 71, 121, 137
- interfaces
  - line speeds for DSL interfaces with fixed bit rates 74
- Intralinks
  - configuring 84
- IP
  - support on VC 86
- IPSLA 137

**L**

- local management channel 48
- logging
  - enabling/disabling for session 63
  - enabling/disabling over the serial craft port 63
- logging in and out
  - description 48
  - logout command 48
  - timeout command 48
- loop bonding 16

**M**

- modems
  - DSL training rates 74

**O**

- overview 13

**P**

- packet-rule 102
- password
  - changing default user password 58
- power specifications
  - DC power 38
  - description 38
  - rated power 38
- preparing for installation
  - selecting the system location 37
  - tools you need 37

**R**

- RADIUS 59
- rated power 38

**S**

- SDSL/SHDSL interfaces
  - configuration 74
- security
  - changing default user password 58
  - selecting the system location 37
- service level agreement, SLA 137
- SHDSL interfaces
  - verifying the interface 76
- specifications
  - environmental 38
- statistics, bridge interfaces 119
- strip and insert
  - configuring 102
- system
  - configuring management interface 48
  - unpacking 39
- system environmental dimensions
  - fans 38
  - operating altitude 38
  - operating humidity 38



- operating temperature 38
- storage altitude 38
- storage humidity 38
- storage temperature 38

## **T**

- tagged bridging
  - described 83
- terminal interface, settings for 48
- tools for installation 37

## **U**

- untagged bridging
  - described 83

## **V**

- VLAN IDs supported 89
- VLANs
  - adding bridge 89
  - configuring 88, 89
  - IDs supported 89
  - overview 88
  - strip and insert 102

