

Integrated Access Device

System Reference Guide

Publication 2000–R
Revision A0

IMACS System
Release 5.1.4
June 2001

Trademarks:

5ESS is a registered trademark of Lucent Technologies

DMS-100 and DMS-200 are trademarks of Northern Telecom.

Nortel is a trademark of Northern Telecom.

HyperTerminal is a registered trademark of Microsoft

Premisys is a registered trademark of Premisys Communications, Inc.

SLC is a registered trademark of Lucent Technologies

Windows 3.1 and 95 are registered trademarks of Microsoft

All other trademarks and registered trademarks are the property of their respective holders.

FCC Registration number:

1H5SNG-73866-DD-E (integral CSU)

B468NR-68618-DM-E (internal modem)

Canadian Certification number: 1932 5217 A

Canadian DOC Load number: 5

Ringer Equivalence Number: 0.2A (internal modem)

Approvals:

UL listed to UL# 1459 Second Edition, Third Edition

CSA listed to C22.2 No. 950-M89

COPYRIGHT © 1992-2001 Premisys Communications, Inc. All rights reserved.

This publication is protected by federal and international copyright law. No part of this publication may be copied or distributed, transmitted, transcribed, stored in a retrieval system, or translated into any human or computer language in any form or by any means, electronic, mechanical, magnetic, manual or otherwise, or disclosed to third parties without the express written permission from the manufacturer.

The manufacturer makes no representation or warranties with respect to the contents hereof and specifically disclaims any implied warranties of merchantability or fitness for a particular purpose. Further, the manufacturer reserves the right to revise this publication and to make changes from time to time in the contents hereof without obligation from the manufacturer to notify any person of such revision or changes.

License

Subject to the PREMISYS standard terms and conditions of sale or, if applicable, an existing sales agreement between our companies, PREMISYS grants and you accept a perpetual, non-exclusive license to use any object code software provided by PREMISYS (the Licensed Program) only with PREMISYS supplied equipment up to the number of cards at your company's location or at the locations of users who have acquired PREMISYS equipment through your company as provided in the upgrade purchase agreement. In no event will the rights to copy, transfer or transmit the Licensed Program exceed the prescribed quantity limitation in the upgrade purchase agreement. All other terms of the Software License and Warranty remain in effect.

Product Description - Release 5.1.4

Release 5.1.4 is a maintenance host release for the 5.1 platform. The functional enhancements involve the host firmware and the addition of a new FXO card to the Integrated Access System. These new features are described below.

New System Features

New features added to the 5.1 major release are:

- T1 HDSL WAN card based on PairGain HDSL module (802060 w/ 82100)
- 10Base2 IP Router Card (883060)
- 10BaseT IP Router Card (883160)

New features added to the 5.1.4 maintenance release are:

- Supports new FXO card, 813970, adding two new states machines, FXO_GS2 and FXO_GS2-A, that improve the Ground Start function, while automatically maintaining 813960 functionality;
- Improves distinctive ring patterns;
- Corrects GS handshaking and GS OHD operation;
- Simplifies screen selection of OHD Timeout for FXO;
- Improves operation of Trunk Conditioning;
- Improves Loop Start and Ground Start ring detect circuits.

CPU Card Supported in Release 5.1.4

Host code 5.1.4 operates on the 880360 CPU card and requires 60514 Host Firmware. No other CPU Cards are supported.

Interface Cards Supported in Release 5.1.4

Host code 5.1 is compatible with all Interface Cards with 128K NVRAM, models 8922xx, 8923xx, or 8924xx series. No other Interface Cards are supported.

System Cards

CPU XCON (880360)

The 880360 CPU XCON supports complex applications requiring more than two WAN ports and the ability to cross-connect DS0s between WANs. The 880360 supports up to four WAN Cards for a total of eight T1 or E1 WAN ports and has a built-in cross-connect module. A system that uses an 880360 CPU Card operates in “cross-connect” mode. Two Model 880360 CPUs can be installed in slots C1 and C2 to achieve CPU redundancy. The 880360 also supports 1xN WAN and Power Supply redundancy.

The CPU XCON Card controls the Integrated Access System. It performs the following functions:

- Initializes the system upon power-up and tests all installed cards.
- Polls all cards in the system every half second to determine operating status.
- Processes all incoming operator commands and displays the responses in a series of operator interface screens for each card in the system via a local VT-100 terminal, remote computer, or network management system.
- Includes circuitry that allows cross-connection of DS0 time slots between T1 and E1 lines connected to the system WAN cards.
- Includes a test pattern generator for T1 and E1 line test purposes.
- Performs primary CPU arbitration and redundancy if so configured.

Voice Cards

This host code release supports the following voice cards:

- **E&M** **E&M 2W*8 (810860), E&M-LB 4W*8 (811760),
E&M 4W*8 (811960)**
*E&M 2W*4-6 (8104), E&M 4W*2-6 (8812), E&M Wx2ER (8113)
E&M 4W*4-6 (8114), E&M 4W*ER (8115), E&M 4W*8-6 (8118)*
- **FXS** **FXS 2W*8-6 (812960)**
*FXS 2W*2-9 (8122), FXS 2W*2-6 (8123), FXS 2W*4-9 (8124),
FXS 2W*4-6 (8125), FXS 2W*8-9 (8128)*
- **FXO** **FXO 2W*8-6 (813960), FXO 2W*8-6 (813970)**
*FXO 2W*2-9 (8132), FXO 2W*2-6 (8133),
FXO 2W*4-9 (8134), FXO 2W*4-6 (8135),
FXO 2W*8-9 (8138),*
- **FXS-C** **FXS-C 2W*8-6 (814960)**
FXS-C 6-900 (8148)
- **FXO-C** **FXO-C 2W*8-6 (815960)**
FXO-C 8-900 (8158)
- **LBVR** **LBVR-8 Fax (830060)**
- **P-Phone** **PPO 2W*8-6 (813160), PPS 2W*8-6 (812160)**



Note: Cards listed in italics have been Manufacturing Discontinued (MD), but are supported under this product host code for backward compatibility.

Data Cards

This host code release supports the following data cards:

- **HSU** **HSU*2 530/35 (820260), HSU-T 530 (820360),
HSU 35 (821260), HSU-AD 530/35 (821360),
HSU-T 530/35 (821460), HSU*4 530/35 (821570),
HSU*4E 530/35 (821660)**
- **SRU** **SRU 232*10 (822060), SRU-232*10 (822160)**
- **OCU-DP** **OCU-DP 5 (824160), OCU-DP 10 (824660), OCU-DP (8249)
*OCU-DP 5 (8247), OCU-DP 5 (8248)***
- **FRAD** **FRAD 232*10 (823160)
*FRAD-18 (8230)***
- **DS0-DP** **DS0-DP 4 (825460)**
- **BNR** **BNR 232*8 (822860)**
- **BRI** **BRI U*8 (826070), BRI-SC U*8 (826171), BRI-ST*8 (826270)**
- **PM-IOR** **PM-IOR (828060)**



Note: *Cards listed in italics have been Manufacturing Discontinued (MD), but are supported under this product host code for backward compatibility.*

Server Cards

This host code release supports the following server cards:

- **ADPCM** **ADPCM 64 (887160)**
- **FRS** **ACS-FRS (881160)**
- **MCC** **ACS-MCC (881360)**
- **ATM** **ACS-ATM (882060)**
- **ISDN-PRI** **ISDN-PRI (884060)**
- **PRI-BRI** **ACS-PRI (881162)**
- **IMUX** **IMUX (8880)**
- **IPR** **IPR 10B2 (883060), IPR 10BT (883160), IPR (881161)**



Note: Cards listed in italics have been Manufacturing Discontinued (MD), but are supported under this product host code for backward compatibility.

Alarm Cards

This host code release supports the following alarm cards:

- **ALR** **ALR 4+4 (840160), ALR 4+3PF (840260), ALR 28+14 (840360)**

Optional Features

- TR-08 firmware

Using this Reference Documentation

Reference documents for this product consists of several individual reference guides, each covering a specific set of user modules. Depending upon your application, the overall reference documentation may include the following complete reference guides.

- System (Common Equipment) Reference Guide
- Voice Card Reference Guide
- Data Card Reference Guide
- Alarm Card Reference Guide
- Server Card Reference Guide

System Reference Guide

This System Reference Guide assists technicians in unpacking, assembling, installing, configuring, and operating the integrated access device.

Chapter 1. *System Overview*

Chapter 2. *Applications*

Chapter 3. *System Installation*

Chapter 4. *System Configuration and Operation*

Chapter 5. *CPU Card*

Chapter 6. *Interface Card*

Chapter 7. *WAN Card*

Chapter 8. *System Testing and Diagnostics*

Appendix A. *System Specifications*

Appendix B. *Error Messages*

Appendix C. *Pinouts*

Glossary

User Card Reference Guides

There are four individual Reference Guides that cover the User Cards for this product. They are:

- The Voice Card Reference Guide (E&M, FXS, FXO, FXS-C, FXO-C and P-Phone PPO/PPS Cards)
- The Data Card Reference Guide (HSU, SRU, FRAD, OCU-DP, DS0-DP, B7R and BRI Cards)
- The Alarm Card Reference Guide (ALM)
- Server Card Reference Guide (ADPCM, FRS, MCC, ATM, ISDN-PRI, IMUX, and IPR Cards).

Customer Service and Ordering Information

Technical Support

If you require technical assistance with installation, operation, or maintenance of your system, or if you want to return a product under warranty for repair, please contact your distributor.

If you purchased this product from an authorized dealer, distributor, Value Added Reseller (VAR), or third party, please contact that vendor for technical assistance and warranty support.

Ordering Information

To order equipment, cables, or additional copies of this Reference Guide, please contact your distributor.

Safety Information and Precautions

The equipment is designed and manufactured in compliance with Safety Standard EN60950. However, the following precautions should be observed to ensure personal safety during installation or service, and prevent damage to the equipment or equipment to be connected.

Read and follow all warning notices and instructions marked on the product or included in this Reference Guide.

Only qualified technicians should perform these tasks.

1. Never install telephone wiring during a lightning storm.
2. Never install telephone jacks in wet locations unless the jack is specifically designed for wet locations.
3. Never touch uninsulated telephone wires or terminals unless the telephone line has been disconnected at the network interface.
4. Use caution when installing or modifying telephone lines.
5. See the UL Statement for Voice Cards.
6. Never attempt to remove the power panel without first disconnecting input power cables.
7. Never attempt to operate this system when the power panel screws are removed. They provide the safety ground for the system.
8. This product is intended to be used with a three-wire grounding type plug - a plug which has a grounding pin. This is a safety feature. Equipment grounding is vital to ensure safe operation. Do not defeat the purpose of the grounding type plug by modifying the plug or using an adapter.

Prior to installation, use an outlet tester or a voltmeter to check the AC receptacle for the presence of earth ground. If the receptacle is not properly grounded, the installation must not continue until a qualified electrician has corrected the problem. If a three-wire grounding type power source is not available, consult a qualified electrician to determine another method of grounding the equipment.

9. Slots and openings in the cabinet are provided for ventilation. To ensure reliable operation of the product and to protect it from overheating, these slots and openings must not be blocked or covered.



Notice!

DO NOT place anything directly on top of unit that can block air holes.

10. **DO NOT** allow anything to rest on the power cord and do not locate the product where persons could step on or walk on the power cord.
11. **DO NOT** attempt to service this product yourself. Refer all servicing to qualified service personnel.
12. Special cables, which may be required by the regulatory inspection authority for the installation site, are the responsibility of the customer.
13. When installed in the final configuration, the product must comply with the applicable Safety Standards and regulatory requirements of the country in which it is installed. If necessary, consult with the appropriate regulatory agencies and inspection authorities to ensure compliance.
14. A rare phenomenon can create a voltage potential between the earth grounds of two or more buildings. If products installed in separate buildings are **interconnected**, the voltage potential may cause a hazardous condition. Consult a qualified electrical consultant to determine whether or not this phenomenon exists and, if necessary, implement corrective action prior to interconnecting the products.



WARNING!

This equipment has been tested and found to comply with the limits for a Class "A" Digital Device, pursuant to Part 15 of the FCC Rules. These limits are designed to provide reasonable protection against harmful interference when the equipment is operated in a commercial environment. This equipment generates, uses, and can radiate radio frequency energy, and, if not installed and used in accordance with this Reference Guide, may cause harmful interference to radio communications. Operation of this equipment in a residential area is likely to cause harmful interference, in which case the user will be required to correct the interference at their own expense.

The authority to operate this equipment is conditioned by the requirement that no modifications will be made to the equipment unless the changes or modifications are expressly approved by the manufacturer.

Disclaimer for Shielded Cables

This equipment was tested with shielded input/output and interface cables. It is recommended that shielded cables be used to reduce interference whenever interference is suspected.

Panel and Cover Removal

Only qualified service technicians should attempt the removal of covers and panels.



Notice!

Never attempt to operate the equipment with the power panel fasteners removed. Do not remove power panel covers without first disconnecting the input power.

Power Source

Please refer to *Appendix A, System Specifications* in the System Reference Guide regarding System Requirements.

Fusing

To avoid a fire hazard, use only fuses with the specified type and rating.

Power Supply Safety Information

The following information applies to systems with power supplies.

1. An equipment grounding conductor not smaller in size than the ungrounded branch-circuit supply conductors must be installed as part of the circuit that supplies the product or system. Bare, covered or insulated grounding conductors are acceptable. Individually covered or insulated equipment grounding conductors shall have a continuous outer finish that is either green, or green with one or more yellow stripes. The equipment-grounding conductor must be connected to ground at the service equipment.
2. The receptacles in the vicinity of the product or system must be of a grounding type. The equipment-grounding conductors serving these receptacles are to be connected to earth ground at the service equipment.
3. The DC Power Source must comply with the limits of SELV, and must provide reinforced insulation from AC Power Mains.

Grounding

The equipment can be grounded through the power cord as well as the terminal marked .



Notice!

For detailed information on grounding procedures, please see the Grounding section in this Reference Guide.



Notice!

Passive Cooling Requirements

DO NOT Stack Units on top of one another. There MUST be at least 1” clearance between units.

Electrostatic Discharge Prevention

The plug-in cards contain components that could be damaged by electrostatic discharge. When handling any cards, wear a properly grounded wrist strap to prevent possible card damage, or follow other suitable precautions to prevent equipment damage.

Operator Services Requirements

This equipment is capable of giving users access to interstate providers of operator services through the use of equal access codes. Modifications by aggregators to alter these capabilities may be in violation of the Telephone Operator Consumer Services Improvement Act of 1990 and Part 68 of the FCC Rules.

Regulatory Compliance Information

FCC Part 68 Information

This equipment complies with Part 68 of the FCC rules.

The equipment has FCC Registration Number 1H5SNG-73866-DD-E. This equipment uses the following USOC jacks: RJ11C, RJ21X, RJ2EX, RJ2FX, RJ2GX and RJ2HX.

The Ring Equivalence Number (REN) is used to determine the quantity of devices that may be connected to the telephone line. Excessive RENs on the telephone line should not exceed five (5). To be certain of the number of devices that may be connected to the line, as determined by the total RENs, contact the telephone company to determine the maximum RENs for the calling area.

If this equipment causes harm to the telephone network, the telephone company will notify you in advance that temporary discontinuance of service may be required. If advance notice is not practical, the telephone company will notify you as soon as possible. Also, you will be advised of your right to file a complaint with the FCC if you believe it is necessary.

The telephone company may make changes in its facilities, equipment, operations, or procedures that could affect the operation of the equipment. If this happens, the telephone company will provide advance notice in order for you to make the necessary modifications to maintain uninterrupted service.

This equipment cannot be used on telephone company-provided coin service. Connection to Party Line Service is subject to state tariffs. This equipment is hearing aid-compatible.

CE Marking

The CE mark is affixed to those chassis that conform to the following Commission Directives:

- 89/336/EEC on the approximation of the laws of the Member States relating to electromagnetic compatibility.
- 73/23/EEC on the harmonization of the laws of the Member States relating to electrical equipment designed for use within certain voltage limits.
- 91/263/EEC on the approximation of the laws of the Member States concerning telecommunications terminal equipment, including the mutual recognition of their conformity.

Declaration of Conformity

Manufacturer

Zhone Technologies Inc.
7001 Oakport Street
Oakland, CA 94621
USA
Ph: (510) 777-7000

Authorized Representative in EC

2050 The Crescent
Solihull Parkway
Birmingham Business Park
Birmingham
B37 7YE
United Kingdom
Ph: 011-44-121-788-4100

We declare that the equipment listed herein conforms with the harmonized standards of the following European Commission Directives: 89/336/EEC, 72/23/EEC, and 91/263/EEC.

Name and Type of Equipment

IMACS/600, IMACS/800, IMACS/900 Integrated Multiple Access Communications Server

Under 89/336/EEC as amended by 92/31/EEC, and 93/68/EEC

In accordance with EN50081-1: EN55022
In accordance with EN50082-1

Under 72/23/EEC as amended by 93/68/EEC

EN60950 with Amendments A1 and A2

Under 91/263/EEC

In accordance with the following Common Technical Regulations:
CTR 12 - as described EC Type Examination Certificate BABT/97/4841
CTR 13 - as described EC Type Examination Certificate BABT/97/4841

CE MARK Affixed 1996

This Declaration is made 10 March 1998.

Country-Specific Regulatory Compliance Information

Canada

Canadian DOC Information

NOTICE TO USERS OF THE CANADIAN TELEPHONE NETWORK

The Canadian Department of Communications label identifies certified equipment. This certification means that the equipment meets certain telecommunications network protective, operational and safety requirements. The Department does not guarantee the equipment will operate to the user's satisfaction.

Before installing this equipment, users should ensure that it is permissible to be connected to the facilities of the local telecommunications company. The equipment must also be installed using an acceptable method of connection. In some cases, the company's inside wiring associated with a single line individual service may be extended by means of a certified connector assembly (telephone extension cord). The customer should be aware that compliance with the above conditions might not prevent degradation of service in some situations.

Repairs to certified equipment should be made by an authorized Canadian maintenance facility designated by the supplier. Any repairs or alterations made by the user to this equipment, or equipment malfunctions, may give the telecommunications company cause to request to disconnect the equipment.

Users should ensure for their own protection the electrical ground connection of the power utility, telephone line and internal metallic water pipe system, if present, are connected together. This precaution may be particularly important in rural areas.



CAUTION!

Users should not attempt to make such connections themselves, but should contact the appropriate electrical inspection authority, or electrician, as appropriate.

The Load Number (LN) assigned to each terminal device denotes the percentage of the total load to be connected to a telephone loop which is used by the device to prevent overloading. The termination on a loop may consist of any combination of devices subject only to the requirement that the total of all the Load Numbers of all the devices does not exceed 100.

Japan

Class A ITE Notification

この装置は、情報処理装置等電波障害自主規制協議会（VCCI）の基準に基づくクラス A 情報技術装置です。この装置を家庭環境で使用すると電波妨害を引き起こすことがあります。この場合には使用者が適切な対策を講ずるよう要求されることがあります。

Europe

European Telecommunication Approvals

Under the Telecommunications Terminal Directive the following connections are approved:

The WAN DUAL card, the WAN SINGLE card, and the 120 ohm version of the DSX/CEPT module are approved for connection to ONP unstructured and structured 2048 kbps digital leased lines with G.703 interfaces, following assessment against CTR12 and CTR13.

United Kingdom

UK Approval Number

The BABT approval number is M606037.

The WAN DUAL card, the WAN SINGLE card, and the 75 ohm version of the DSX/CEPT module, connected via the BNC connector panel are approved for connection to UK 2048 kbps digital leased lines with G.703 (75 Ohm) interfaces.

UK Compliance Statements

The E1 Interface is approved in the UK for direct connection to PTO-provided circuits operating at data rates up to 2.4Mbit/s.

The E1 Interface comprises a combination of single or dual WAN cards, CEPT modules, and connector panels as listed in the UK approval documentation.

The approved CEPT configuration options are shown below.

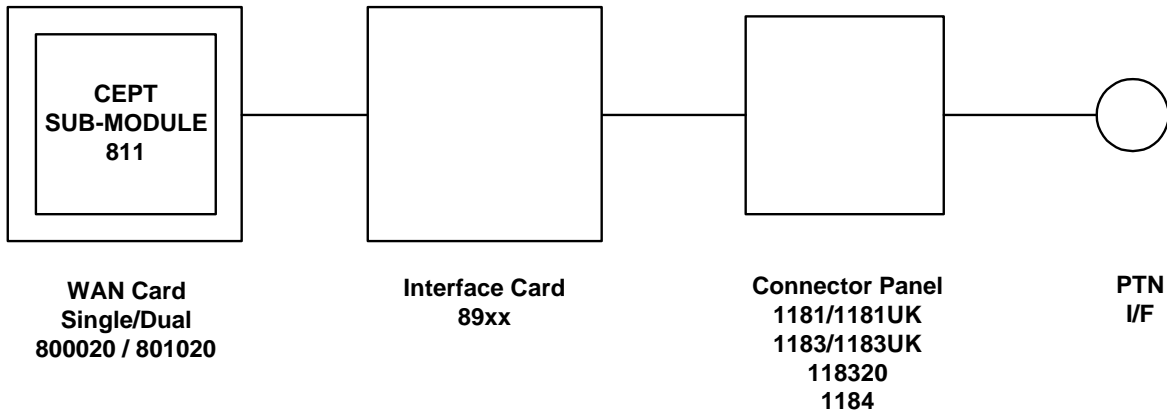

The Interface Card is also listed in the approval documentation and provides a direct metallic path between the CEPT module and appropriate Connector Panel.

The power required by the host and the total of all adapter cards installed within the host environment, together with any auxiliary apparatus, shall not exceed the power specification of the host apparatus.

Refer to Appendix A. System Specifications in this System Reference Guide for details on E1 interface power requirements.

It is essential when other option cards are introduced which use or generate a hazardous voltage, the minimum creepages and clearances are maintained. Suitable user protection to ensure compliance with EN 60950 should be present on the card. A hazardous voltage is one that exceeds 42.2V peak AC or 60VDC. If you have any doubt, seek advice from a competent installation engineer before installing other adapters into the host equipment.

The equipment must be installed such that with the exception of the connections to the host, clearance and creepage distances are maintained between the card and any other assemblies that use or generate a voltage. Large clearance and creepage distance applies where the local environment is subject to conductive pollution or dry non-conductive pollution which could become conductive due to condensation. Failure to maintain these minimum distances would invalidate the approval. Refer to Appendix A. System Specifications in this System Reference Guide.

Germany

German Approval Number

The German approval number is A118 142F.

Safety Warning

SPEZIFISCHE SICHERHEITSMABNAHMEN

DIE EINRICHTUNG IST GEMÄß DEM SICHERHEITSSTANDARD EN60950 ENTWORFEN UND HERGESTELLT WORDEN. DOCH DIE FOLGENDEN SICHERHEITSMABNAMEN SOLLEN EINGEHALTEN WERDEN. UM IHRE PERSÖNLICHE SICHERHEIT BEI INSTALLATION ODER BEI WARTUNG SICHERZUSTELLEN UND UM SCHADEN AN DER EINRICHTUNG ODER AN DER ZUM ANSCHLUß BESTIMMTEN EINRICHTUNG ZU VERMEIDEN.

ERDUNG

Die Einrichtung kann genauso durch das Netzanschlußkabel wie durch das mit gekennzeichnete Terminal geerdet werden.

STROMVERSORGUNG

Wechselspannung 120/240 Volts 2/1 Amps 50/60 Hertz

Gleichstrom 24/48 Volts 1/1.5 Amps

Die Gleichstromversorgung muß zusätzlich den Strom von der Versorgung abstellen können, und die Versorgungsspannung muß von einer isolierten Quelle gemäß der SELV-Voraussetzungen von EN60950 versorgt werden.

SCHMELZSICHERUNG

Um Brandgefahr zu vermeiden, dürfen Sie nur die Sicherung von der vorgeschriebenen Sorte und Nennwerte für die Einrichtung gebrauchen.

ENTFERNUNG VON PLATTEN UND ABDECKUNGEN

Die Abdeckungen und Platten sollen nur von einem qualifizierten Wartungs- oder Operationsperson entfernt werden.

Betreiben Sie nie die Einrichtung, wenn die Stromplattenverschlüsse entfernt worden sind, und entfernen Sie nie die Stromplattenabdeckung, ohne zuerst die Stromversorgung abzustellen.

Contents

1.1	Introduction	1-1
1.2	Chassis Types	1-2
1.2.1	Front-Loading Chassis with Power Supplies on the Side (891630).....	1-2
1.2.2	Two-Sided 891830 Chassis	1-4
1.2.3	Front-Loading 891930 Chassis with Enhanced Power Supply	1-7
1.3	U.S. and European Chassis Configuration	1-11
2.1	Introduction	2-1
2.2	Voice Modules	2-2
2.2.1	Foreign Exchange Station (FXS) Card (812960)	2-2
2.2.2	Foreign Exchange Office (FXO) Card (813960 and 813970).....	2-3
2.2.3	E&M Card (810860, 811760 & 811960)	2-4
2.2.4	Voice Channel Bank Application	2-5
2.2.5	TR008 Application	2-5
2.2.6	T1-E1 Conversion Application.....	2-6
2.3	Data Modules and Applications	2-7
2.3.1	HSU Card (820260, 820360, 821260, 821360, 821460, 821570, 821660).....	2-7
2.3.2	HSU Application Example	2-9
2.3.3	SRU Card (822060).....	2-10
2.3.4	FRAD Card (823160)	2-11
2.3.5	OCU-DP Card (824160, 824660, and 8249)	2-13
2.3.5.1	OCU-DP Card Models	2-13
2.3.6	BRI Card (826X Series)	2-14
2.3.6.1	BRI Card Models	2-16
2.3.7	DSO-DP Card (825460)	2-16
2.3.8	B7R IP Concentrator Card (822860).....	2-17
2.4	ADPCM Voice Compression Server (887160)	2-19
2.4.1	PBX to PBX Trunk Application.....	2-19
2.4.2	Automatic Call Distribution Application	2-20
2.4.3	Wireless Base Station Application	2-21
2.5	ISDN Primary Rate Interface (PRI) Server (884060)	2-22
2.5.1	NFAS (Non-Facility Associated Signaling).....	2-23
2.5.2	Fractional PRI Provisioning	2-24
2.5.3	ISDN Video Conferencing and Video Broadcast.....	2-25
2.5.4	Integrated ISDN Access with SINA.....	2-27
2.5.5	Data Backup and Bandwidth on Demand	2-28
2.5.6	PRI to FXS termination	2-29
2.5.7	Routing Capabilities	2-30
2.5.7.1	Call Routing	2-30
2.5.7.2	Local Routing	2-30
2.5.7.3	Bi-directional Default Routing.....	2-31
2.5.7.4	Alternate routing	2-31
2.5.7.5	DPNSS Trunk Routing.....	2-32

Contents

2.6	Management Channel Concentrator (MCC) Server (881360)	2-32
2.7	Frame Relay Access and Concentration Server	2-35
2.7.1	Frame Relay Switch Port Savings	2-36
2.7.2	Frame Relay and Internet Service Provisioning	2-36
2.7.3	IDSL Service Provisioning	2-37
2.7.4	Grooming and Concentration in Cellular Networks	2-38
2.7.5	Frame Relay Concentration at Hub Sites.....	2-39
2.7.6	Frame Relay Server Specifications.....	2-40
2.8	ATM Server Card (882060)	2-40
2.8.1	Legacy Adaptation to ATM.....	2-42
2.8.2	Interactive Distance Learning/Tele-Medicine	2-43
2.8.3	ATM Server Specifications	2-44
2.9	Routing Server	2-44
2.9.1	Bundled Service Deployment	2-45
2.9.2	Private Intranet Deployment.....	2-46
2.9.3	IP Routing Server Specifications.....	2-46
2.10	Low-Bit Rate Voice Server (830060)	2-47
2.10.1	Call Center Application	2-48
2.10.2	Backhauling Voice Application.....	2-49
2.10.3	Extending Voice Access Application	2-50
3.1	Introduction	3-1
3.2	User-Set Switches and Jumpers	3-1
3.3	Chassis Installation	3-1
3.3.1	Unpacking the Chassis and Cards.....	3-1
3.3.2	Pre-Installation Tips.....	3-2
3.3.2.1	Installation Checklist	3-2
3.3.3	Choosing a Location for Your System	3-3
3.3.3.1	Rack Installation Tips	3-3
3.3.3.2	Wall-Mount Installation Tips	3-4
3.3.3.3	Tabletop Installation Tips.....	3-4
3.3.4	Installing the Chassis	3-4
3.3.4.1	Front-Loading Chassis with Power Supplies on Side	3-4
3.3.4.2	Front-Loading Chassis with Power Supplies on Top	3-6
3.3.4.3	Two-Sided Chassis	3-7
3.4	Power Supplies and Ringing Generators	3-8
3.4.1	System Power (Redundancy).....	3-8
3.4.2	-48V Talk Battery Requirements.....	3-8
3.4.3	Setting the U.S./European Configuration Jumper	3-9
3.4.4	Installing the System Power Cards	3-9
3.4.5	Talk Battery Supply Fuses.....	3-9
3.4.6	AC Power Supply and DC Power Supply Fuses	3-10
3.4.7	Installing AC or DC Power Supplies.....	3-10
3.4.8	Installing the -48V Converters (8903/8905/8908).....	3-10
3.5	Ringing Generators	3-11
3.5.1	Ringing Generators (8906/890620)	3-12
3.5.2	Installing the 105V Ringing Generator (8906/890620).....	3-12
3.6	System Power and Ground Connections	3-14
3.6.1	Front-Loading Chassis with Power Supplies on the Side (891630)	3-14

3.6.2	Two-Sided Chassis (891830)	3-17
3.6.3	Power Enhanced Chassis with Power Supplies in Front (891930)	3-20
3.7	Powering Up the System	3-23
3.8	Installing the Other Plug-In Cards	3-23
3.8.1	Interface Cards (892260 / 892360 / 892460).....	3-23
3.8.2	CPU Card (880360).....	3-24
3.8.3	WAN Cards (800060 / 801060 / 801160 / 801460 / 801560 / 802060)...	3-24
3.8.4	Server Cards	3-24
3.8.5	User Cards	3-25
3.8.6	Connecting Cables to the Cards	3-25
4.1	Basic Operations	4-1
4.2	Basic Screen Map and Legend	4-1
4.3	System Initialization	4-1
4.3.1	Registration.....	4-1
4.3.2	Logging Into the System	4-6
4.4	System Screens	4-10
4.4.1	System Main Screen	4-10
4.4.2	CPU Card Status.....	4-11
4.4.3	Power Supplies and Ringing Generators Card Status	4-11
4.4.4	Voice and Data Card Status.....	4-11
4.4.5	Server Card Status	4-12
4.4.5.1	FRS Card	4-12
4.4.5.2	MCC Card	4-13
4.4.5.3	ATM Card	4-13
4.4.6	Card Main Screens	4-13
4.4.7	Test and Debug Screen.....	4-15
4.4.8	Time Slot Configuration and Cross-Connect Screens.....	4-15
4.5	Card Configuration	4-15
4.5.1	Selecting and Configuring Your Cards	4-15
4.5.2	Recording Your Configuration Settings.....	4-16
4.6	Reinitializing the System	4-16
4.7	Alarms	4-19
4.7.1	Alarm Screens	4-19
4.7.2	Alarm Filter Settings	4-20
4.7.3	Alarm Modifiers	4-22
4.7.4	Alarm Cutoff (ACO)	4-23
4.7.5	Backplane Out of Service (BP_OOS)	4-23
4.7.6	Alarm Handling.....	4-24
4.8	Time Slot Configuration Screen	4-25
4.9	Deleting an Out of Service Card	4-25
4.10	Accepting New Card Settings	4-25
4.11	Cross-Connecting (XCON)	4-25
4.12	System Level Maintenance	4-25
4.12.1	Test, Debug, Backup & Restore	4-26
4.12.2	Zipping the System.....	4-26
4.12.3	Debugging the System.....	4-27
4.12.4	Registering the System	4-27
4.12.5	Pre-TFTP Backup and Restore Preparation	4-28

Contents

4.12.6	TFTP Backup for 5.x.x	4-28
4.12.7	TFTP Restore for 5.x.x	4-29
4.12.8	ASCII Backup Procedure.....	4-30
4.12.9	ASCII Restore Procedure.....	4-30
4.12.10	XMODEM 128k and XMODEM 1k Backup	4-31
4.12.11	XMODEM 128k and XMODEM 1k Restore	4-32
4.13	Taking a Card Out of Service	4-33
4.14	CPU Switching	4-33
4.15	Time Slot Assignment	4-33
4.15.1	Modes of Operation	4-34
4.15.1.1	XCON Mode (XCON).....	4-34
4.16	Assigning Time Slots	4-34
4.16.1	Assigning a Time Slot to a User Card Port.....	4-34
4.16.2	Assigning Multiple Time Slots to a Port	4-35
4.16.3	Cross-Connect Model	4-37
4.17	Automatic Time Slot Assignment	4-37
4.18	Cross-Connecting WAN Time Slots	4-42
4.19	Cross-Connect Actions	4-57
4.20	Testing Voice Cross-Connects	4-59
4.21	Using the Broadcast Option	4-64
4.21.1	WAN Link to WAN Link	4-70
4.21.2	Broadcast Screen Actions	4-70
4.21.3	Test Access Digroups (TADS)	4-71
4.21.4	Monitor Circuit	4-72
4.21.5	Split Circuit.....	4-75
4.21.6	Release	4-77
4.21.7	Terminate and Leave Access	4-77
4.22	Checking the Time Slot Map	4-79
4.23	Recording the Time Slot Configuration	4-80
4.24	Redundant Operations	4-82
4.25	Power Supply Redundancy	4-82
4.26	CPU Card Redundancy	4-83
4.27	WAN Card Redundancy	4-85
4.27.1	Cross-Connect WAN Card Redundancy Switching	4-86
4.28	ADPCM Card Redundancy	4-89
5.1	Introduction	5-1
5.2	CPU Card Descriptions	5-1
5.2.1	CPU XCON (880360).....	5-1
5.2.1.1	Card Jumper/Switch Settings.....	5-1
5.2.1.2	Installing the CPU XCON Card	5-2
5.3	CPU Card User Screens and Settings	5-2
5.3.1	CPU Card Main Screen.....	5-3
5.3.1.1	Changing Your Passwords.....	5-4
5.3.1.2	Other CPU Card Settings.....	5-4
5.3.2	Printing Alarms Remotely	5-6
5.4	TCP/IP Network Management	5-10
5.4.1	Network Statistics Screens.....	5-16
5.4.1.1	SLIP Parameters	5-18

5.4.1.2	FDL Parameters.....	5-19
5.4.1.3	IP Parameters.....	5-20
5.4.1.4	ICMP Parameters	5-21
5.4.1.5	TCP State Parameters.....	5-22
5.4.1.6	UDP Parameters	5-25
5.4.1.7	TELNET Parameters	5-26
5.4.1.8	SNMP Parameters	5-28
5.5	IP Packet Routing	5-28
5.5.1	nX64 Screen	5-34
5.5.2	Network Statistics Screen.....	5-37
5.6	CPU Host Software Upgrade Procedure	5-38
5.6.1	Equipment Requirements	5-38
5.6.2	Laptop Setup.....	5-38
5.6.2.1	Log Upgrade Activity.....	5-39
5.6.3	Upgrade Preparation	5-39
5.6.3.1	Upgrade from 5.0.0 to 5.1.4	5-40
5.6.3.2	Upgrade from 5.0.1 or greater.....	5-40
5.7	Software Download Procedures	5-40
5.7.1	CPU Swap	5-40
5.7.2	XMODEM Protocol Binary Download.....	5-40
5.7.3	Pre-TFTP Binary Upload/Download Preparation	5-41
5.7.3.1	TFTP or TFTPd Protocol Bin Download	5-42
5.8	CPU Card Error Messages	5-43
5.9	CPU Card Troubleshooting	5-43
5.10	CPU Card Specifications	5-44
6.1	Introduction	6-1
6.2	Interface Card Descriptions	6-1
6.2.1	INF-E Card Description (892261).....	6-1
6.2.1.1	Card Jumper/Switch Settings	6-2
6.2.1.2	Installing the INF-E Card.....	6-2
6.2.1.3	External Sync Panel (1500).....	6-2
6.2.1.4	External Sync Panel for Two-Sided Chassis (1500).....	6-3
6.2.1.5	Sync Panel for Two-Sided Chassis (1500).....	6-4
6.2.1.6	Equipment Grounding Requirements.....	6-6
6.2.2	INF+M Card Description (892360).....	6-7
6.2.2.1	Card Jumper/Switch Settings	6-7
6.2.2.2	Installing the INF+M Card.....	6-7
6.2.3	INF Card Description (892460).....	6-8
6.2.3.1	Card Jumper/Switch Settings	6-8
6.2.3.2	Installing the INF Card.....	6-8
6.3	Interface Card User Screens and Settings	6-9
6.3.1	Interface Card Main Screen.....	6-9
6.3.1.1	Setting the System Date and Time	6-10
6.3.1.2	Selecting the System Timing Clocks	6-11
6.3.2	Call Profile Screen.....	6-14
6.3.3	Signaling Conversion Table Screen	6-19
6.3.4	Remote IMACS Terminal System (RITS).....	6-20
6.3.4.1	Identification	6-20

Contents

6.3.4.2	Network Priorities.....	6-21
6.3.4.3	Intra-Network Communications	6-21
6.3.4.4	Terminal Security	6-22
6.3.5	Ports Screen	6-23
6.3.6	Interface Card Ports and Functionality	6-25
6.3.7	Using the Node Port.....	6-26
6.4	Interface Card Error Messages	6-27
6.5	Interface Card Troubleshooting	6-27
6.5.1	User Interface Problems.....	6-27
6.5.2	Alarm Reporting Problems	6-28
6.5.3	WAN Transmission Problems	6-28
6.6	Interface Card Specifications	6-29
7.1	Introduction	7-1
7.2	WAN Card Descriptions	7-1
7.2.1	WAN SINGLE Card Description (800060).....	7-1
7.2.1.1	Card Jumper/Switch Settings.....	7-1
7.2.2	WAN DUAL Card Description (801060).....	7-2
7.2.2.1	Card Jumper/Switch Settings.....	7-2
7.2.3	WAN-U Card Description (801160).....	7-3
7.2.3.1	Card Jumper/Switch Settings.....	7-3
7.2.4	WAN-R Card Description (801460).....	7-3
7.2.4.1	Card Jumper/Switch Settings.....	7-4
7.2.5	WAN Card with ESF Loopback Description (801560).....	7-4
7.2.5.1	Card Jumper/Switch Settings.....	7-4
7.2.6	WAN HDSL Card Description (802060)	7-4
7.3	WAN Module Descriptions	7-5
7.3.1	DSX/CEPT Module Description (81130).....	7-5
7.3.1.1	DSX/CEPT Module Jumper Settings	7-5
7.3.1.2	DSX/CEPT Module Installation.....	7-5
7.3.1.3	DSX/CEPT Module.....	7-6
7.3.2	CSU Module Description (81230).....	7-9
7.3.2.1	CSU Module Installation	7-9
7.3.2.2	CSU Module Jumper/Switch Settings	7-9
7.3.3	Adtran E1/HDSL Module Description (82030).....	7-9
7.3.3.1	Adtran E1/HDSL Module Installation.....	7-9
7.3.3.2	Adtran E1/HDSL Module Jumper/Switch Settings.....	7-9
7.3.4	PairGain T1/HDSL Module Description (82100)	7-9
7.3.4.1	PairGain T1/HDSL Module Installation.....	7-10
7.3.4.2	PairGain T1/HDSL Module Jumper/Switch Settings.....	7-10
7.3.5	Installing the WAN Cards.....	7-11
7.4	WAN Card User Screens and Settings	7-12
7.4.1	T1 CSU and DSX Settings.....	7-12
7.4.2	E1 CEPT/HDSL Settings.....	7-21
7.4.3	WAN HDSL Card Main Screen	7-25
7.4.4	Cross-Connect (XCON).....	7-33
7.4.5	Performance Data	7-34
7.4.6	Far-End Performance Data	7-37
7.4.7	Test Screen.....	7-39

7.4.8	Adtran E1/HDSL Screen	7-42
7.4.9	Adtran E1/HDSL Performance Data	7-44
7.4.10	PairGain T1/HDSL Screen	7-47
7.5	PARS Screen	7-52
7.5.1	Implementation of PARS	7-55
7.5.2	Ring Network Traffic Flow	7-56
7.5.3	One Link is Lost	7-57
7.5.4	Two Links are Lost, One IAD is Isolated from the Ring	7-58
7.5.5	Two Links are Lost, Two IADs are Separated from the Ring	7-59
7.5.6	Integrated Access Device Functionality	7-60
7.5.7	Normal Operation - No Link Failure	7-60
7.5.8	Line Protection - Link Failure	7-62
7.6	WAN Card Error Messages	7-64
7.7	WAN Card Troubleshooting	7-64
7.8	WAN Card Specifications	7-65
8.1	Introduction	8-1
8.2	Integral Test Capabilities	8-1
8.3	User Card Diagnostics	8-2
8.3.1	WAN Diagnostics	8-2
8.3.2	Voice Diagnostics	8-3
8.3.3	Data Diagnostics	8-4
8.4	System with Cross-Connect Option	8-6
8.4.1	Circuit Diagnostics	8-6
8.5	Benefits of Built-In Diagnostics	8-8
8.6	Performance Monitoring	8-11
8.6.1	T1 Line Performance Monitoring	8-11
8.6.2	DDS Line Performance Monitoring	8-11
8.6.3	Frame Relay Performance Monitoring	8-12
8.6.4	ATM Performance Monitoring	8-12
A.1	Introduction	A-1
A.2	Standards Compatibility	A-2
A.3	Chassis Standards	A-8
A.3.1	Dimensions	A-8
A.3.2	Chassis Power	A-9
A.3.3	Environment	A-9
A.3.3.1	Ambient Temperature and Humidity	A-9
A.3.3.2	Altitude	A-9
A.3.3.3	Airflow	A-10
A.3.3.4	Fire Resistance	A-10
A.3.4	Equipment Handling	A-10
A.3.4.1	Packaged Equipment Shock Criteria	A-10
A.3.4.2	Unpackaged Equipment Shock Criteria	A-10
A.3.5	Earthquake, Office Vibration and Transportation Vibration	A-10
A.3.5.1	Earthquake	A-10
A.3.5.2	Office Vibration	A-10
A.3.5.3	Transportation Vibration	A-10
A.3.6	Cable/Power Connections	A-11
A.3.7	Mounting	A-11

Contents

A.3.7.1	Types	A-11
A.3.7.2	Clearance	A-11
A.3.8	Number of Slots	A-12
A.4	System Power Supplies and Converters	A-13
A.4.1	Power Supply Compatibility	A-15
A.4.2	External Talk Battery Fuses.....	A-15
A.5	Card Specifications	A-16
A.5.1	Dimensions and Power Consumption.....	A-16
A.5.2	Card Current Measurements	A-18
A.5.3	Pre-Installation Card Setup.....	A-19
A.6	Part Number / Acronym Table	A-20
A.7	FCC Requirements	A-21
A.8	UK Requirements	A-22
A.9	Year 2000 Compliance	A-22
B.1	Introduction	B-1
C.1	Introduction	C-1
C.2	Interface Cards	C-2
C.2.1	INF-E Card (892260).....	C-2
C.2.1.1	INF-E Card External Connector and Pinouts	C-2
C.2.2	INF+M Card (892360).....	C-10
C.2.2.1	INF+M Card External Connector and Pinouts	C-10
C.2.3	INF Card (892460).....	C-17
C.2.3.1	INF Card External Connector and Pinouts	C-17
C.3	Alarm Cards	C-20
C.3.1	ALR 4+4 Card (8401840160).....	C-20
C.3.1.1	ALR 4+4 Card External Connectors and Pinouts.....	C-20
C.3.2	ALR 4+3PF Card (8402608402)	C-21
C.3.2.1	ALR 4+3PF Card External Connectors and Pinouts	C-21
C.3.3	ALR 28+14 Card (8403608403).....	C-22
C.3.3.1	ALR 28+14 Card External Connectors and Pinouts.....	C-22
C.4	HSU Cards	C-26
C.4.1	Two-Port HSU530/35 Card (820260)8202.....	C-26
C.4.1.1	Two-Port HSU Card External Connectors and Pinouts.....	C-26
C.4.2	HSU-T V11 Card (8203608203)	C-28
C.4.2.1	HSU-T V11 Card External Connectors and Pinouts	C-28
C.4.3	HSU 35 Card (8212821260).....	C-30
C.4.3.1	HSU 35 Card External Connectors and Pinouts.....	C-30
C.4.4	HSU-AD 530/35 Card (8213608213).....	C-31
C.4.4.1	HSU-AD 530/35 Card External Connectors and Pinouts.....	C-31
C.4.5	HSU-T V35 Card (8214821460)	C-34
C.4.5.1	HSU-T V35 Card External Connectors and Pinouts	C-34
C.4.6	Four-Port HSU 530/35 Card (8215608215/821570)	C-36
C.4.6.1	Four-Port HSU 530/35 Card External Connectors and Pinouts	C-36
C.4.7	Four-Port HSU*4E 530/35 SS Card (821660)	C-38
C.4.7.1	External Connectors and Pinouts.....	C-38
C.4.8	HSU Card Cables.....	C-40
C.5	SRU Cards	C-42
C.5.1	SRU 232*10 Card (8220608220)	C-42

C.5.1.1	SRU 232*10 Card External Connector and Pinouts	C-42
C.5.2	SRU 232*10 C&D Bus Card (8221608220)	C-44
C.5.2.1	SRU 232*10 C&D Bus Card External Connector and Pinouts	C-44
C.6	OCU-DP Cards	C-46
C.6.1	OCU-DP 2 Card (82498249)	C-46
C.6.1.1	OCU-DP 2 Card External Connectors and Pinouts	C-46
C.6.2	OCU-DP 5 Card (8241824160)	C-48
C.6.2.1	OCU-DP 5 Card External Connectors and Pinouts	C-48
C.6.3	OCU-DP 10 Card (8246608246)	C-50
C.6.3.1	OCU-DP 10 Card External Connectors and Pinouts	C-50
C.7	FRAD Cards	C-52
C.7.1	FRAD 232*10 Card (8231608231)	C-52
C.7.1.1	FRAD 232*10 Card External Connectors and Pinouts	C-52
C.8	DS0-DP Cards	C-54
C.8.1	DS0-DP 4 Card (8254825460)	C-54
C.8.1.1	DS0-DP 4 Card External Connector and Pinouts	C-54
C.9	B7R Cards	C-56
C.9.1	B7R Card (822860)	C-56
C.9.1.1	B7R Card External Connector and Pinouts	C-56
C.10	BRI Cards	C-58
C.10.1	BRI U*8 Card (8260826070)	C-58
C.10.1.1	BRI U*8 Card External Connectors and Pinouts	C-58
C.10.2	BRI-SC U*8 Card (826171)	C-59
C.10.2.1	BRI-SC U*8 Card External Connectors and Pinouts	C-59
C.10.3	BRI-ST*8 Card (8262826270)	C-60
C.10.3.1	BRI-ST*8 Card External Connectors and Pinouts	C-60
C.10.4	PM-IOR Card (828060)	C-62
C.10.4.1	PM-IOR Card External Connectors and Pinouts	C-62
C.11	Server Cards	C-64
C.11.1	ACS-MCC Server Card (881360)	C-64
C.11.1.1	ACS-MCC External Connectors and Pinouts	C-64
C.11.2	ACS-ATM Card (882060)	C-65
C.11.2.1	Card External Connectors and Signal Pinouts	C-65
C.11.3	ACS-PRI/BRI Card (881162)	C-66
C.11.3.1	ACS-PRI/BRI Card External Connectors and Pinouts	C-66
C.11.4	IPR 10BT Card (883160)	C-67
C.11.4.1	IPR 10BT Card External Connectors and Pinouts	C-67
C.12	E&M Cards	C-68
C.12.1	E&M 2W*8 Card (8108608108)	C-68
C.12.1.1	E&M 2W*8 Card External Connectors and Pinouts	C-68
C.12.2	E&M 4W*8ER Card (8119811960)	C-70
C.12.2.1	E&M 4W*8ER Card External Connectors and Pinouts	C-70
C.12.3	E&M 4W*8-2713Hz Card (8117608117)	C-72
C.12.3.1	E&M 4W*8-2713Hz Card External Connectors and Pinouts	C-72
C.13	FXS Cards	C-74
C.13.1	FXS 2W*4-6 Card (81258125)	C-74
C.13.1.1	FXS 2W*4-6 Card External Connectors and Pinouts	C-74
C.13.2	FXS 2W*8-6 Card (8129821960)	C-75

Contents

C.13.2.1	FXS 2W*8-6 Card External Connectors and Pinouts	C-75
C.14	FXO Cards	C-76
C.14.1	FXO 2W*8-6 Card (8139813960/813970).....	C-76
C.14.1.1	FXO 2W*8-6 Card External Connector and Pinouts	C-76
C.14.2	FXS Coin Card (814960).....	C-77
C.14.2.1	Card External Connectors and Pinouts	C-77
C.14.3	FXO Coin Card (815960)	C-78
C.14.3.1	Card External Connector and Pinouts	C-78
C.15	P-Phone Cards	C-79
C.15.1	P-Phone Cards PPO (813160) PPS (812160)	C-79
C.15.1.1	P-Phone External Card Connectors and Pinouts	C-79

Figures

1-1	Front-Loading 891630 Chassis with Power Supplies on the Side.....	1-2
1-2	Two-Sided Chassis Front View (891830)	1-4
1-3	Rear View of Two-Sided 891830 Chassis.....	1-5
1-4	Power Enhanced Chassis (891930).....	1-7
1-5	External Power Source for the Power Enhanced Chassis (891930)	1-8
1-6	Power Supply and Ringer Supports for Power Enhanced Chassis (891930)	1-9
2-1	An IAD used as a Voice Channel Bank.....	2-5
2-2	IAD using TR008.....	2-6
2-3	IAD using T1/E1 Conversion	2-7
2-4	Point to MultiPoint One-Way Video and Audio using HSUs	2-10
2-5	IAD with SRU Card Application.....	2-11
2-6	IAD FRAD Card Application	2-12
2-7	BRI Terminal Extension Application	2-15
2-8	BRI Card in a Leased Line or IDSL Application	2-16
2-9	B7R Card used for Network Management (822860).....	2-18
2-10	IAD using ADPCM for PBX to PBX Application	2-20
2-11	IAD in an ISDN-based ACD System	2-21
2-12	IAD in a Wireless Base Station Application	2-22
2-13	Fractional PRI Provisioning using an IAD	2-25
2-14	Video Conferencing System and PBX Sharing a PRI Line.....	2-25
2-15	IAD in Video Broadcast Applications	2-27
2-16	IAD using SINA for ISDN and Leased Line Traffic.....	2-28
2-17	IAD using a PRI Server Card for Data Backup.....	2-29
2-18	PRI to FXS Termination.....	2-29
2-19	Bi-Directional Default Routing	2-31
2-20	Alternate Routing.....	2-32
2-21	MCC Card in a Multilevel Concentration Application.....	2-34
2-22	IAD using Frame Relay Server Cards	2-36
2-23	Frame Relay and Internet Services using IAD FRAD Server	2-37
2-24	IDSL Service Provisioning	2-38
2-25	Cellular Network Frame Relay Application	2-39
2-26	Frame Relay Concentration at Corporate Headquarters	2-40
2-27	Migrating Legacy Networks to ATM	2-43
2-28	Interactive Distance Learning Application	2-44
2-29	IP Routing Server for Internet or Intranet Based Services	2-45
2-30	Private Intranet Deployment using IP Routing Server Card.....	2-46
2-31	LBRV in a Call Center Application.....	2-49
2-32	Backhauling Voice Application.....	2-50
2-33	LBRV Voice Access Application	2-51
3-1	Mounting Holes for Front-Loading Chassis with Power Supplies on the Side	3-4
3-2	Mounting Bracket Holes.....	3-5
3-3	Mounting Holes for Front-Loading Chassis with Power Supplies on Top.....	3-6

3-4	Two-Sided Chassis Mounting Holes.....	3-7
3-5	JP1 Jumper Settings	3-9
3-6	-48V Converter Fuse	3-11
3-7	105V Ringing Generator Jumper Setting	3-13
3-8	DC Terminal Block on Front-Loading Chassis with Power Supplies on the Side in a DC Environment 3-15	
3-9	AC Power Connector on Front-Loading Chassis with Power Supplies on the Side in a AC Environment 3-16	
3-10	DC Terminal Block on Two-Sided Chassis with Power Supplies on the Side in a DC Environment 3-18	
3-11	AC Power Connector on Two-Sided Chassis with Power Supplies on the Side in a AC Environment 3-19	
3-12	DC Terminal Block on Enhanced Chassis with Power Supplies on Top in a DC Environment with one Power Source3-21	
3-13	Power Enhanced Chassis with Power Supplies on Top in an AC Environment with an -48VDC AC/DC Converter for Voice or Data Applications3-22	
4-1	First Time Registration Screen.....	4-2
4-2	First Time Login Screen.....	4-3
4-3	Welcome to Registration Screen	4-4
4-4	Selecting Chassis Type Screen.....	4-5
4-5	Testing and Initialization Screen.....	4-6
4-6	Typical Login Screen	4-8
4-7	Typical System Main Screen (Two-Sided Chassis and Front-Loading Chassis with Power Supplies on Top)4-9	
4-8	Typical System Main Screen (Front-Loading Chassis with Power Supplies on the Side)4-10	
4-9	Typical Card Status Display.....	4-12
4-10	Typical Card Main Screen	4-14
4-11	Cold-Start NVRAM Test Screen.	4-18
4-12	Typical Alarm Screen	4-19
4-13	Alarm Filters Screen	4-20
4-14	Typical Alarm History Screen	4-24
4-15	System Test and Debug Screen.....	4-26
4-16	Zip Screen	4-27
4-17	Typical E&M Card Time Slot Assignments	4-35
4-18	Typical HSU Card Time Slot Assignments for T1	4-36
4-19	Typical HSU Card Time Slot Assignments for E1	4-37
4-20	Automatic Time Slot Assignment Example.....	4-38
4-21	Typical Card Slot and Type Selection	4-39
4-22	Typical WAN Card Selection	4-40
4-23	Typical System Main Screen with Alarms.....	4-41
4-24	Typical WAN Time Slot Assignment Screen	4-42
4-25	Typical CPU Cross-Connect Screen	4-43
4-26	Add a Cross-Connect Circuit Screen	4-44
4-27	New Circuit Selection and ID Assignment	4-46
4-28	WAN Unit Options	4-47
4-29	Time Slot and Bandwidth Options	4-48
4-30	Test Options	4-49
4-31	Cross-Connect Circuit Type Selection.....	4-51

4-32	Trunk Conditioning Option Selection.....	4-52
4-33	Signaling Bit Pattern Selection	4-53
4-34	Voice Options Screen	4-54
4-35	Selecting PCM Conversion.....	4-55
4-36	Selecting Signaling Conversion.....	4-56
4-37	Typical Completed Circuits	4-57
4-38	Updated WAN Card Screen.....	4-58
4-39	Delete Cross-Connection Screen	4-59
4-40	Typical Message on a CPU Cross-Connect Screen	4-60
4-41	Highlighted Circuit on a WAN Cross-Connect Screen	4-61
4-42	Typical Test Screen and ABCD Bit Options	4-62
4-43	Voice Test Diagram	4-63
4-44	Typical Main Cross-Connect Screen	4-65
4-45	Typical All Circuits Screen.....	4-66
4-46	Typical Add Broadcast Screen	4-67
4-47	Typical "To" Destination Selection	4-68
4-48	Typical Time Slot Selection	4-68
4-49	Typical Complete Broadcast Circuit.....	4-69
4-50	Three Broadcast Circuits	4-69
4-51	Typical Deleted Broadcast Circuit.....	4-70
4-52	The TADS screen.....	4-72
4-53	The Add Monitor Circuit Screen	4-73
4-54	Completed Monitor Circuit.....	4-74
4-55	Monitor Circuit Diagram	4-75
4-56	TADS Screen with Split Circuits.....	4-76
4-57	Split Circuit Diagram.....	4-76
4-58	TADS Restore Circuit Screen.....	4-77
4-59	TLA Circuit State Screen.....	4-78
4-60	Typical Time Slot Screen for T1 Operation	4-79
4-61	Typical Time Slot Screen in E1 Operation.....	4-80
4-62	Typical Redundant-Power Supply System Main Screen	4-83
4-63	Manually Switching to a Redundant CPU	4-84
4-64	Typical System with CPU Switchover Completed.....	4-85
4-65	Typical Cross-Connect System with WAN Card Redundancy	4-87
4-66	Switching to a Redundant Cross-Connect WAN Card.....	4-88
4-67	Typical Cross-Connect WAN Card Redundancy Switch in Progress	4-88
4-68	Typical System with Redundant ADPCM Cards	4-89
4-69	Typical ADPCM Card Main Screen	4-90
4-70	Typical ADPCM Card Redundancy Switch in Progress	4-91
5-1	CPU XCON US/EURO Jumper Settings.....	5-2
5-2	CPU Card Main Screen.....	5-3
5-3	Typical CPU Print Alarm Screen.....	5-7
5-4	Typical Alarm Printout	5-10
5-5	Typical TCP/IP Network Management System.....	5-11
5-6	Typical TCP/IP Screen	5-12
5-7	CPU Default IP Port Selection Screen.....	5-14
5-8	CPU Default IP Unit Selection Screen	5-15
5-9	Typical Network Statistics Screen, Page 1	5-17

5-10	Typical Network Statistics Screen, Page 2	5-20
5-11	Typical Network Statistics Screen, Page 3	5-23
5-12	Typical Network Statistics Screen, Page 4	5-26
5-13	Typical Routing Diagram.....	5-29
5-14	Typical IP Routing Screen	5-30
5-15	Routing Address Entry Screen	5-32
5-16	Slot/Unit Options Screen.....	5-33
5-17	IP Static Routing Information Screen	5-34
5-18	nX64 Main Screen.....	5-35
5-19	nX64 Netstat Screen.....	5-37
6-1	INF-E Interface Card (892260).....	6-2
6-2	Jumper Arrangements for the T1/E1 External Sync Panel	6-3
6-3	Two-Sided Chassis, Back View with External Sync Panel Installed.....	6-4
6-4	External Timing Sync Cover Panel (1500)	6-5
6-5	INF+M Interface Card (892360).....	6-7
6-6	INF Interface Card (892460).....	6-8
6-7	Typical Interface Card Main Screen	6-9
6-8	Typical Call Profile Screen	6-14
6-9	Signaling Conversion Table Screen	6-19
6-10	Typical RITS Configuration	6-21
6-11	Typical Ports Screen (INTF+M)	6-23
6-12	Component Layout for the INF+M T1E1 *8 and INF T1E1 *8 Interface Card	6-25
6-13	Node Port ACO Alarm Interface.....	6-26
7-1	WAN DUAL Card (801060).....	7-2
7-2	WAN-U DUAL Card (801160)	7-3
7-3	Installing DSX/CEPT Modules (8010)	7-6
7-4	DSX/CEPT Module Jumpers (T1) (81130)	7-7
7-5	DSX/CEPT Module Jumpers (E1 75 Ohm) (81130)	7-7
7-6	DSX/CEPT Module Jumpers (E1 120 Ohm) (81130)	7-8
7-7	E1 Interface Adapter Panel (118320 or 1184)	7-8
7-8	WAN HDSL Card with PairGain T1/HDSL Modules.....	7-10
7-9	Installing DSX/CEPT Modules.....	7-11
7-10	WAN Card Main Screen for T1 CSU and DSX	7-12
7-11	Line and Local Loopbacks	7-17
7-12	DS0 Time Slot Loopback.....	7-18
7-13	Using WAN Groups.....	7-20
7-14	WAN Card Main Screen for CEPT/HDSL	7-21
7-15	WAN HDSL Card Main Screen for PairGain T1/HDSL Modules.....	7-26
7-16	E1 Cross-Connect Screen (display only)	7-33
7-17	T1 WAN Cross-Connect Screen (display only).....	7-34
7-18	Typical Performance Data Screen.....	7-35
7-19	Typical Far-End Performance Data Screen.....	7-38
7-20	Typical WAN Card Test Screen	7-40
7-21	Typical Adtran E1/HDSL Screen.....	7-43
7-22	Typical Adtran E1/HDSL Performance Data Screen (local 15-minute interval).....	7-45
7-23	Typical Adtran E1/HDSL Performance Data Screen (remote 24-hour interval).....	7-46
7-24	PairGain T1/HDSL Module Screen	7-48
7-25	System Loopbacks towards Master Module	7-50

7-26	PairGain T1/HDSL System Loopbacks towards Slave Module.....	7-50
7-27	Typical T1 WAN PARS Screen	7-52
7-28	Typical E1 WAN PARS Screen	7-53
7-29	WAN Cross-Connect Screen	7-54
7-30	System (Main) Cross-Connect Screen in PARS MODE.....	7-55
7-31	Ring Network Traffic Flow	7-57
7-32	Traffic Flow when One Link is Lost	7-58
7-33	Traffic Flow when two Links are Lost (One IAD is Isolated).....	7-59
7-34	Traffic Flow when two connected IADs are separated from the Ring	7-60
7-35	PARS Time slot Cross-connection between Primary and Secondary WANs	7-61
7-36	User Card Termination on PARS WAN.....	7-61
7-37	PARS Normal Operation Mode using four IAD Nodes	7-62
7-38	PARS Normal Operation Mode (two nodes).....	7-63
7-39	PARS Rerouting (two nodes)	7-64
8-1	Built-In Diagnostics Example (Diagnostics 1 - 4).....	8-9
8-2	Built-In Diagnostics Example (Diagnostics 4 - 8).....	8-10
C-1	INF-E Card Connectors (892260).....	C-2
C-2	RJ48 (COM2) Jack	C-3
C-3	RJ48 Node Jack	C-4
C-4	RS232 (TERM) Local Interface Jack	C-5
C-5	RS485 External Sync Jack.....	C-6
C-6	Management Connector.....	C-7
C-7	NET Jack.....	C-8
C-8	INF+M Card Jacks (892360)	C-10
C-9	MODEM Jack	C-11
C-10	RJ48 (NODE) Jack	C-12
C-11	RS232 (TERM) Local Interface Jack	C-13
C-12	Management Connector.....	C-14
C-13	NET Jack.....	C-15
C-14	8924 Interface Card Jacks (892460)	C-17
C-15	RJ48 (NODE) Jack	C-18
C-16	RS232 (TERM) Local Interface Jack	C-19
C-17	ALR 4+4 Card Jack	C-20
C-18	ALR 4+3PF Card Jack.....	C-21
C-19	ALR 28+14 Card Jacks (840360)	C-22
C-20	RJ-11 Jack.....	C-25
C-21	Two-Port HSU 530/35 Front Panel Connectors (820260).....	C-26
C-22	Two-Port HSU 530/35 Jack Pin Orientation	C-27
C-23	HSU-T V11 Card Front Panel Connectors (820360).....	C-28
C-24	HSU 35 Card Jack Pin Orientation	C-30
C-25	HSU-AD 530/35 Card Jacks (821360)	C-31
C-26	HSU-AD 530/35 Card Jack Pin Orientation.....	C-32
C-27	HSU-AD 530/35 Card RS-366 Jack Pin Orientation.....	C-33
C-28	HSU-T V35 Card Front Panel Connectors (821460).....	C-34
C-29	HSU-T V35 Card Jack Pin Orientation	C-35
C-30	Four-Port HSU 530/35 Card Jacks (821560).....	C-36
C-31	Four-Port HSU*4E 530/35 SS Card Jacks (821660).....	C-38
C-32	SRU 232*10 Card Jacks (822060).....	C-42

C-33	SRU 232*10 C&D Bus Card Jacks (822160)	C-44
C-34	OCU-DP 2 Card Jacks	C-46
C-35	OCU-DP 5 Card Jacks (842160)	C-48
C-36	OCU-DP 10 Card Jacks (824660)	C-50
C-37	FRAD 232*10 Card Jacks (823160)	C-52
C-38	DS0-DP 4 Card Jacks (825460)	C-54
C-39	B7R Card Jacks (822860)	C-56
C-40	BRI U*8 Card Jack	C-58
C-41	BRI-SC U*8 Card Jack	C-59
C-42	BRI-ST*8 Card Jack	C-60
C-43	RJ-48 Form Factor Card Jacks (828060)	C-62
C-44	ACS-MCC Card Ethernet Port Jack.....	C-64
C-45	ATM LAN Interface Connector Pin Assignment.	C-65
C-46	DS3 connector	C-65
C-47	ACS-PRI/BRI Card Ethernet Port Jack.....	C-66
C-48	IPR 10BT Card Ethernet Port Jack	C-67
C-49	E&M 2W*8 Card Jack	C-68
C-50	E&M 4W*8ER Card Jack	C-70
C-51	E&M 4W*8-2713Hz Card Jack	C-72
C-52	FXS 2W*4-6 Card Jack	C-74
C-53	FXO 2W*8-6 Card Jack	C-76
C-54	FXS Coin Card Jack.....	C-77
C-55	FXO Coin Card Jack	C-78
C-56	P-Phone PPO and PPS Card Tip/Ring Connector.....	C-79

Tables

1-1	Card Slots for Front-Loading 891630 Chassis with Power Supplies on the Side	1-3
1-2	Two-Sided Chassis Card Slots	1-6
1-3	Card Slots for Front-Loading Chassis with Enhanced Power Supplies on Top	1-10
3-1	Minimum Two-Sided Chassis Clearances	3-7
4-1	Default Passwords and Access Level	4-7
4-2	System Main Screen Actions	4-10
4-3	Alarm Filters	4-21
4-4	Time Slot Cross-Connection Options and Defaults	4-44
4-5	CPU Cross-Connect Screen Actions	4-57
4-6	WAN Cross-Connect Test Screen Options	4-62
4-7	Broadcast Screen Actions	4-70
4-8	TLA Circuit State Screen Menu of Actions	4-78
4-9	Time Slot Recording Form for T1 Operation	4-80
4-10	Time Slot Recording Form for E1 Operation	4-81
5-1	CPU Card Main Screen Actions	5-3
5-2	Print Alarm Screen Actions	5-7
5-3	Print Alarm Screen Options and Defaults	5-7
5-4	TCP/IP Screen Actions	5-12
5-5	TCP/IP Screen Options and Defaults	5-12
5-6	Network Statistics Screen Actions	5-17
5-7	Routing Screen Actions	5-30
5-8	Settings for Routing Parameters	5-30
5-9	Slot/Unit Options	5-33
5-10	nX64 Screen Actions	5-35
5-11	nX64 Screen Options and Defaults	5-36
5-12	nx64 Netstat Screen Actions	5-37
6-1	Jumper Settings for the T1/E1 External Sync Panel	6-3
6-2	Interface Card Main Screen Actions	6-10
6-3	Interface Card Setting Options and Defaults	6-11
6-4	Call Profile Screen Actions	6-15
6-5	Call Profile Screen Options and Defaults	6-15
6-6	Signaling Conversion Table Screen Actions	6-20
6-7	“AT” Commands Used by RITS	6-22
6-8	Interface Ports and Functions	6-25
7-1	Symbols Used for Different Modules	7-10
7-2	T1 CSU and DSX Main Screen Actions	7-13
7-3	T1 CSU and DSX Option Settings and Defaults	7-13
7-4	DS0-to-SLC-96 Time Slot Conversion	7-15
7-5	AIS/ALM Settings	7-16
7-6	E1 HDSL Screen Actions	7-22
7-7	E1 HDSL Screen Option Settings and Defaults	7-22
7-8	WAN HDSL Card Main Screen Actions	7-26

7-9	WAN HDSL Card Option Settings and Defaults.....	7-27
7-10	DS0-to-SLC-96 Time Slot Conversion.....	7-28
7-11	AIS/ALM Settings	7-29
7-12	Performance Data Screen Actions	7-35
7-13	Far-End Performance Data Screen Actions	7-38
7-14	Test Screen Actions	7-40
7-15	WAN Card Test Screen Options.....	7-40
7-16	Adtran E1/HDSL Screen Actions	7-43
7-17	Adtran E1/HDSL Screen Options and Defaults.....	7-43
7-18	Adtran E1/HDSL Performance Data Screen Actions	7-46
7-19	PairGain T1/HDSL Module Screen Actions.....	7-48
7-20	PairGain T1/HDSL Module Screen Options and Defaults	7-48
7-21	Available PairGain T1/HDSL Loopbacks	7-49
7-22	T1 WAN PARS Screen Actions	7-52
7-23	WAN Card Test Screen Options.....	7-53
C-1	RJ48 (COM2) Jack Signal Pinouts	C-3
C-2	RJ48 (NODE) Jack Signal Pinouts	C-4
C-3	RS232 (TERM) Jack Signal Pinouts.....	C-5
C-4	RS485 External (SYNC) Jack Signal Pinouts.....	C-6
C-5	Management Connector Signal Pinouts.....	C-7
C-6	NET Jack Signal Pinouts.....	C-9
C-7	Modem Specifications.....	C-11
C-8	RJ48 (NODE) Jack Signal Pinouts	C-12
C-9	RS232 (TERM) Jack Signal Pinouts.....	C-13
C-10	Management Connector Signal Pinouts.....	C-14
C-11	NET Jack Signal Pinouts.....	C-16
C-12	RJ48 (NODE) Jack Signal Pinouts	C-19
C-13	RS232 (TERM) Jack Signal Pinouts.....	C-19
C-14	ALR 4+4 Card Jack Pinouts	C-20
C-15	ALR 4+3PF Card Jack Pinouts	C-21
C-16	ALR 28+14 Card Alarm Sensor Pinouts	C-23
C-17	ALR 28+14 Card Alarm Switch Pinouts	C-24
C-18	RJ-11 Jack Signal Pinouts.....	C-25
C-19	Two-Port HSU 530/35 Jack Pinouts	C-27
C-20	HSU-T V11 Jack Pinouts.....	C-29
C-21	HSU 35 Card Jack Signal Pinouts.....	C-30
C-22	HSU-AD 530/35 Card Jack Signal Pinouts	C-32
C-23	HSU-AD 530/35 Card RS-366 Jack Pinouts	C-33
C-24	HSU-T V35 Card Jack Pinouts	C-35
C-25	Four-Port HSU 530/35 Jack Pinouts.....	C-37
C-26	Four-Port HSU*4E 530/35 SS Jack Pinouts	C-39
C-27	HSU to Cable Matrix (To DTE Clock).....	C-40
C-28	HSU to Cable Matrix (To DCE Clock).....	C-40
C-29	HSU to Cable Matrix (DCE Provides Clock).....	C-41
C-30	SRU 232*10 Card Jack Pinouts	C-43
C-31	SRU 232*10 C&D Bus Card Jack Pinouts	C-45
C-32	OCU-DP 2 Jack Signals Pinouts.....	C-47
C-33	OCU-DP 5 Jack Signals Pinouts.....	C-49

C-34	OCU-DP 10 Jack Signals Pinouts	C-51
C-35	FRAD 232*10 Card Jack Signal Pinouts	C-53
C-36	DS0-DP 4 Card Jack Pinouts	C-55
C-37	B7R Card Jack Signal Pinouts	C-57
C-38	BRI U*8 Card Jack Signal Pinouts	C-58
C-39	BRI-SC U*8 Card Sealing Current Card Jack Signal Pinouts	C-59
C-40	BRI-ST*8 Card Jack Signal Pinouts	C-61
C-41	PM-IOR Card Console Port "CO" Jack Pinouts	C-63
C-42	PM-IOR Card Ethernet Port Jack Pinouts	C-63
C-43	ACS-MCC Card Ethernet Jack Pinouts	C-64
C-44	ATM LAN Interface Port Pin Assignment	C-65
C-45	ACS-PRI/BRI Card Ethernet Jack Pinouts	C-66
C-46	IPR 10BT Card Ethernet Jack Pinouts	C-67
C-47	E&M 2W*8 Card Jack Pinouts	C-69
C-48	E&M 4W*8ER Card Jack Pinouts	C-71
C-49	E&M 4W*8-2713Hz Card Jack Pinouts	C-73
C-50	FXS 2W*4-6 Card Jack Pinouts	C-74
C-51	FXS 2W*8-6 Card Jack Pinouts	C-75
C-52	FXO 2W*8-6 Card Jack Pinouts	C-76
C-53	FXS Coin Card Jack Pinouts	C-77
C-54	FXO Coin Card Jack Pinouts	C-78
C-55	P-Phone PPO and PPS Card Tip/Ring Connector Pinouts	C-80



Chapter 1

System Overview

1.1 Introduction

This chapter describes chassis models used by the Integrated Access System (IAS). It describes each chassis and the card slot locations.

Three series of chassis models are available:

- 891630 Front-loading chassis with power supplies on the side
- 891830 Front and rear-loading chassis with power supplies on the side, or the *two-sided* chassis
- 891930 Front-loading chassis with enhanced power supply

Four basic types of plug-in cards are available:

- Common cards include the CPU card and the Interface card
- User cards include the Voice card, Data card and the Alarm card
- Server cards include the ADPCM, FRS, MCC, ATM, ISDN-PRI, PRI-BRI, IMUX and IPR cards);
- WAN cards for T1 or E1 networks

These chassis are made of steel and have the improved “v” design card guides that protect the electrical traces of all cards from contact with the chassis. All cards slide into slots in front of a front-loading chassis, or into both sides of a two-sided chassis. Card guides on the top and bottom of the chassis slots align the cards with the connectors for easy insertion.

1.2 Chassis Types

1.2.1 Front-Loading Chassis with Power Supplies on the Side (891630)

Figure 1-1 shows a front-loading chassis with the power supplies on the right side. All cable and card access is from the front of the chassis.

This chassis is made of steel and has punched-steel card guides. This chassis is designed for table top, wall or rack mounting.

The 891630 chassis is equipped with two CPU card slots, C1 and C2, and a common bus. The combination slots for this chassis are P1 to P4, and W1 to W4. When used for voice, data, terminal interface, and/or alarm cards, these slots are referred to as slots U1 through U8.

Slot P4 is not supported for a server card. Only user cards can be installed in the P4 slot. Table 1-1 illustrates the suggested mapping for this chassis type. Table 1-1 also lists the card slot locations for the 891630 chassis. Refer to this table when determining your 891630 chassis card configuration.

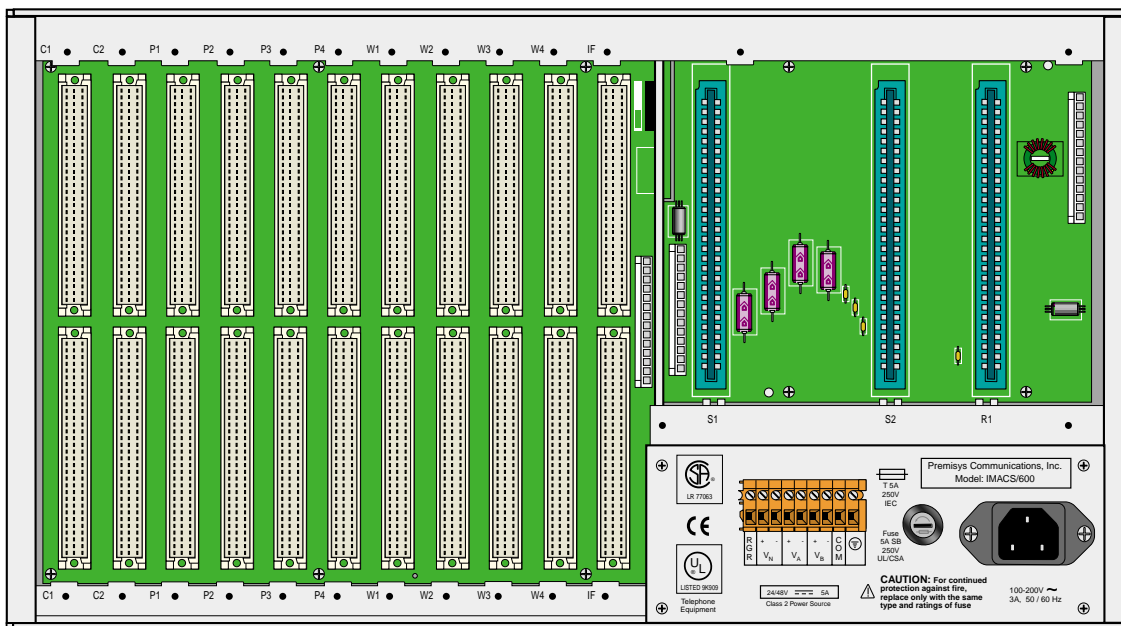

Figure 1-1. Front-Loading 891630 Chassis with Power Supplies on the Side

Table 1-1. Card Slots for Front-Loading 891630 Chassis with Power Supplies on the Side

Type of Card	# of Cards	Slots Used	Notes
CPU	1 or 2	C1, C2	One required in either slot
Server	0 to 3	P1, P2, P3	ADPCM, FRS, MCC, ATM, ISDN-PRI, PRI-BRI, IMUX, and IPR (P4 is not used for Server Cards)
WAN	1 to 4	W1 to W4	One required
Interface	1	IF	Required
Alarm	0 to 7	P1-4, W1-4	Internal/External, any user slot
E&M Voice	0 to 7	P1-4, W1-4	2/4-wire voice, any user slot
FXS Voice	0 to 7	P1-4, W1-4	2-wire voice, any user slot
FXO Voice	0 to 7	P1-4, W1-4	2-wire voice, any user slot
FXS-C Voice	0 to 7	P1-4, W1-4	2-wire voice, coin, any user slot
FXO-C Voice	0 to 7	P1-4, W1-4	2-wire voice, coin, any user slot
PPhone Voice	0 to 7	P1-4, W1-4	PPS and PPO voice cards, any user slot
B7R	0 to 7	P1-4, W1-4	FDL Mux, any user slot
BRI Data	0 to 7	P1-4, W1-4	BRI, any user slot
DS0-DP Data	0 to 7	P1-4, W1-4	The DS0-DP card Contra directional/Codirectional Data Unit (DS0-DP/G.703) provides a 64 kbps interface to a DS0 time slot of a T1 or E1 network. This is a 4-wire data card and inserts into any user card slot.
FRAD Data	0 to 7	P1-4, W1-4	FRAD, any user slot
HSU Data	0 to 7	P1-4, W1-4	High-speed data, any user slot
OCU-DP Data	0 to 7	P1-4, W1-4	The Office Channel Unit - Dataport cards interface directly with Data Service Units/Channel Service Units (DSU/CSUs) support data traffic up to an including 64 kbps. This is a 4-wire data card and inserts into any user card slot.
SRU Data	0 to 7	P1-4, W1-4	Sub-rate data, any user slot
Main Power (AC/DC)	1 or 2	S1 and S2	AC or DC power supplies
Optional Power	0 or 1	S2	AC-to-DC converter (-48V)
Optional Ringer	0 or 1	R1	Ringling generator

1.2.2 Two-Sided 891830 Chassis

Figure 1-2 shows the front of a two-sided chassis. This chassis accepts cards from both the front and rear. It is made of steel and has punched-steel card guides.

The front of the two-sided chassis holds up to two CPU cards, slots C1 and C2, and up to three server cards slots, P1 to P3, and up to four WAN cards slots, W1 to W4. The power supplies occupy slots F1 and F2.

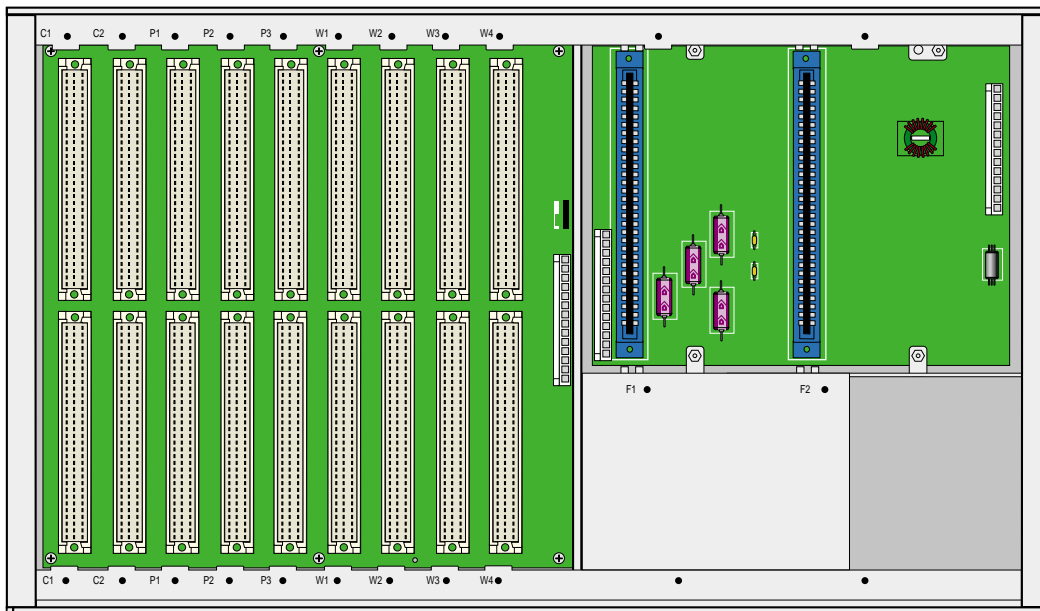

Figure 1-2. Two-Sided Chassis Front View (891830)

This chassis is designed for table-top or rack mounting.

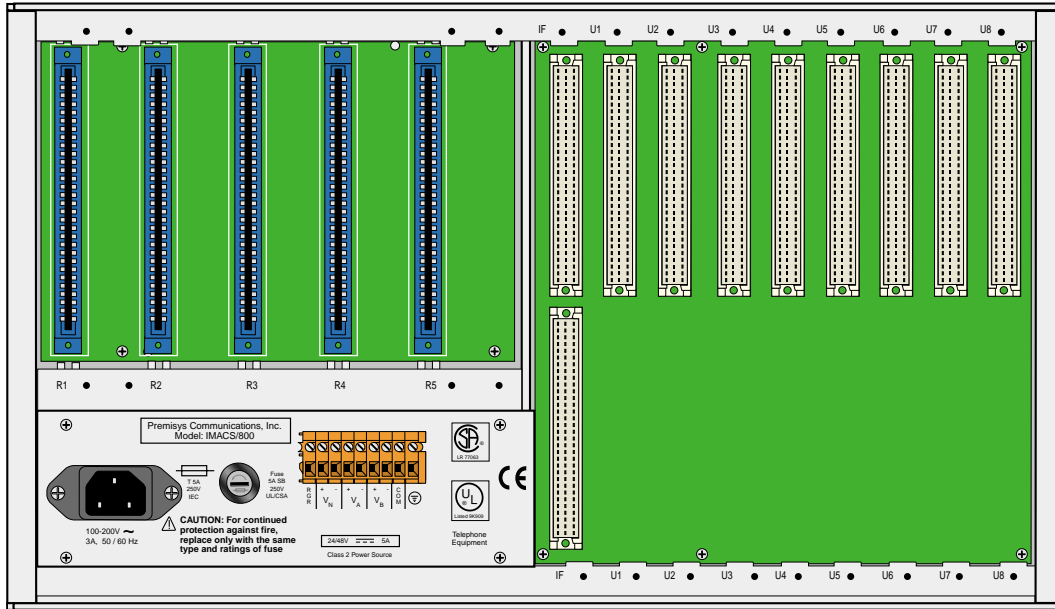

Figure 1-3. Rear View of Two-Sided 891830 Chassis

Figure 1-3 shows the rear of the two-sided chassis. The eight user slots U1 through U8 hold a combination of user cards. The slot labeled IF holds the Interface card.

Slots R1 to R5 hold the optional AC-to-DC power converters and ring generators.

Use Table 1-2 to determine your two-sided chassis card slot configuration.

Table 1-2. Two-Sided Chassis Card Slots

Type of Card	# of Cards	Slots Used	Notes
CPU	1 or 2	C1, C2	One required in either slot
Server	1 to 3	P1, P2, P3	ADPCM, FRS, MCC, ATM, ISDN-PRI, PRI-BRI, IMUX, and IPR (P4 is not used for Server Cards)
WAN	1 to 4	W1-W4	One required
Interface	1	IF	Required
Alarm	0 to 8	U1-U8	Internal/External, any user slot
E&M Voice	0 to 8	U1-U8	2/4-wire voice, any user slot
FXS Voice	0 to 8	U1-U8	2-wire voice, any user slot
FXO Voice	0 to 8	U1-U8	2-wire voice, any user slot
FXS-C Voice	0 to 8	U1-U8	2-wire voice, coin, any user slot
FXO-C Voice	0 to 8	U1-U8	2-wire voice, coin, any user slot
PPhone Voice	0 to 8	U1-U8	PPS and PPO voice cards, any user slot
B7R Data	0 to 8	U1-U8	FDL Mux, any user slot
BRI Data	0 to 8	U1-U8	BRI, any user slot
DS0-DP Data	0 to 8	U1-U8	The DS0-DP card Contra directional/Codirectional Data Unit (DS0-DP/G.703) provides a 64 kbps interface to a DS0 time slot of a T1 or E1 network. This is a 4-wire data card and inserts into any user card slot.
FRAD Data	0 to 8	U1-U8	FRAD, any user slot
HSU Data	0 to 8	U1-U8	High-speed data, any user slot
OCU-DP Data	0 to 8	U1-U8	The Office Channel Unit - Dataport cards interface directly with Data Service Units/Channel Service Units (DSU/CSUs) support data traffic up to an including 64 kbps. This is a 4-wire data card and inserts into any user card slot.
SRU Data	0 to 8	U1-U8	Sub-rate data, any user slot
Main Power (AC/DC)	1 or 2	F1, F2	AC or DC power supplies
Optional Power	0 to 2	R1-R5	AC-to-DC converter (-48V)
Optional Ringer	0 to 5	R1-R5	Ringling generator

1.2.3 Front-Loading 891930 Chassis with Enhanced Power Supply

Figure 1-4 shows the front-loading chassis that uses the 8908 enhanced power converter. This is a tall chassis in which the two power supply slots (P1/P2) are in the upper right.

This chassis is designed for table top, wall or rack mounting. All cable and card access is from the front of the chassis.

Slots P1 to P3 will hold three server cards. Slots W1 to W4 hold four WAN cards. Slots U1 through U8 will hold eight user cards.

Slots P1 and P2 hold up to two power supply models 8901 or 8902. Slots R1 and R2 hold up to a maximum of two ring generators model 890620.

Slots NS1 and NS2 are the two low power slots for the AC-to-DC converters models 8903 and 8905. Slots HP1 and HP2 are for the two high power AC-to-DC converters model 8908.

Note: Cannot mix High/Low Power Converters in the Power Enhanced Power Chassis.

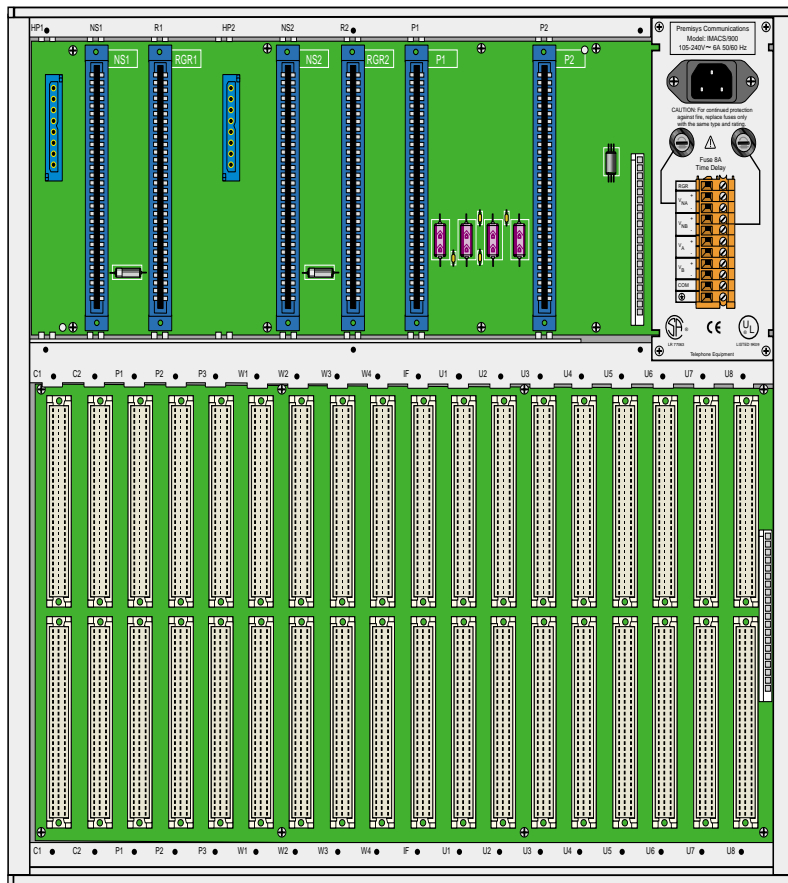

Figure 1-4. Power Enhanced Chassis (891930)

The power enhanced chassis works in a specific environment relating to applications using BRI cards. If your environment requires this type of configuration, notify your system administrator for applications design and configuration setup.

This chassis can accept a total of four power supplies. Two are standard power supplies, and two are load sharing power supplies.

One load sharing power supply is used as a redundant power supply, and the other is used as the primary power supply. See Figure 1-5 for wiring details.

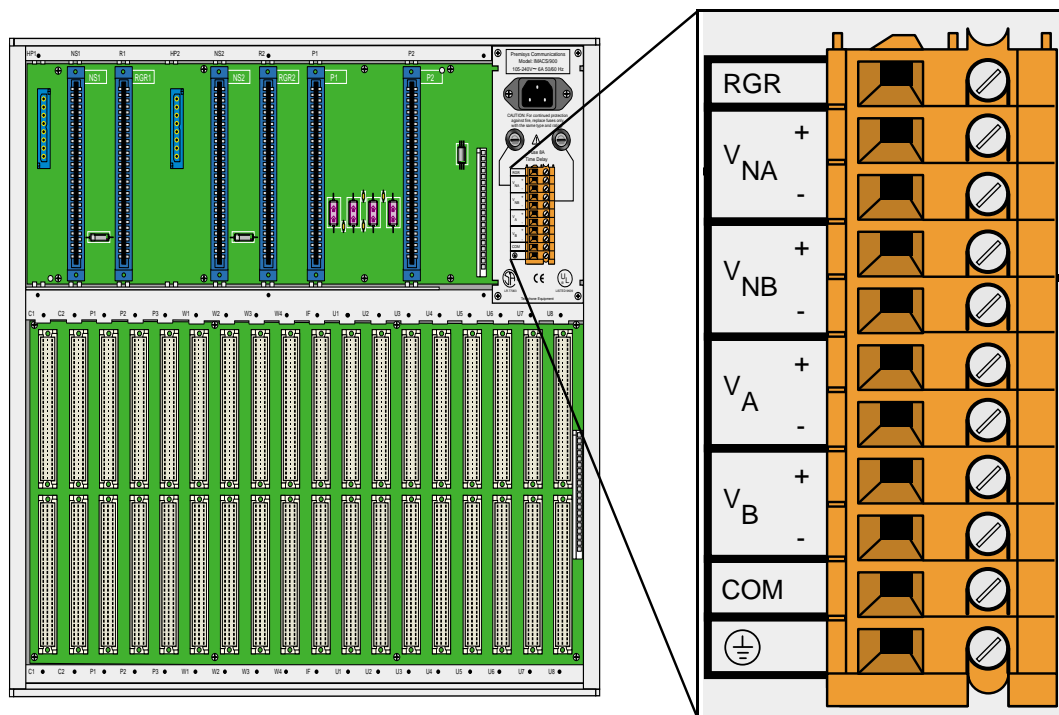

Figure 1-5. External Power Source for the Power Enhanced Chassis (891930)

Notes:

1. V_{NA} (+ & -) are dual -48VDC feeds for the data backplane when -48VDC is to be output from the user card. V_{NA} and V_{NB} are independently protected by 8 amp fuses located on the front panel above the TB connector.
2. V_A (+ & -) and V_B (+ & -) are dual feeds for the power supplies located in slots P1 & P2 respectively (see note 3).
3. Power to V_{NA} (+ & -) and V_{NB} (+ & -) must be supplied by an external -48VDC power source or jumpered from either V_A (+ & -) or V_B (+ & -) if -48VDC power is required on the data backplane.

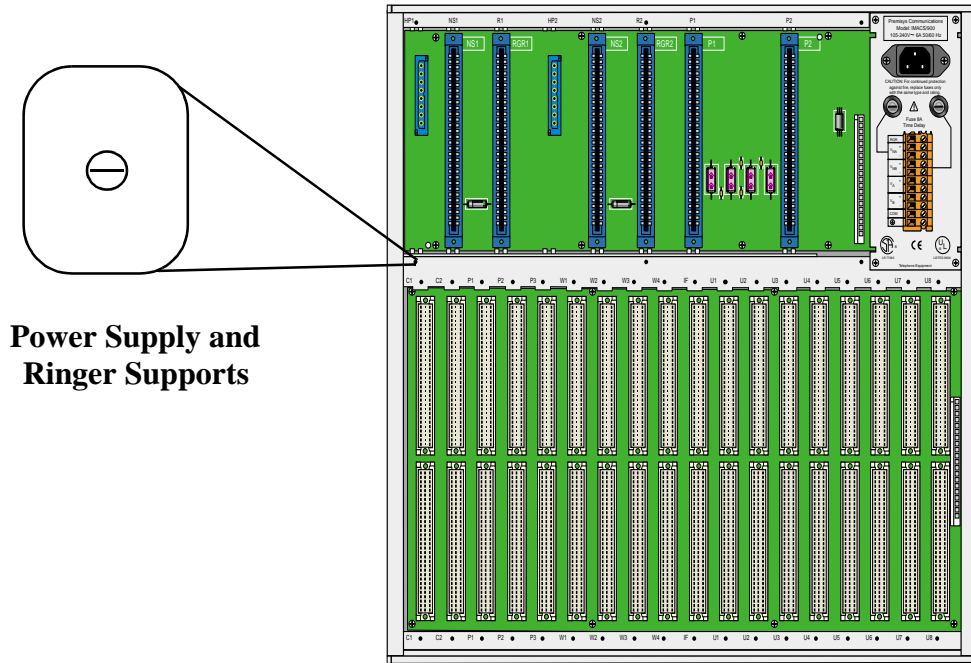

Figure 1-6. Power Supply and Ringer Supports for Power Enhanced Chassis (891930)

A more detailed description of this chassis and its power capabilities is given in chapter 3.

Table 1-3 shows the card slots for the front-loading chassis with the power supplies on top. Use Table 1-3 to determine your chassis card configuration.

Table 1-3. Card Slots for Front-Loading Chassis with Enhanced Power Supplies on Top

Type of Card	# of Cards	Slots Used	Notes
CPU	1 or 2	C1, C2	One required in either slot
Server	1 to 3	P1, P2, P3	ADPCM, FRS, MCC, ATM, ISDN-PRI, PRI-BRI, IMUX, and IPR (P4 is not used for Server Cards)
WAN	1 to 4	W1-W4	One required
Interface	1	IF	Required
Alarm	0 to 8	U1-U8	Internal/External, any user slot
E&M Voice	0 to 8	U1-U8	2/4-wire voice, any user slot
FXS Voice	0 to 8	U1-U8	2-wire voice, any user slot
FXO Voice	0 to 8	U1-U8	2-wire voice, any user slot
FXS-C Voice	0 to 8	U1-U8	2-wire voice, coin, any user slot
FXO-C Voice	0 to 8	U1-U8	2-wire voice, coin, any user slot
B7R Data	0 to 8	U1-U8	FDL Mux, any user slot
BRI Data	0 to 8	U1-U8	BRI, any user slot
PPhone Voice	0 to 7	U1-U8	PPS and PPO voice cards, any user slot
DS0-DP Data	0 to 8	U1-U8	The DS0-DP card Contra directional/Codirectional Data Unit (DS0-DP/G.703) provides a 64 kbps interface to a DS0 time slot of a T1 or E1 network. This is a 4-wire data card and inserts into any user card slot.
FRAD Data	0 to 8	U1-U8	FRAD, any user slot
HSU Data	0 to 8	U1-U8	High-speed data, any user slot
OCU-DP Data	0 to 8	U1-U8	The Office Channel Unit - Dataport cards interface directly with Data Service Units/Channel Service Units (DSU/CSUs) support data traffic up to an including 64 kbps. This is a 4-wire data card and inserts into any user card slot.
SRU Data	0 to 8	U1-U8	Sub-rate data, any user slot
Main Power (AC/DC)	1 or 2	F1, F2	AC or DC power supplies
Optional Power	0 to 2	NS1-NS2	AC-to-DC converter (-48V) 100W
Optional Ringer	0 to 2	R1-R2	Ring generator
Enhanced Power	0 to 2	HP1-HP2	AC-to-DC converter (-48V) 300W

1.3 U.S. and European Chassis Configuration

The chassis can be configured to comply with either U.S. (domestic) or European electrical safety standards by setting a jumper inside each chassis. Refer to *Chapter 3. Installation* for details.

In order to meet the safety requirements of 73/23/EEC, it was necessary to increase the separation of the backplane traces for -12VDC and -48VDC. This was accomplished by creating a second -12VDC trace that has sufficient separation from the -48VDC trace. Newer cards and chassis have been designed with a jumper (CE) to allow the user to select which trace to use. Older cards which are not equipped with the CE jumper require the chassis jumper to be in the US position while newer cards equipped with the CE jumper will work in either position as long as the jumper on the cards and the chassis is in the same position. If there is a mismatch of the cards and chassis, the cards will not power up correctly.

Chapter 2

Applications

2.1 Introduction

By virtue of its open design, this system is capable of serving many different roles within a network. Some of the various functions the system can perform include:

- Cross-Connect Functionality
- Leased Line Provisioning
- ATM Transport
- Frame Relay Transport
- Video Broadcast
- Sub-Rate Data Transport
- Wireless Base Station
- Data Backup and Bandwidth on Demand
- Interactive Distance Learning/Tele-Medicine

Sample application examples are detailed in this chapter. These examples are meant neither to be exhaustive nor definitive, but simply to detail possible applications for this system.

While the system is designed to run multiple simultaneous applications, not all applications can run at the same time on the same chassis, based on conflicting resource allocations and slot requirements. If you are unsure about whether you can run certain applications simultaneously on a single system, consult with your network administrator regarding network design considerations.



Note: *IAD is an example for any type of Integrated Access System used in the field for which these applications can be implemented.*

2.2 Voice Modules

2.2.1 Foreign Exchange Station (FXS) Card (812960)

This Integrated Access System supports one variant of Foreign Exchange Station (FXS) cards:

- 812960 FXS Card provides eight 2-wire analog ports with a terminating impedance of 600 ohms.

FXS cards can be installed in any User Slot in the system chassis. FXS cards encode the incoming analog voice signals into 64 Kbps PCM format before transmission onto the network. Each FXS card provides a single 50-pin female AMPHENOL connector (RJ27X).

All port parameters are software configurable on a port by port basis. The Mode setting specifies whether the port is to be used for standard Foreign Exchange Station, Foreign Exchange Software Defined Network, Private Line Automatic Ringdown (PLAR), or Dial Pulse Origination applications. For example in the case of a PLAR circuit, the port can be programmed to provide Ringback Tone towards the caller. The Type setting specifies Loop Start, Loop Forward, Ground Start, Ground Start Immediate and Ground Start Automatic operation. If the PLAR mode is selected, then the two options supported under Type are "D3" and "D4" which meet the pre-1988 and post-1988 specifications for PLAR circuits. The PCM Coding options supported include μ -Law, A-Law and inverted A-law, and the user may also select the Trunk Conditioning mode (busy or idle) that should be applied towards the attached equipment should the WAN facility that the port is connected to fails. In addition, both the Transmit (Tx) and Receive (Rx) TLP levels can be set in increments of 0.1 dB. The Tx TLP range is from -10.0 dB to +5.0 dB. The Rx TLP range is from -10.0 dB to +2.0 dB.

The user may also specify, on a port-by-port basis, whether to use North American ANSI standard ABCD signaling (which is the default) or ITU (CCITT) ABCD signaling by turning the signaling conversion setting "on" or "off". The trans-hybrid balance may be specified as one of eight values as well as for a customized user-specified terminating impedance. At the present time, all eight values are identical and are set for a terminating impedance of 600_@ 2.15 μ F.

Software-initiated testing and diagnostics supported on FXS cards include the setting of both analog and digital loopback towards the network and the generation of a Digital MilliWatt (DMW) signal on a port-by-port basis. A robust set of test functions allow the user to monitor and set the state of the analog Tip and Ring leads of any FXS port and to set and monitor the state of the ABCD signaling bits of the digitized voice signal. In cross-connect systems, the Test functionality also includes the ability to generate test tones (300Hz, 1 kHz, 3 kHz and "quiet") and transmit those toward either the user side or the network side of the system. FXS cards can use the voice-compression features of the ADPCM and LBRV resource cards.

2.2.2 Foreign Exchange Office (FXO) Card (813960 and 813970)

This Integrated Access System supports one variant of Foreign Exchange Office (FXO) cards:

- 813960/813970 FXO Card provides eight 2-wire analog ports with terminating impedance of 600 ohms. The 813970 is functionally equivalent to the 813960, and improves the ground start circuit.

FXO cards can be installed in any of the User Slots of the system chassis. FXO card encodes the incoming analog voice signals into 64 Kbps PCM format before transmission onto the network.

A Ring Generator is required if one or more FXO ports in a system are programmed to operate in Manual Ringdown (MRD) mode.

In addition, a physical jumper must be set on the FXO card for each port programmed for MRD operation. Each FXO card provides a single 50-pin female AMPHENOL connector (RJ27X).

The MRD mode also requires the setting of physical jumpers. The Signal setting specifies Loop Start, Loop Forward, Ground Start, R2, and Immediate R2 operation. In "fxodn" and "dpt" modes, the user may also specify the wink duration time and wink delay from 0.1 seconds to 9.9 seconds in 0.1 second increments.

All port parameters are software configurable on a port by port basis. The Mode setting specifies whether the port is to be used for standard Foreign Exchange Office, Foreign Exchange Software Defined Network, Dial Pulse Terminate, or Manual Ring Down (MRD).

The PCM Coding options supported include "μ-law", "A-law" and inverted A-law. The user may select the Trunk Conditioning mode ("busy" or "idle") that should be applied towards the attached equipment should the WAN facility that the port is connected to fail. In addition, both the Transmit (Tx) and Receive (Rx) TLP levels can be set in increments of 0.1 dB. The Tx TLP range is from -10.0 dB to +5.0 dB. The Rx TLP range is from -10.0 dB to +2.0 dB.

The user may also specify, on a port-by-port basis, whether to use North American ANSI standard ABCD signaling (which is the default) or ITU (CCITT) ABCD signaling by turning the signaling conversion setting "on" or "off."

The trans-hybrid balance may be specified as one of eight values (known as "set1" through "set8") as well as for a customized user-specified terminating impedance ("user"). All eight values are identical and are set for a terminating impedance of 600_@ 2.15μF in the case of the Model 813960/813970 FXO card.

Software-initiated testing and diagnostics supported on FXO cards include the setting of both analog and digital loop backs towards the network and generating a Digital MilliWatt signal on a port-by-port basis. A robust set of Test functions allow the user to monitor and set the state of the analog Tip and Ring leads of any FXO port.

It also sets and monitors the state of the digitized voice signal's ABCD signaling bits. In cross-connect systems, the Test functionality also includes the ability to generate test tones (300Hz, 1 kHz, 3 kHz and "quiet") and transmit those toward either the user side or the network side of the system.

2.2.3 E&M Card (810860, 811760 & 811960)

This Integrated Access System supports two variants of E&M cards:

- 810860 E&M Card supports eight 2-wire E&M or Transmission Only (TO) ports
- 811960 E&M Card supports eight 4-wire E&M or Transmission Only (TO) ports

The 811960 E&M card offers an extended Transmit TLP range (-17.5 to +14.5dB) to better support dedicated 4-wire modem applications. This may be required in situations when specific types of modems being connected to the ports cannot, or will not, change their output power levels. Modems can only be connected with the E&M when placed in TO mode.

E&M cards can be installed in any of the User Slots of the system chassis. E&M cards encode the incoming analog voice signals into 64 Kbps PCM format before transmission onto the network. Each E&M card provides a single 50-pin female AMPHENOL connector (RJ27X). All three cards support E&M signaling types I, II, IV, and V.

Most port parameters are software configurable on a port by port basis including the Mode of each port ("E&M", "E&MR2" or "TO"). The PCM Coding to be used is either u-law, a-law or a-inv (for inverted a-law). The Trunk Conditioning (busy or idle) is configured on the equipment in case the WAN facility that the port is connected fails.

The user may also specify, on a port-by-port basis, whether to use North American ANSI standard default, ABCD signaling, or ITU (CCITT) ABCD signaling by turning the signaling conversion setting "on" or "off".

For the Model 810860 2-wire E&M card only, the trans-hybrid balance may be specified as one of eight values as well as for a customized user-specified terminating impedance ("user"). All eight values are identical and are set for a terminating impedance of 900_@ 2.15μF.

Software-initiated testing and diagnostics supported on E&M cards include the setting of both analog and digital loop backs towards the network and the generation of a Digital MilliWatt signal on a port-by-port basis. A robust set of test functions allow the user to monitor and set the state of the analog E and M leads of any port and to set and monitor the state of the ABCD signaling bits of the digitized voice signal. In cross-connect systems, the Test functionality also includes the ability to generate test tones (300Hz, 1 kHz, 3 kHz and "quiet") and transmit those toward either the user side or the network side of the system.

2.2.4 Voice Channel Bank Application

This is the simplest application which can be used by a service provider. The Integrated Access System is used in this configuration when one or more digital T1/E1 trunks are needed to interface with analog PBXs or key systems at the customer premises. In the US, the break-even point for bringing in a T1 trunk as opposed to multiple analog lines is typically 6 analog lines. A single Integrated Access System can be used to provision up to 62 analog POTS lines (FXS, FXO, E&M) on digital Central Office switches as shown in Figure 2-1.

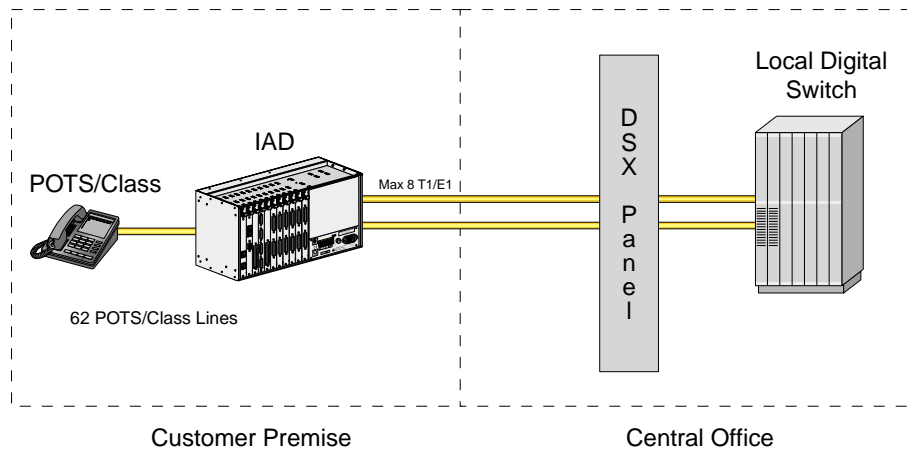

Figure 2-1. An IAD used as a Voice Channel Bank

This Integrated Access System can also be deployed in applications which do just the reverse of voice channel banks. This is most likely to be found in wireless local loop applications in which the wireless service provider may use a state-of-the-art wireless local loop. The output of the wireless base station is normally a T1/E1. However, the existing PSTN may still have analog switches. The Integrated Access System is used to convert from robbed-bit signaling/CAS to analog trunks.

The voice channel bank platform can be upgraded to provide an array of additional services just by adding application modules to the chassis. It comes with a built-in suite of testing and diagnostics tools which enhance the service and support capabilities significantly.

2.2.5 TR008 Application

BellCore's TR-TSY-000008 standard describes the requirements necessary for a Local Digital Switch (LDS) to connect to a remote terminal (RT) across a T1 (1.544Mbps) digital interface. The standard allows supporting from one to four T1s per RT without facility Automatic Protection Switching (APS), and three to five T1s with facility APS.

The LDS can interface the RT in Mode I (no concentration), Mode II (2:1 concentration), and Mode III (24 special-service circuits on 24 DS1 time-slots). TR008 supports traditional POTS, CLASS, and Coin services but does not support ISDN BRI.

If the service provider deploys a channel bank at the customer premise that does not provide TR008 capability then it needs a 1/0 DCS with TR008 capability at the central office to integrate with the LDS.

In addition to the many Integrated Access System functionality's, the system also supports TR008 switch integration. The Integrated Access System with TR008 operation can connect directly to the LDS, eliminating the need for the 1/0 DCS as shown in Figure 2-2.

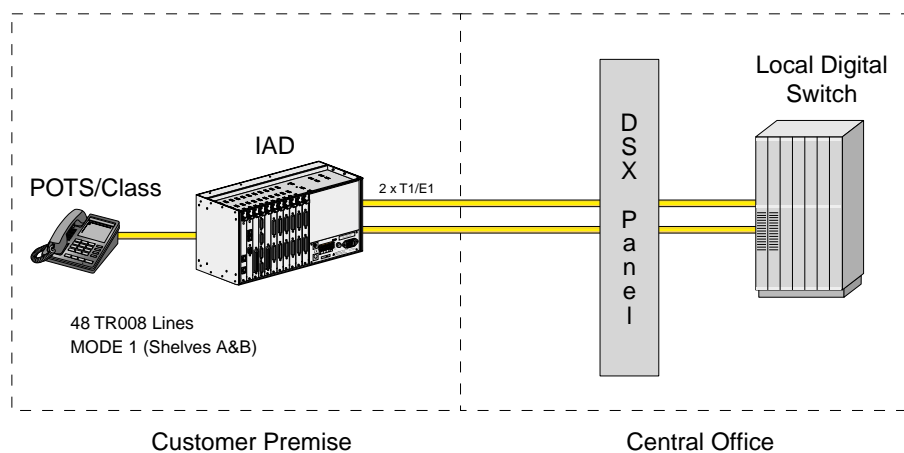

Figure 2-2. IAD using TR008

The TR008 feature can support 48 lines on 2 T1 links. This is an ideal vehicle to provide integrated POTS services for line sizes of 48 and under. This system supports Mode I, Shelf A&B of TR008 specification. The system supports extensive testing and diagnostics capabilities which minimizes troubleshooting and allow high service levels.

2.2.6 T1-E1 Conversion Application

The Digital Access and Cross-connect System (DACS) capabilities and the signaling and companding conversion features of the Integrated Access System can be used to provide gateway functionality between a DS1 transport network and an E1 transport network. See Figure 2-3 for an illustration of this capability.

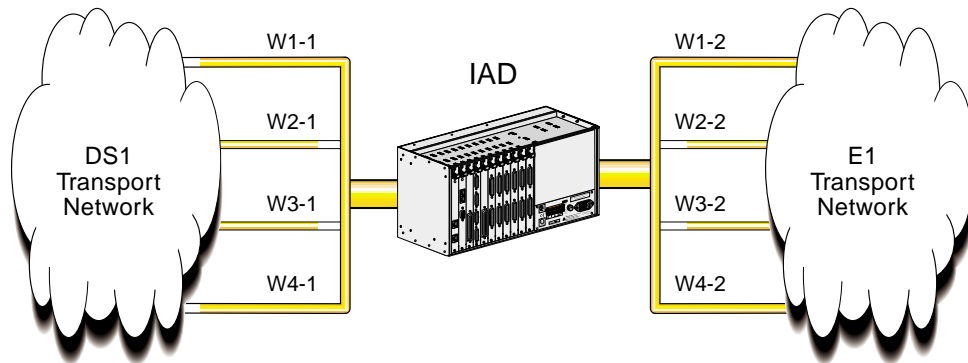

Figure 2-3. IAD using T1/E1 Conversion

Depending on the application, the signaling conversion can be set by the user to ITU-to-ANSI; ANSI-to-ITU or None. Similarly, the companding can be set by the user to A-Law-to- μ -Law; μ -LAW-to-A-Law or None. As shown in the figure above, each WAN card must be configured with one port for DSX1 and one for CEPT. A cross connection circuit must be made for each DS1 to E1 DSO re-assignment. Time Slots 0 and 16 cannot be used on the E1 link. Time slot 0 is used for timing and time slot 16 is used for Channel Associated Signaling (CAS). TS16 is available in data-only applications.

2.3 Data Modules and Applications

This Integrated Access System supports multiple user cards for transport of digital data.

2.3.1 HSU Card (820260, 820360, 821260, 821360, 821460, 821570, 821660)

The HSU card allows the connection of high speed data terminal equipment (DTE) and data communications equipment (DCE) to WAN links, server cards (ADPCM) or another HSU card. The HSU card also provides low or mid-density connectivity for local, synchronous peripherals such as, LAN Bridge/Routers and legacy SNA/SDLC devices. Additionally, these high speed data cards also provide broadcast functionality for point to multi-point operation suitable for applications such as video conferencing. When used in conjunction with an 8840 PRI Server Card, the HSU card can be used to provide switched data application functionality. (i.e. telephone call centers). All HSU cards can be installed in any of the User Slots in an Integrated Access System chassis.

The various models of the HSU Card are as follows:

- 820260 HSU card supports two RS530/RS449 data ports. It can also support V.35 and RS232 data through the use of the appropriate Personality module. Personality modules can be intermixed on the same RS530 card.

- The 820360 HSU Trunk Card supports two V.11/X.21 data ports. The ports may be configured as user ports, or can be used as externally clocked network interface ports.
- The 821260 HSU card supports two “true” V.35 synchronous data ports.
- The 821360 HSU Card provides two ports. Each port can be individually configured to support RS530 or V.35 devices. The 821360 also supports V.25bis dialing commands (an in-band dialing protocol) and RS366 dialing through the use of separate DB-15 pin RS366 port connectors on the rear of the card. The 821360 also has a proprietary in-band performance monitoring system.
- The 821460 HSU card supports two (2) V.35 synchronous data ports. The ports may be configured as user ports, or can be used as externally clocked network interface ports.
- The 821570 HSU card provides four ports which can be individually configured to support RS530, RS449/422, and V.35. devices.
- The 821660 HSU card provides four-ports which support four EIA530/A or V.35 data ports. The selection EIA530, EIA530A, or V.35 is made on a port-by-port basis using on-board switches. This enhanced HSU card is a derivative of the 821570 card, with better clock performance, a true V.35 interface and a receiver clock invert option.

Each port on a HSU can be independently configured to operate at speeds of Nx56 or Nx64 Kbps, where N equals 1 to 24 in T1 mode or 1 to 31 in E1 mode. In addition to the data rate, each synchronous port's Transmit Clock can be programmed for Internal or External modes and both the Clock and Data Polarity may be inverted through software.

The External Transmit Clock mode and the Inverted Clock Polarity mode may be useful in ensuring that both the Transmit Clock and the Transmit Data are in sync when they reach the HSU port.

This should occur when the HSU port and the attached device are connected over a long cable. The Data Polarity may be inverted to ensure the density for Nx64 Kbps data circuits supporting HDLC-based protocols that are connected to non-B8ZS T1 facilities.

The “Clear To Send” control lead may always be set to high, low or local mode. In local mode, the CTS signal reflects the state of the Request To Send (RTS) signal that is received from the attached DTE device. In that mode, the delay between RTS and CTS is software set-able, with options of 0, 30, 60 or 100 milliseconds. Additionally, if the HSU port is programmed to operate at Nx56 Kbps, then RTS will be transmitted end-to-end and presented as RLSD at the far end of the circuit.

Software-initiated diagnostics support include the setting of local loop backs towards either the network or the attached DTE equipment. Additionally, a remote loop back function allows the HSU card to generate three DDS-compatible latching loop back codes for the far-end OCU, CSU and DSU equipment. Similarly, the HSU data port may be programmed to detect and respond to both latching and non-latching DDS-format OCU, CSU and DSU loop back codes initiated from the remote end of the circuit. A time-out option authorizes the HSU port to automatically release the loop back after ten minutes. This feature applies to an HSU port that is running at 56 Kbps or for super-rate circuits if the loop back code is transmitted in the

first super-rate's DSO. The card can also generate and recognize two industry standard in-band loop-up and loop-down codes that act on the entire super-rate circuit. Those are the ITU (CCITT) V.54 code and the ANSI Fractional T1 code.

Additionally, the integral Bit Error Rate Tester (BERT) can be used to generate test patterns and route those towards the WAN facility. These test patterns can then be used to verify synchronization and measure circuit quality. For further information regarding Performance Monitoring and Diagnostic Capabilities, see Chapter 8, System Testing and Diagnostics.

Applications

There are several business applications the Integrated Access System equipped with an HSU card supports.

- LAN to LAN
- LAN to WAN to LAN
- Work Station to Computer
- Computer to Computer
- Compressed Video
- CAD/CAM
- Call Center

2.3.2 HSU Application Example

A major Health Maintenance Organization has numerous locations which have a Central main hospital facility and smaller satellite facilities. The HMO cannot afford to fully staff each main and satellite site with specialist. As patients enter the satellite facilities, video and audio sessions can be established with the specialists at the Main hospital. Although the satellite sites are not equipped with Intensive Care Units, emergencies can be admitted and support solicited from the Main hospital personnel as shown in Figure 2-4.

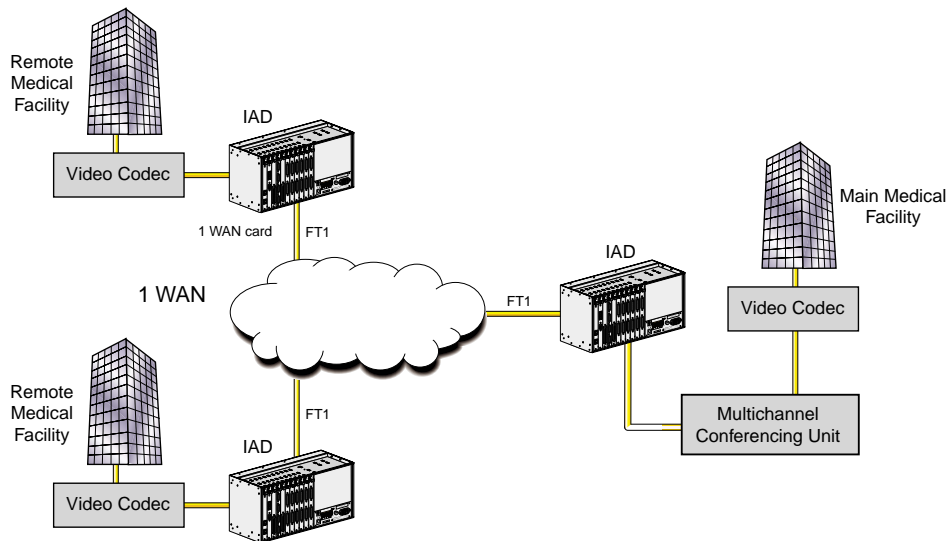

Figure 2-4. Point to MultiPoint One-Way Video and Audio using HSUs

2.3.3 SRU Card (822060)

The SRU card enables high density connectivity for local, synchronous or asynchronous peripherals. The 822060 SRU Card allows connections of up to ten RS-232, low-speed and medium-speed (300 bps to 38.4 kbps) data terminals to the Integrated Access System. Since an SRU port does not require a complete 64Kbps time slot, the Sub-Rate card allows you to multiplex a number of devices into a single, subdivided time slot on a WAN card. SRU card ports can also be multiplexed with voice traffic on an ADPCM engine.

Each RS-232 port can be independently programmed for synchronous (including HDLC) or asynchronous operation. Synchronous operation is available at speeds of 2.4 Kbps up to 38.4 Kbps while for asynchronous the range is 300 bps up to 38.4 Kbps. Each synchronous port can receive timing from either the DTE device or the system clock.

If the DTE supplies the transmit clocking, it must be synchronized with the system clocking source. For each asynchronous data port, the stop bits, data bits and parity are user configurable. The SRU incorporates a built-in V.14 Async-to-sync converter to avoid over-sampling and consequently saves bandwidth. Asynchronous data circuits are converted to synchronous mode by the SRU card prior to multiplexing onto a WAN aggregate.

Subrate data ports are multiplexed into industry standard DSO formats. The user may specify the format of the DSO that the data port is assigned to. The choices are: (1) DSO-A which allows only one data port to be mapped into the DSO and (2) DSO-B which allows multiple data ports from multiple SRU cards in the system to be mapped into the same DSO time slot. If the DSO-B format is selected, then the user can specify the type of DSO-B format required (b-5, b-10 and b-20) and the sub-rate position that the data port will occupy within the DSO-B frame.

In b-5 mode, the DSO is divided into five sub-rate positions, each of which are occupied by a data port operating at 9.6 Kbps, 4.8 Kbps, or 2.4 Kbps. Additionally, one or two 19.2 Kbps circuits are supported in b-5 mode. Each would occupy two of the five sub-rate positions. Additionally, data circuits running at 28.8 Kbps or 38.4 Kbps are supported in b-5 mode and will occupy three or four of the five available sub-rate positions.

In b-10 mode, the DSO is divided into ten sub-rate positions, each of which are occupied by a data port operation at 4.8 Kbps or 2.4 Kbps.

In b-20 mode, the DSO is divided into 20 sub-rate positions, each of which are occupied by a data port operating at 2.4 Kbps.

In the application shown in Figure 2-5, the IAD with the SRU card (on the right hand side) can either send each sub-rate on a separate DS0 (DSO-A format) or groom multiple subrate channels into a single DS0 (one of the DSO-B formats).

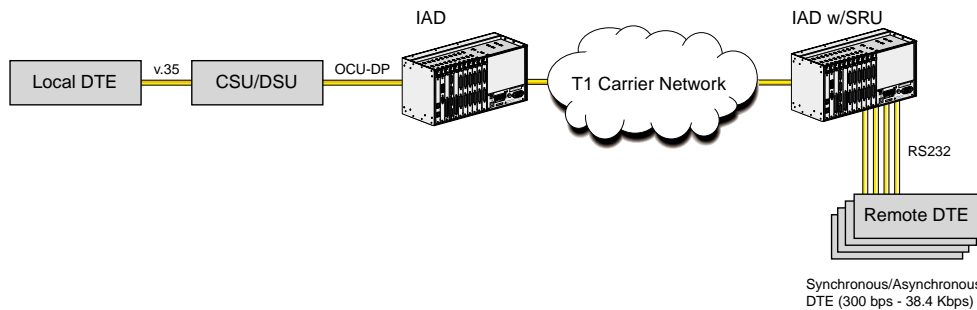

Figure 2-5. IAD with SRU Card Application

The SRU card also supports X.50 division 3, an ITU (CCITT) standard for sub-rate multiplexing. The maximum bandwidth of the SRU card is 115.2Kbps. The SRU card provides the ability for software configurable delay optimization. If delay optimization is used on all 10 ports, the maximum bandwidth available will be 76.8Kbps. Software-initiated diagnostics supported on the SRU card is the same as on the HSU card.

2.3.4 FRAD Card (823160)

The 823160 Frame Relay Assembler/Disassembler (FRAD) user card provides eight ports for transport of low speed data across Frame Relay Networks. The FRAD can encapsulate HDLC protocols (such as SDLC). Each port can be independently configured for asynchronous, transparent synchronous data or HDLC.

When taking data from the on-board RS-232 port, the FRAD card supports speeds of 2.4, 4.8, 9.6, 14.4, 19.2, 28.8 and 38.4 Kbps, independently configured on a per port basis. The aggregate Frame Relay encapsulated traffic coming out of the WAN card can be configured to transmit at 56 or 64 Kbps.

When processing HDLC data, the flags and the CRC are removed before assembling the frames. For asynchronous data, start and stop bits are removed before the frames are assembled. Other data is treated as a transparent data stream and all bits will be encapsulated into transmitted frames. The FRAD card supports proprietary sub-addressing over a PVC. This sub-addressing is transparent to the Frame Relay Transport Network, but allows multiple ports on a single FRAD to share the same PVC, resulting in lower costs.

The FRAD card also maintains performance statistics detailing the number of frames transmitted, number of frames received, number of octets transmitted, number of octets received, number of frames dropped before being received during a 15 minute interval and a status field describing the conditional that caused the dropped packets (DTE port down, loop back in progress or port in standby). All these performance statistics are gather for 24 hours, in 1 hour intervals. The FRAD card also provides test frame generators for additional diagnostics.

In the application represented by the Figure 2-6, the router on the left (at a remote office) is connected to the system via the FRAD card at 9.6Kbps, along with other voice traffic from a PBX.

The router traffic is mapped onto a DS0 on the T1 link to the Central Office where it is separated by a DACS and directed towards a Frame Relay network and switched/routed to the destination router at the headquarters. See Figure 2-6 for an illustration of the FRAD Card's capabilities.

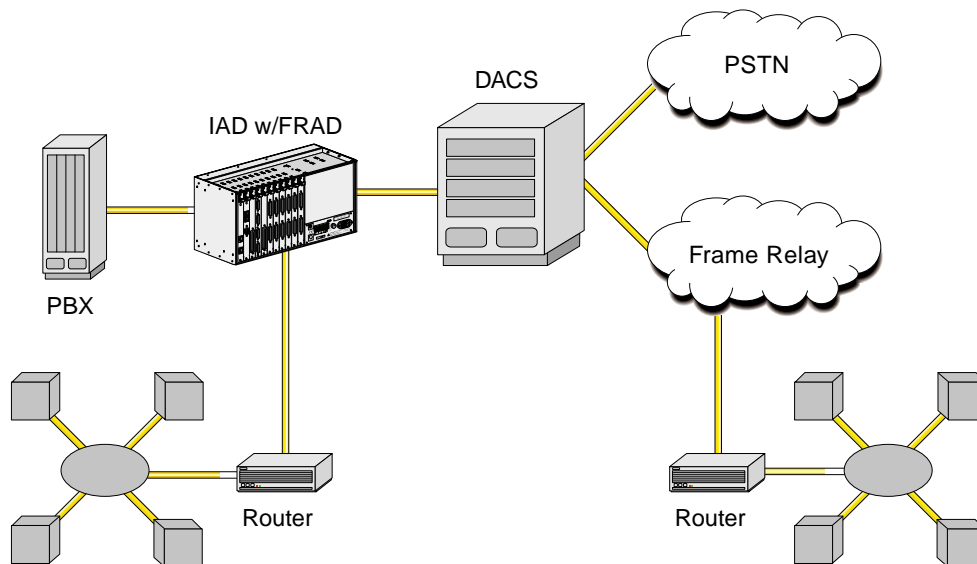

Figure 2-6. IAD FRAD Card Application

2.3.5 OCU-DP Card (824160, 824660, and 8249)

The OCU-DP (Office Channel Unit - Data Port) is used to interface directly to Data Service Units (DSUs)/Channels Service Units (CSUs) supporting data traffic up to and including 64Kbps. A four-wire circuit can connect the OCU-DP card to a DSU/CSU that can be located up to four miles away. In switched 56 Kbps mode, users can access the network on an as-needed basis by dial-up commands. The system unit must be equipped to provide -48 VDC power to fully support the functionality of the OCU-DP card.

2.3.5.1 OCU-DP Card Models

The Integrated Access System supports three cards for support of external CSU/DSUs that are stated below:

- 8249 OCU-DP 2 Port Card
- 824160 OCU-DP 5 Port Card
- 824660 OCU-DP 10 Port Card

All OCU-DP cards have RJ48 female connectors.

Each OCU-DP port can be independently programmed to operate at 2.4, 4.8, 9.6, 19.2, and 56 Kbps in either DS0-A, (one channel per DS0) or DS0-B format, which allows multiple data ports from multiple OCU-DP cards in the system to be mapped into the same DS0 time slot. If the DS0-B format is selected, then the user specifies the type of DS0-B format required (b-5, b-10 or b-20) and the sub-rate position that the data port occupied by the data port within the DS0-B frame.

In switched-56K mode, an OCU-DP port provides a connection for an external Switched-56K DSU/CSU that will perform all call set-up and dialing functions. The OCU-DP card converts the call set-up commands into standard signaling and sends the signaling over the WAN facility.

All OCU-DP cards support a low speed secondary channel that is established in the 8th bit position of the DS0 time slot to which the OCU-DP port is assigned. The secondary channel can be used for testing and maintenance of the main circuit or for the transmission of other, independent, low speed data. The specification table shows the secondary channel rates associated with the standard primary port rates of the OCU-DP card.

The 8249 OCU-DP card also supports two methods of error correction. The first is known as “Majority Vote” and applies to the lower data rates, specifically, 2.4, 4.8 and 9.6 Kbps. The other is known as the BCH (Bose-Chaudhuri-Hocquenghem) method and applies to data rates of 19.2 Kbps and 56 Kbps. In the case of a 19.2 Kbps circuit, the error correction information is placed in the same DS0 that the circuit occupies. In the case of a 56 Kbps circuit, the error correction information is placed in a following, adjacent DS0 time slot on the WAN aggregate.

On all OCU-DP cards' performance statistics is collected by the system and are available through the user interface. Performance statistics include Errored Seconds (any second with an error), Severely Errored Seconds (any second with an error rate exceeding $10E-3$) and Consecutive Severely Errored Seconds (CSES). They are displayed in hour intervals for up to 24 hours. CSES are counted by the system once ten consecutive Severely Errored Seconds are logged. The CSES counter stops if the system logs ten consecutive non-Severely Errored Seconds.

An OCU-DP port on the 8249 card may be programmed for OCU mode or CSU mode. OCU mode is the most common and is used whenever the OCU-DP port attaches to a CSU/DSU over a four-wire circuit. CSU mode allows the card to be connected directly to the digital network.

Software initiated diagnostics supported by the OCU-DP card include the setting of six different loop backs. Three of these act on the OCU-DP card itself and are known as local loop backs and the other three generate loop back patterns to remote devices and are known as remote loop backs. Among local loop backs, there are three types:

- loop backs of the 4-wire analog interface of the OCU-DP port towards the attached CSU
- loop backs of the 4-wire OCU-DP interface towards the network
- loop backs towards the network at the point where the OCU-DP card interfaces with the system bus

All three remote loop backs are latching loop backs. These latching loop backs are:

- loop back of the analog interface of the remote OCU-DP device back towards the network
- loop back of the 4-wire interface of the remote CSU device back towards the network
- loop backs of the 4-wire interface of the local CSU device towards the network.

An OCU-DP port may be programmed to detect and respond to both latching and non-latching (i.e., alternating) DDS-format OCU loop back codes that are initiated from the remote end of the circuit. A time-out option authorizes the OCU-DP port to automatically release the loop back after ten minutes.

2.3.6 BRI Card (826X Series)

The 826x line of BRI Cards offers industry standard ISDN BRI "U" or "S/T" Interfaces. Each BRI Card supports eight BRI "U" Interfaces for long line circuit provisioning, or "S/T" Interface for local provisioning. The BRI Interface provides two bearer and one data channel over two wires (1 pair). The S/T interface provides the same functionality over 4 wires (2 pair). In addition to this, each BRI "U" Interface supports 256x NTUs, providing remote NTU management.

The Basic Rate Interface “U” Interface card offers connectivity to sites located up to 18,000 feet from the Integrated Access System. This distance is influenced by factors such as wire gauge, bridge tap and loading patterns as described in ANSI T1.601-1992 specifications. The BRI cards are equipped with eight “U” interfaces that can carry one BRI, 2B+D channel. This will give users either two 64 Kbps or one 128 Kbps bearer channels per interface. The “U” Interface is also provides optional sealing current for maintaining wire pair performance.

When used with WAN and Server Card options, the BRI card facilitates BRITE (BRI Terminal Extension), leased line or IDSL (2B1Q) Provisioning, BRI to PRI operation and BRI (data) to Frame Relay Operation.

BRITE allows the Integrated Access System to extend the reach of an ISDN PBX hundred of miles away from the location of the PBX switch as shown in Figure 2-7. All services are passed to the remote location with no restrictions, enabling the end user or agent to use all PBX functionality as if they were locally attached to the switch. Management of this solution is transparent to the PBX programmer. All remote extensions are treated as if they are local connections. No special programming or management is necessary. For example, if there was an ISDN switch located in Los Angeles, ISDN capabilities could be transparently transported across the network to a remote call center in New York.

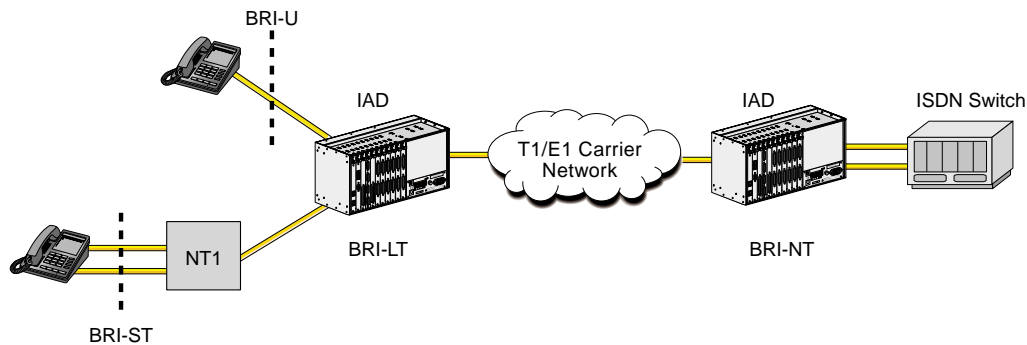

Figure 2-7. BRI Terminal Extension Application

The BRITE mode supports switched connectivity to ISDN capable switches and D channel signaling on either a full DS0 or multiplexed 4:1 on a single DS0. The ability to multiplex 4 D channels onto one DS0 allows for more efficient provisioning.

Another application of the BRI card is for leased line, or IDSL (ISDN Digital Subscriber Loop) as shown in Figure 2-8. This allows for the a DDS type circuit, with 2 * 64 kbps bearer channels over a single wire pair. The leased circuit can be any standard 2B1Q (U interface) NTU device that supports “nailed-up” (1 or 2B channels) connections and no D channel signaling.



Figure 2-8. BRI Card in a Leased Line or IDSL Application

2.3.6.1 BRI Card Models

In both cases, leased line and BRITE, B channels carrying voice traffic on the BRI card can be compressed through the ADPCM card to extend the user's resources. The only limitation on BRI traffic is that NTUs or NT1s must be located less than 18,000 feet from the system unit. All BRI cards are built to GR-1089 specifications.

The 826070 BRI "U" Card has software configurable mode operation of LT and NT. It supports up to eight leased or BRI terminal extension (BRITE) applications. The 826070 does not support sealing current.

The 826171 BRI "U" Card has all of the functionality of the 826070, however, switching between the LT and NT modes must be done by making a menu selection and changing jumper connections on the card. Also, the 826171, unlike the 826070 card supports a user configurable sealing current of 7.5mA or 15.0mA.

The 826270 BRI Card "S/T" Card is designed to support "S/T" 4-wire interface applications. This card provides TE, NT1 and NT2 emulation and is commonly used to provide remote extension of four-wire BRI CPE devices from an ISDN PBX.

The 826x70 series of BRI cards are also designed to support external timing part of the standard functionality. All BRI cards support extensive built in diagnostics and tests. Loop backs can be generated on a per channel basis, with choice of loop back generation mode and loop back codes. Built in BERT tests include off, mark, space, 1:1, 1:7, p_1, p_0, p_1:1, p_1:7.

In addition to all of the software configurable options on the BRI card itself, the BRI card has the ability to remotely manage up to eight NTUs. The NTUs DTE interface type, data rate and asynchronous baud rate are a few options that are configurable through the BRI card interface. This further enhances network manageability by accessing all ISDN equipment from a single platform.

2.3.7 DSO-DP Card (825460)

The 825460 DSO Data Port/G.703 Data Unit (DSO-DP/G.703) is a plug-in user card for the system. The DSO-DP/G.703 provides a 64 Kbps interface to a DSO of a T1/E1 network. The card supports four (4) ports each of which provide a 64 Kbps interface to a DSO on a T1 or E1 WAN link. Each DSO-DP/G.703 card can be installed in any User Slot and provides four (4) DB15 female connectors.

The DSO-DP/G.703 card can be programmed to operate in either DSO-DP mode or in G.703 mode. In G.703 mode, the card supports either co-directional or contra-directional operation and that option is set-able on a port-by-port basis. In DSO-DP mode, in addition to Transmit Data and Receive Data, the card can be programmed to either provide a 64 Kbps bit clock and an 8 kHz byte clock to the attached device or to receive those two clocks from the attached device.

In G.703 Co-Directional mode, the Transmit Data and Receive Data leads are supported. The clock information and the data make up a composite signal and the clock must be derived from the data stream. In G.703 Contra-Directional mode, the port provides separate Transmit and Receive Clocks to the attached device. Both clocks are 64 Kbps clocks with embedded 8 kHz Bipolar Violations (BPVs) to mark the byte boundaries.

Software-initiated diagnostics supported on the DSO-DP/G.703 card include the setting of local loop backs towards either the network or the attached DTE equipment. In addition, a remote loop back function allows the DSO-DP/G.703 card to generate four DDS-compatible latching loop back codes for the far-end OCU, CSU, DSU or DSO-DP equipment respectively. A time-out option authorizes the DSO-DP/G.703 port to automatically release the loop back after ten minutes.

2.3.8 B7R IP Concentrator Card (822860)

The 822860 B7R IP Concentrator card provides a means of concentrating network management data from up to 8 remote IADs onto a single asynchronous SLIP link for connection to a NMS. Normally, the NMS is LAN based and an asynchronous terminal server is also required to interface the SLIP link to the LAN.

Management information from remote Integrated Access Systems can be directed to the IADs containing the 822860 over the Facilities Data Link (FDL) or an ESF T1 link as shown in Figure 2-9. FDL is a 4 Kbps channel normally used to manage the T1 link. When the FDL is used to carry management data it is no longer able to carry T1 management data as well.

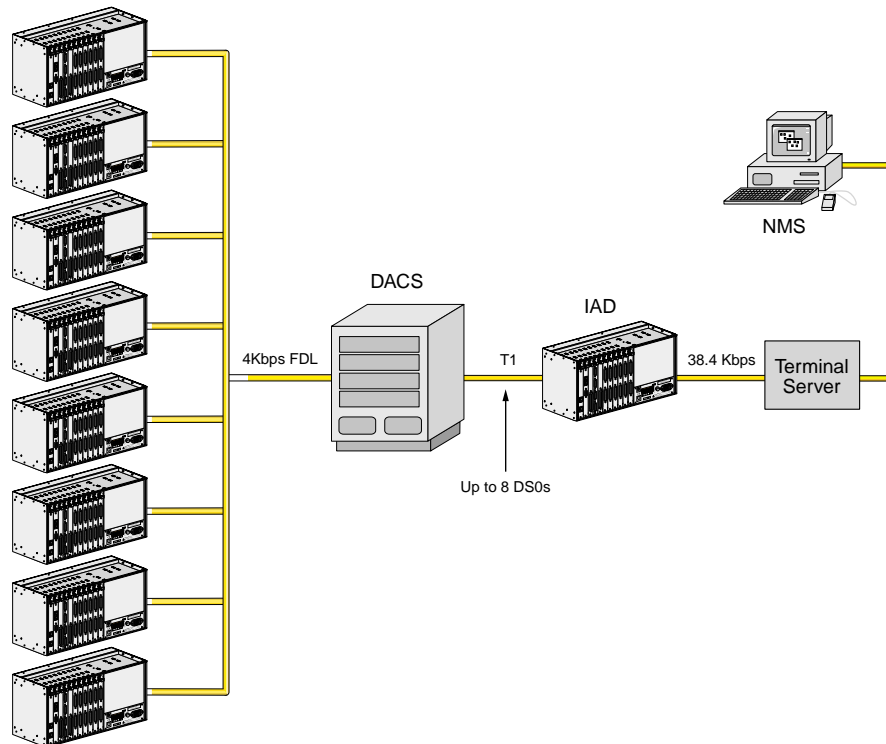

Figure 2-9. B7R Card used for Network Management (822860)

The remote systems must be configured with the TCP/IP CPU software option. Remote units send management information in IP packets over the FDL to an intervening AT&T DACS II. The DACS II can be configured to convert the IP management information from the FDL channel into a full DS0 using a link level protocol called Bit-7 Redundant (B7R).

Even though the management information is only 4 Kbps it will occupy the full 64 Kbps DS0. The resulting 8 DS0s are then routed over T1 link(s) to the Integrated Access System that contains the 822860.

Physically the 822860 is the same card as the 822060 SRU card. Both have ten RJ-48 interface ports, but on the 822860 the first eight are physically disabled and, effectively, replaced by eight “internal” ports used for the DS0s. The ninth RJ-48 port is available for maintenance and the tenth RJ-48 port is used for the aggregate SLIP line to the terminal server.

2.4 ADPCM Voice Compression Server (887160)

The 887160 ADPCM (Adaptive Differential Pulse Code Modulation) server card is designed to compress digital and analog voice traffic for transmission over wide area network links. The level of compression for an individual channel is software configurable at 24Kbps, 32Kbps or 40Kbps. A single ADPCM card is capable of compressing 64 channels of voice simultaneously.

Since the ADPCM card is a server card, these 64 channels can be originated from a variety of interfaces, including FXS, FXO, E&M, SRU, BRI, and T1/E1. Up to two ADPCM server cards can be supported per Integrated Access System for a total of 128 compressed voice channels. A third ADPCM server card can be utilized for 1:N redundancy.

The sum of the compression rates for the engine pair must equal 64Kbps. A 32Kbps circuit can only be paired with a 32Kbps circuit. A 40Kbps circuit can only be paired with a 24Kbps circuit and vice-versa. The ADPCM server card can also pair a low speed asynchronous data transmission (19.2Kbps or less) from an SRU port with a 40kbps engine. This data path will occupy a 24Kbps engine. Group II FAX is supported in 32Kbps channels and Group III FAX is supported in 40Kbps channels.

Modem support up to 4.8Kbps, and V.32bis to 9.6Kbps is supported in 32Kbps channels. Modem speeds up to 12Kbps, and V.32bis speeds up to 14.4Kbps is supported in 40Kbps channels. Modem data is not supported in 24Kbps channels.

The ADPCM card supports Transition Signaling as defined by ANSI T1.302-1989 with the exception of the Alarm bits. ANSI T1.302 specifies signaling at the 32Kbps compression rate. The ADPCM card uses this scheme for 24Kbps and 40Kbps although it is not included in the standard.

The ADPCM card can be used in a variety of applications to reduce the number of transmission lines for efficient transport of voice traffic. It can be used in:

- PBX to PBX trunk application
- Automatic Call Distribution application
- Efficient wireless base station/hub application

2.4.1 PBX to PBX Trunk Application

Figure 2-10 shows the IAD with an ADPCM server used to compress two T1 or E1 PBX-to-PBX trunks into a single trunk. The voice from each PBX is connected via a digital T1 or E1 connection to the IAD. The voice channels are routed to the ADPCM server, where each voice channel is compressed to 32 Kbps. The compressed voice is routed to the outbound T1/E1 link to the other IAD unit, where it is decompressed and placed back into two T1 or E1 trunks to the remote PBX. PBX to PBX trunk lines can be compressed 2:1 to reduce leased line charges. The application is also valid for analog PBXs and key systems.

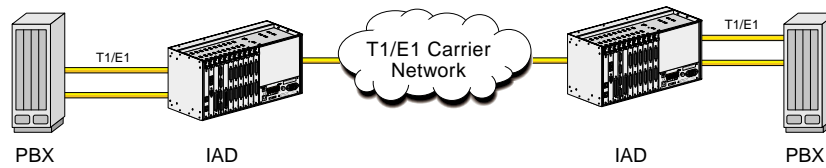

Figure 2-10. IAD using ADPCM for PBX to PBX Application

2.4.2 Automatic Call Distribution Application

The ADPCM server can be used to reduce leased line charges in automatic call distribution or remote call center applications by increasing the number of voice circuits supported on a single T1 or E1.

The application shown in Figure 2-11 illustrates an ISDN-based automatic call distribution system. The Integrated Access System is used to provision BRI remotely via BRITE (BRI Terminal Extension). With the IAD, ten BRI circuits can be extended to remote locations over a single T1 line, and 13 over a single E1 line. The IAD is able to do this by placing the 2B+D signal into 2.25 time slots (1 for each B, and .25 (16Kbps) for the D channel).

The ADPCM server is used to increase the number of BRI circuits supported per T1 or E1 by compressing the B channels in voice only applications. This means that a 2B+D channel can be transported in 1.25 time slots (.5 for each B, and .25 for the D channel). Hence, 19 BRI circuits (38 voice channels) are transported over a single T1 and 24 BRI circuits are transported (48 voice channels) over a single E1.

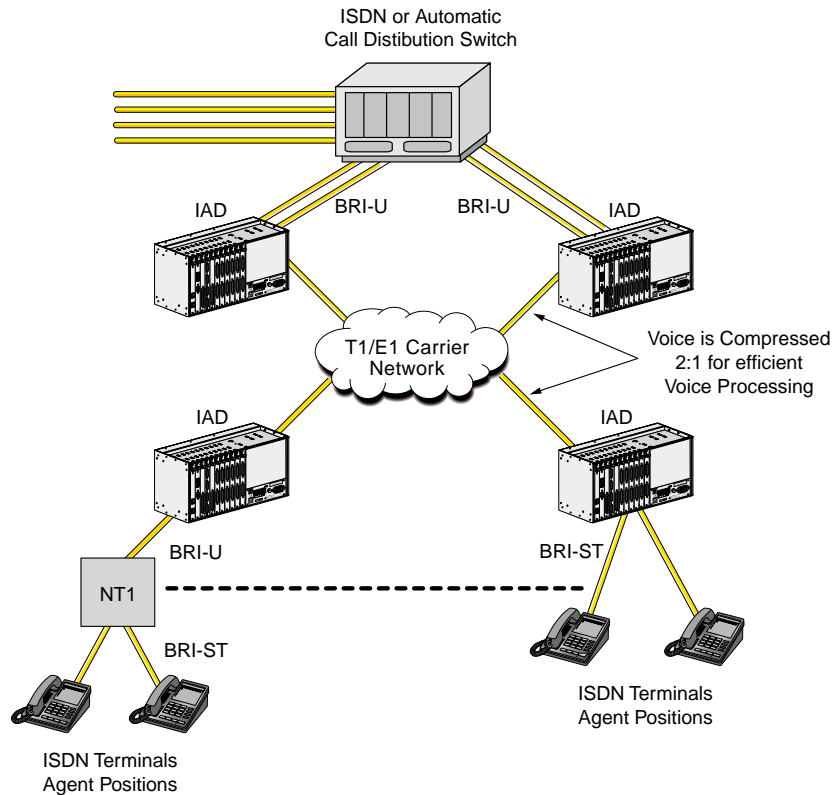

Figure 2-11. IAD in an ISDN-based ACD System

2.4.3 Wireless Base Station Application

In the application shown in Figure 2-12, the IAD is used as a channel bank at each of the remote Base Stations. In each of the stations, the IAD is connected via T1/E1 or Analog voice ports to the radio transmission equipment. The voice circuits that are destined for the switching center are sent to the ADPCM voice compression server at each base station. This compressed voice traffic is then groomed with other Base Station data traffic and transmitted over Fractional T1/E1 lines. An IAD is used at a central location to groom the Fractional T1/E1 lines into two T1s or E1s. These two lines are connected to the Switching Center where an IAD with two ADPCM servers is used to decompress the voice circuits and send them to the switch via four T1s or E1s.

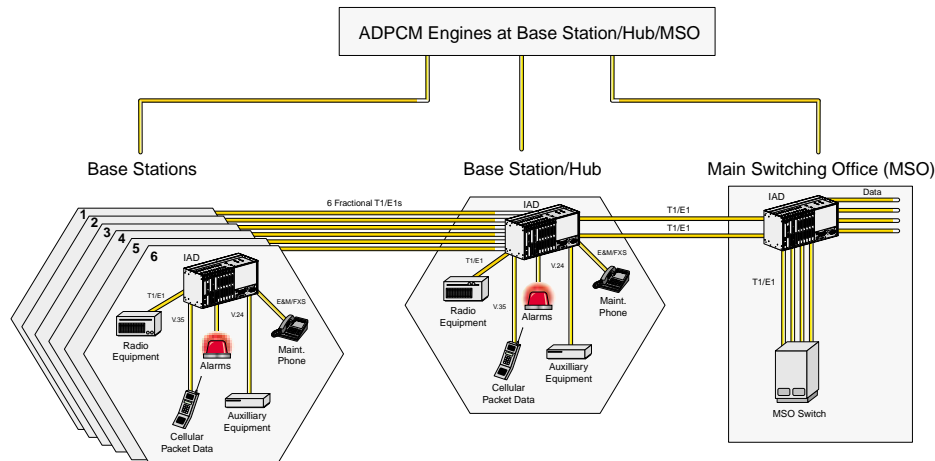

Figure 2-12. IAD in a Wireless Base Station Application

Base Station to MSO voice traffic can be compressed to efficiently backhaul traffic, which reduces line charges. An alternative to this application would be to transport the voice from the Base Station to the Hub uncompressed over the Fractional T1s and E1s and then perform the voice compression function in the IAD at the hub.

2.5 ISDN Primary Rate Interface (PRI) Server (884060)

The PRI Server Card (884060) provides flexible access and routing of PRI-based ISDN services. The ISDN PRI Server can be used for enabling applications such as Video Conferencing, Video Broadcast, ISDN Grooming, and Fractional PRI provisioning. The PRI Server card supports B channel bandwidth of 56K, 64K, 384K, 1536K and Multi-Rate speeds where available. Multi-Rate speeds allow the PRI server card to select calls in increments of 64Kbps. In areas where Multi-Rate is not supported by the local ISDN switch, an Inverse Mux (IMUX) Server Card should be used to aggregate individual 64Kbps calls.

The PRI card can be utilized with the 821360 Switched HSU Card for RS-366 and V.25bis bandwidth on demand dialing. Additionally, regular HSU cards can be used for DTR dialing. The PRI server card supports both the Network and User side protocols associated with ISDN PRI services and therefore the IAD can be used to both provision and terminate ISDN calls.

The following components make up the BRI/PRI solution:

- One 881162 Multi-Server Card
- One 65130 BRI/PRI Service Translation Software Package
- Optional WAN Interfaces with associated Line Interface Modules
- Optional ISDN 'U' Interfaces
- 884060 ISDN PRI Server Card with 8 D Channels

The cards provide flexible access to PRI-based ISDN services such as Switched 384, Switched T1, and Switched 56/64. The PRI Server Card (PRI card) provides both local D channel origination and termination and D channel consolidation. It offers a perfect alternative to standalone ISDN access devices when other “non-ISDN” voice and data services must be consolidated in addition to ISDN services.

The 884060 ISDN cards can be simultaneously connected to several network and user side ISDN PRI facilities. The ISDN PRI card provides D channel support of both the network side protocol and the user side protocol. Typically, the IAD with an ISDN PRI card, supplies the network side protocol on a D channel connected to a PBX, and provides the user side protocol on the D channel connected to a carrier switch.

The 884060 ISDN PRI server card can also be configured to route calls from a PBX, multiple PBXs, and DTE devices to multiple ISDN service providers. The 884060 ISDN PRI Server does not support BRI-to-PRI translation. This application is supported by the 65130 ISDN BRI-PRI translation software running on an 881162 ACS card.

2.5.1 NFAS (Non-Facility Associated Signaling)

All ISDN PRI cards can be configured to support NFAS (Non-Facility Associated Signaling). The limit for NFAS is 191B+D in T1 environments (8 times 24 minus 1 D channel) and 239 B+D in E1 environments (8 times 30 time slots minus 1 D channel).

A basic ISDN PRI facility is a T1 link that consists of 23 B channels and 1 D channel (23B+D), or an E1 link that consists of 30 B channels and 1 D channel (30B+D). Note that one time slot on any E1 link is reserved for maintenance use and is neither a B channel nor a D channel. The D channel provides signaling for all of the (23 or 30) B channels on the facility carrying that D channel.

However, many ISDN applications have relatively low call rates (i.e., the D channel is not very busy), but need more than 23 (or 30) B channels to carry user (bearer) traffic. In these cases, a D channel can be set up to perform signaling not only for the B channels on its own facility, but also for B channels on other facilities (i.e., other T1/E1 WAN links). When a D channel is so provisioned, it is considered to be performing non-facility associated signaling (NFAS).

The system is limited to 8 WAN links. Thus the system limit for NFAS is 191B+D in T1 environments (8 times 24 minus 1 D channel) and 239B+D in E1 environments (8 times 30 minus 1).

Although this Integrated Access System supports NFAS, it can only be implemented within private networks or in public networks where it is supported by the service provider. Within EC and EFTA countries NFAS is considered an EC-MOU2 supplementary service which is still at the discussion stage and therefore is not supported by any of the European Service Providers.

Remote Login

In addition to carrying ISDN signaling information, the D channel can also be used to log into a remote system unit to check card status, and perform necessary system maintenance. This unique application does not require B channel allocation. The ISDN call is placed on the D channel to the ISDN network and routed to the D channel of the remote unit. Coordination with the ISDN facility provider is necessary to obtain the number for the remote system unit.

Applications

The ISDN PRI Server card can be used in a variety of applications:

- Fractional ISDN PRI provisioning
- Video conferencing
- Integrated ISDN access with SINA
- Video Broadcast
- Router with redundant trunk routing via ISDN
- Router adding incremental bandwidth
- PRI to FXS

2.5.2 Fractional PRI Provisioning

An Integrated Access System equipped with a 884060 PRI Server card is used to groom multiple fractional PRI circuits into one or more PRI circuits for backhaul to an ISDN switch. Perhaps a customer may not need the entire bandwidth delivered by a PRI circuit. The optimal alternative would be to purchase a fractional PRI service delivered over a regular T1 or E1 circuit.

When a service provider has multiple fractional PRI customers, the service provider can deploy the Integrated Access System to groom the multiple fractional PRI circuits into one fully utilized PRI T1/E1 circuit which is back hauled to the switch. This concentration of PRI circuits reduced back haul costs for the service provider, and conserves T1/E1 ports and D-channels on the ISDN switch itself.

Figure 2-13 shows that three customers are subscribing to ISDN services. Each customer is using a fractional PRI service. Each customer could be directly connected to the ISDN switch, which would consume three fractional T1/E1 circuits, and three D channels. Instead, the 3 fractional ISDN circuits are connected to a PRI Server equipped IAD.

The PRI server grooms the B channels in the three fractional ISDN circuits into one circuit. It also grooms the three D-channel circuits into a single D channel that is routed to the switch. The IAD benefits in this application include saving on back haul costs, switch port costs, and switch system resources.

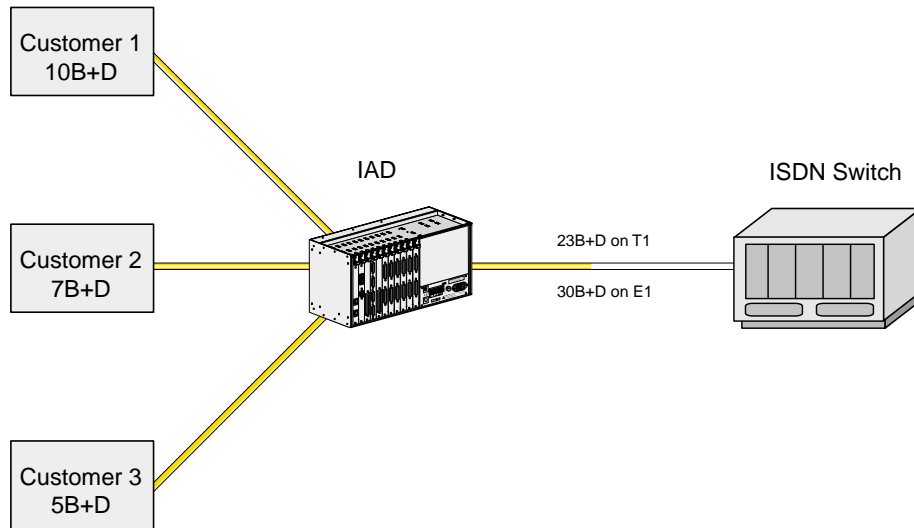

Figure 2-13. Fractional PRI Provisioning using an IAD

2.5.3 ISDN Video Conferencing and Video Broadcast

This Integrated Access System is used to connect video conferencing equipment to an ISDN PRI line. In Figure 2-14, a video CODEC is sharing a PRI line with an ISDN PBX. The system is simultaneously routing calls on a call by call basis to either the PBX, the CODEC, or out to the network.

The video conferencing equipment can be connected via an RS-449 connection with an RS-366 dialer or directly to the IAD via an ISDN PRI interface. A connection to the IAD via the RS-449/RS-366 combination would require the use of a switched HSU card in the IAD.

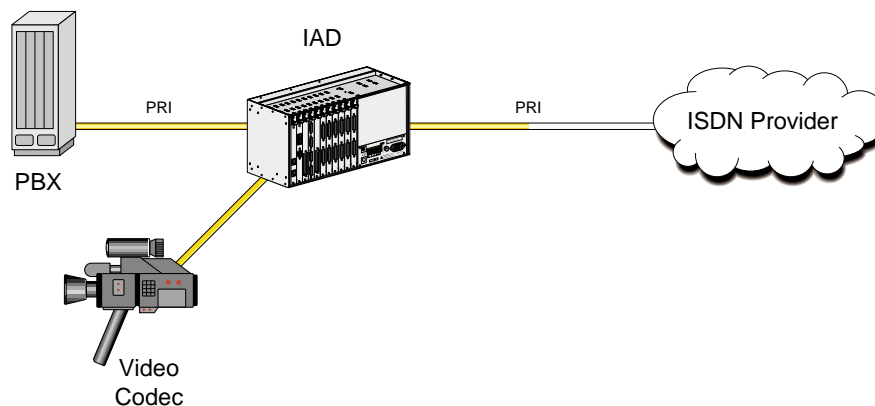

Figure 2-14. Video Conferencing System and PBX Sharing a PRI Line

By grooming the PBX and CODEC PRI circuits onto a single, outbound PRI facility, the IAD utilizes Dynamic Bandwidth Allocation (DBA). The PBX would seize B-channels on a call-by-call basis, utilizing one B-channel for every call. The Video Codec would request a pre-determined number of B-channels. For example, if a 384K call was required, the Video CODEC requests a single 384K circuit, which would consume six of the B-channels. If the ISDN service supports 384K calls, or Multi-Rate services, and the bandwidth is available, the ISDN server card will connect the Video CODEC to proper time slots. If the bandwidth is not available, the IAD rejects the call. If 384K service is not supported by the ISDN service, the IAD must be equipped with an Inverse Multiplexer (IMUX) server card. The IMUX server card is capable of bonding or aggregating multiple 64K circuits into a single larger capacity circuit.

Inbound calls would be handled in a similar manner. All inbound calls would be screened by the IADs PRI Server card. Calls destined for the PBX would be routed to the PBX, and calls destined for the Video Conference Unit would be routed there. If the video Codec was in use, the IAD will inform the ISDN service that the unit was in a busy condition.

A unique feature of the PRI Server card is its ability to combine multiple ISDN circuits to form a Video Broadcast. This feature is very useful for distance learning applications where a central site broadcasts video to multiple remote locations.

In this application, an IAD equipped with a PRI server card takes a video source and makes a two-way connection with the first remote IAD video conference site as shown in Figure 2-15. Once that connection is established, the host IAD calls up to a total of 32 additional remote video conferences sites and distributes the same outbound video feed to all of those sites.

These additional sites are in a view-only mode and do not distribute video back to the central site. The loss of one or more of the remote sites will not affect the broadcast to the other sites. This application can be upgraded to allow two-way audio to each of the sites though the use of analog voice cards.

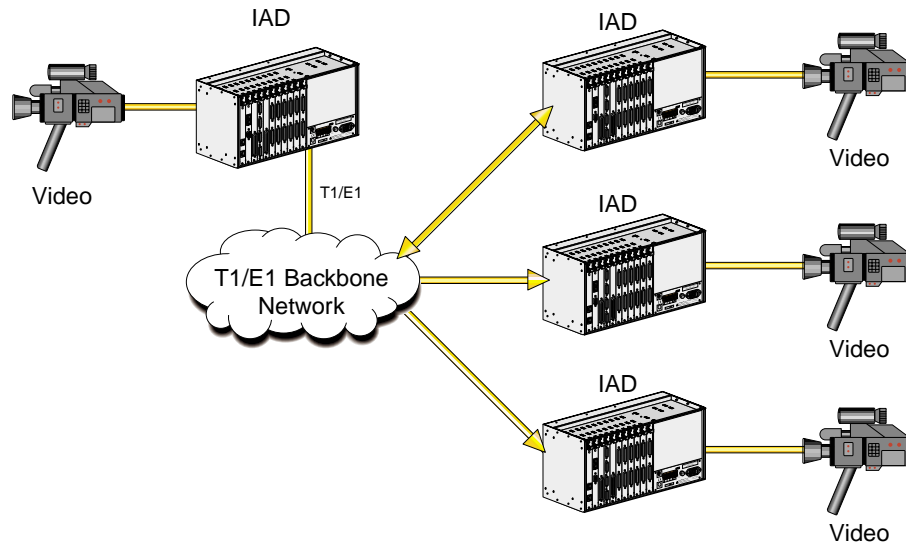

Figure 2-15. IAD in Video Broadcast Applications

2.5.4 Integrated ISDN Access with SINA

This Integrated Access System is used to support both ISDN and non-ISDN services over the same T1/E1 circuit. This multiplexing of leased line and ISDN services is commonly referred to as Static Integrated Network Access (SINA).

As shown in Figure 2-16, several non-ISDN applications are used including analog voice and data applications, low speed SNA data, and non-ISDN PBXs. Several ISDN based applications are being used including Video conferencing, dial routers, and an ISDN PBX.

The non-ISDN circuits are groomed onto the T1/E1 circuit for delivery to the network. ISDN applications are sent to the PRI Server card for concentration and are switched onto the same T1/E1 circuit in time slots appropriate for switched ISDN calls. Within the network, these circuits are groomed via a cross-connect to the appropriate services.

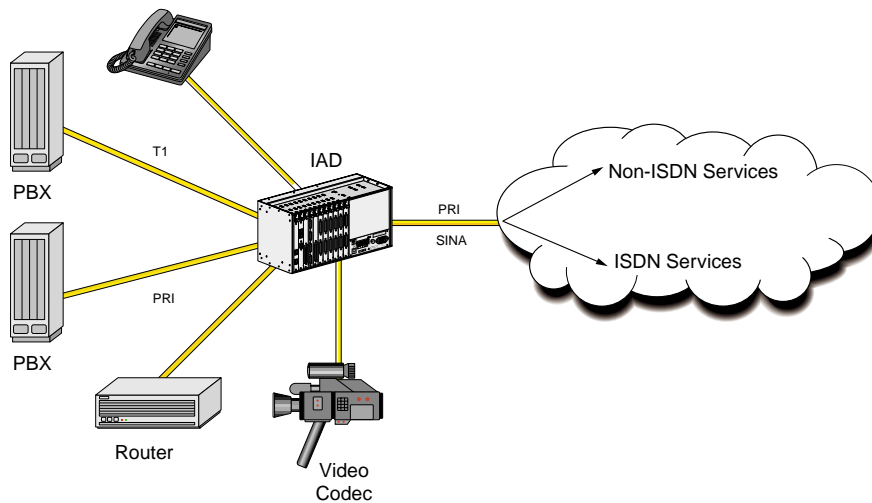

Figure 2-16. IAD using SINA for ISDN and Leased Line Traffic

2.5.5 Data Backup and Bandwidth on Demand

This Integrated Access System with a PRI server is used to back up data networks in the event of a circuit outage. In the example shown in Figure 2-17, an IAD is used to connect a router to a leased line circuit. The PBX is using the IAD equipped with a PRI server card to connect to the PRI circuit. In normal operation, both the voice traffic and the data traffic simply pass through the IAD. In the event that the leased line circuit is dropped the router will sense the loss of data and attempt to dial bandwidth via its second line. This second port can be configured on the IAD to accept dial commands using the V.25bis, or to dial a pre-determined number when the IAD senses DTR.

When the router senses that a failure has occurred, it will request bandwidth from the IAD. If the PRI does not have enough bandwidth to satisfy the router's request, the IAD rejects the call. The router will then request another call with smaller bandwidth requirements and will monitor the original leased line for presence of data. When the router detects that the leased line is back in operation, it will switch its transmission path back to its original state, and drop the ISDN connection.

This configuration is utilized to provide bandwidth-on-demand during peak utilization times such as nightly backups. With this application, the PBX utilizes the PRI bandwidth on a call-by-call basis during the day, and the router utilizes the leased line. At a pre-determined time-of-day, the router would request all or the majority of the PRI bandwidth.

The router utilizes both the leased circuit and the ISDN circuit for a set period of time. For example, the PRI line would be used during the day to carry the voice calls, at night the PRI line would be used to increase the bandwidth available for the nightly computer systems backup. The router routes packets over both the leased line and the PRI line until the backup was complete. At that time, it would disconnect the PRI call.

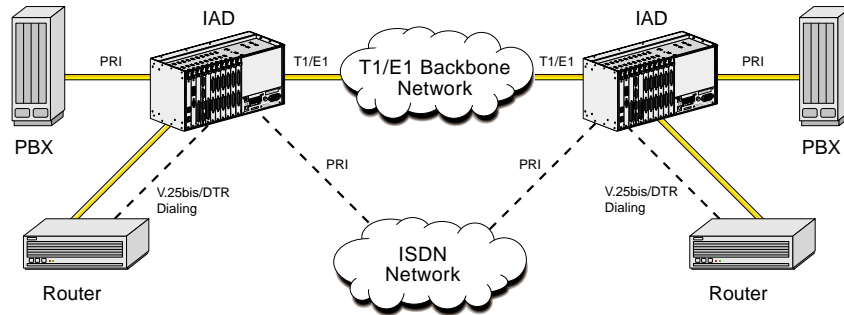

Figure 2-17. IAD using a PRI Server Card for Data Backup

2.5.6 PRI to FXS termination

This Integrated Access System is used to connect calls to an analog modem rack as shown in Figure 2-18. This application is usually used to terminate a mix of ISDN originated calls and analog modem originated calls to the same destination. This is common in remote access applications where there is a need to support both existing analog modem applications and new digital ISDN connections over the same network facility.

End users can migrate as needed from analog modems to ISDN, sharing the same facility, and maximizing utilization of network bandwidth. The IAD receives all calls, examines the called number and routes the analog modem calls to the FXS hunt group.

ISDN data calls are routed directly to the ISDN remote access server. This application only works for inbound calls since the modems in the rack can not be used to dial out through the IAD over ISDN.

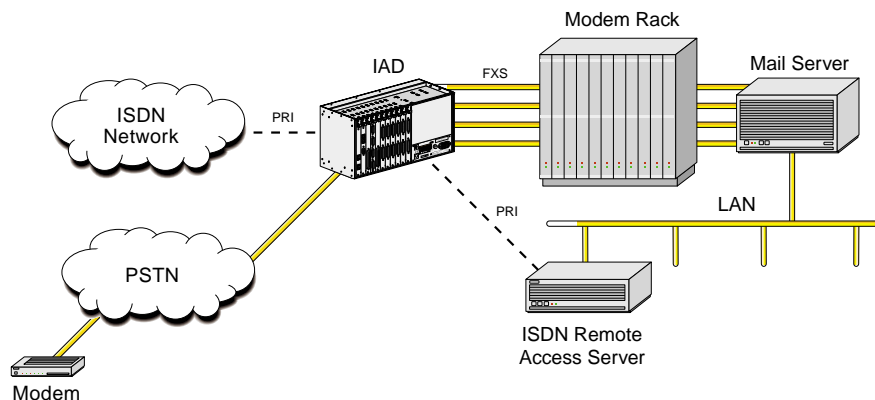

Figure 2-18. PRI to FXS Termination

2.5.7 Routing Capabilities

2.5.7.1 Call Routing

This Integrated Access System can be simultaneously connected to several Network and User side ISDN PRI facilities and to a user's data terminal equipment such as a video codec or LAN router. DTE is usually connected to the system's HSU cards.

Any call originating from a HSU port (with the exception of the Switched HSU card), must be associated with a call profile. The call profile specifies which D channel is to carry the call. Any device attached to an HSU port that is able to receive incoming calls is assigned a unique number that allows the system to route the incoming call to it. Optionally, a shared hunt group phone number can be assigned to the same HSU port.

When an incoming call is received by the system, it first scans all of the primary HSU or FXS phone numbers to attempt a match. If no match is found, the system then searches the list of hunt group numbers to find a match. If a match is not found, the system will begin searching the D channel routing tables, for routing of the call to a PRI line. If no matches are found, the call is rejected.

2.5.7.2 Local Routing

From an Integrated Access System perspective, devices such as video codecs or PBXs that are directly attached to the system, (i.e. do not pass through a carrier network to connect to the system) are considered "local" devices. All HSU ports are local devices. Any PRI device, such as a PBX, that is connected to an system D channel configured for "Network" side is a local device. Local routing is defined as call routing between any two devices. Calls can be locally routed from a PRI to a PRI (for example, from a local PBX to another local PBX), or from an HSU to a PRI. HSU to HSU call routing is not supported.

Incoming calls are routed based on the called phone number, not on call profiles. Because the system does not provide billing information, users may want to prohibit local routing of D-channels. For example, a carrier may require that all calls are routed through the CO based switch for billing purposes. To provide for this, local routing can be disabled.

If local routing is disabled, any call coming into the system on a network side (i.e. local) D channel will be routed only to a user side D channel based on the called number. Even if the called number matches, such a call will never be routed to an HSU port or a network side D channel when local routing is disabled.

When local routing is enabled, then any call coming in on a D channel will be routed to the first matching phone number, regardless of whether or not the match is for a local device.

2.5.7.3 Bi-directional Default Routing

Bi-directional Default Routing is provided for automatic routing when a node is configured with two Primary Rate D channels as shown in Figure 2-19.

In two channel systems, the user does not have to configure any routing information, as all calls received on one D channel are automatically routed to the second D channel. The user only needs to enter routing information for those calls destined to a local HSU or FXS ports.

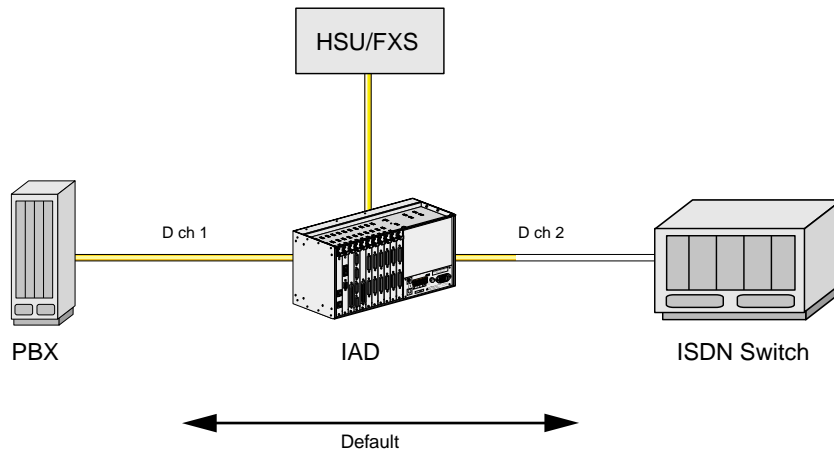

Figure 2-19. Bi-Directional Default Routing

2.5.7.4 Alternate routing

Alternate routing is provided for calls to take an alternate path in the event of a congested or failed primary trunk. When there are more than two Primary Rate D channels, phone numbers can be assigned to more than one D channel. Calls placed or routed through the PRI server will now have an alternate route if no bandwidth is available on the first specified path.

Alternate routing will also take place in the event of a failure of the first Primary Rate circuit. In the example shown in Figure 2-20, the call from D1 is usually routed to D2, as the D channel numbering is more specific. However, should the D2 trunk become congested or go out of service, the call will be routed to D3.

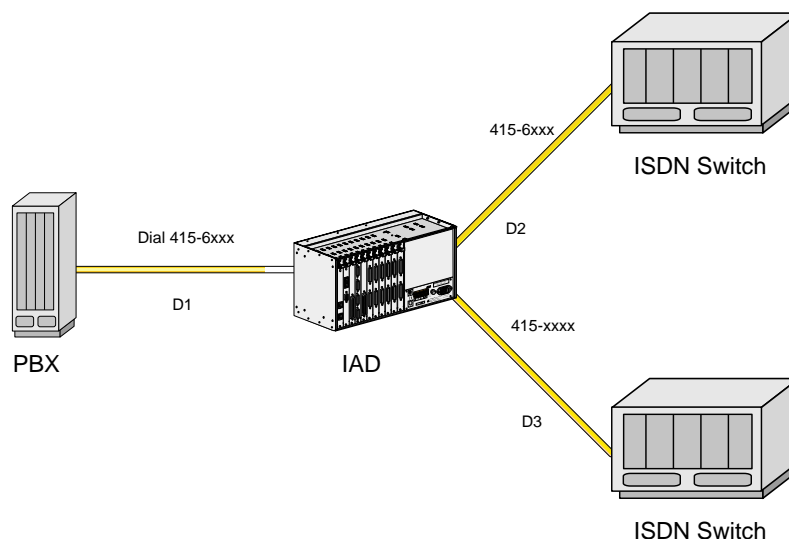

Figure 2-20. Alternate Routing

2.5.7.5 DPNSS Trunk Routing

Digital Private Network Signaling System #1 (DPNSS) is the predominant Common Channel Signaling scheme used in the United Kingdom for private inter PABX communications. DPNSS Trunk Routing, provides low delay for multi DPNSS channel provisioning off a single E1 DPNSS aggregate. This is achieved by mapping the B channels to dedicated time slots rather than to hunt groups, which in turn provides efficient D channel grooming and subsequent billing.

2.6 Management Channel Concentrator (MCC) Server (881360)

The Management Communications Concentrator (MCC) provides management connectivity to remote Integrated Access Systems. It can concentrate the TCP/IP management traffic from up to 131 remote IAD clients onto either a single, local 10 BASE-T Ethernet port, or encapsulate the information as per RFC1490 on to a Frame Relay link.

There can be up to 3 MCC server cards in an IAD chassis in non-redundant operation. The following hardware and firmware must be included in an IAD to add MCC Server operation:

- 880360 CPU Control Card with 8 T1/E1 Cross Connect (redundant-capable)
- 892260/892261/892360/892460 - 8 T1/E1 Interface card w/ 128K NVRAM.
- 881360 Advanced Communication Server (ACS) with 131 logical ports
- 60500 or above Host Firmware version

- 63110 or 63120- MCC Server firmware

The following protocols are supported by the MCC:

- Ethernet Media Access Control Protocol (MAC)
- Address Resolution Protocol (ARP)
- Internet Protocol, version 4. (IP)
- Internet Control Message Protocol (ICMP)
- User Datagram Protocol (UDP)
- Routing Information Protocol (RIP)
- Frame Relay (RFC1490)

The MCC provides management of remote IADs' using TCP/IP and SNMP/UDP/IP through the FDL bit of the ESF format if used for T1. For E1, management is provided through the SA4 bit of the frame following the frame alignment word in time-slot 0. The MCC offers far more interfaces and functionality than the B7R, thus replacing it, and the device used to route between the asynchronous aggregate serial port and Ethernet.

MCC can be configured to use unnumbered or numbered interfaces. If unnumbered interfaces are used, MCC is accessed through the global Ethernet address regardless of what interface is used. If numbered interfaces are used, each interface has a local IP address. Unnumbered interfaces help conserving IP addresses as only one address is used per interface. This addressing method may not be compatible with HP Openview.

The MCC routes IP datagrams between all of its interfaces, based on each datagram's IP destination address.

Datagrams are directed (or routed) to the interface carrying the sub-net to which the datagram belongs or is being transported to, according to the content of the routing table. The routing table may be supplied with dynamic routes from the Routing Information Protocol (RIP) when enabled. If no match is found in the routing table, a default route can be designated to direct all unresolved datagrams to a specific interface.

Initial configuration of the MCC can be made through the local VT100 port. When a working interface is established to the CPU hosting the MCC, subsequent configurations can be done remotely via SNMP/TELNET. All configurable port parameters are permanently stored in NV-RAM and downloaded to the card during startup. An interface card remains in standby position until correctly configured and activated. Statistics are also available on both interface cards.

IP-based management information from clients is typically provided to the MCC by a Digital Access and Cross-connect System (DACS) as Bit Seven Redundant (B7R) or Bit Four Redundant (B4R) DS0 channels on a T1 or E1 link. The MCC routes IP packets among the 131 available WAN interfaces, the local host CPU and Ethernet. Each interface represents a separate network or subnet as specified by the IP address and Netmask combination. Three of the 131 are high-speed interfaces that can either be configured as Nx64 kbps (N=1 to 24 for

T1 or 1 to 31 for E1). Those interfaces can independently be configured for the Frame Relay protocol or for transparent HDLC. The 128 lower-speed WAN interfaces can be configured in groups of 64, to either be in BnR mode or plain 64 kbps. HDLC mode.

Figure 2-21 shows FDL channels from the remote IADs fed into a DACS II for translation into multiple B7R encoded DS0 channels. IAD I, connected to the DACS II, routes IP datagrams to IAD II through the alternative high-speed interfaces. IAD II in turn routes datagrams to the Local Ethernet to the NMS.

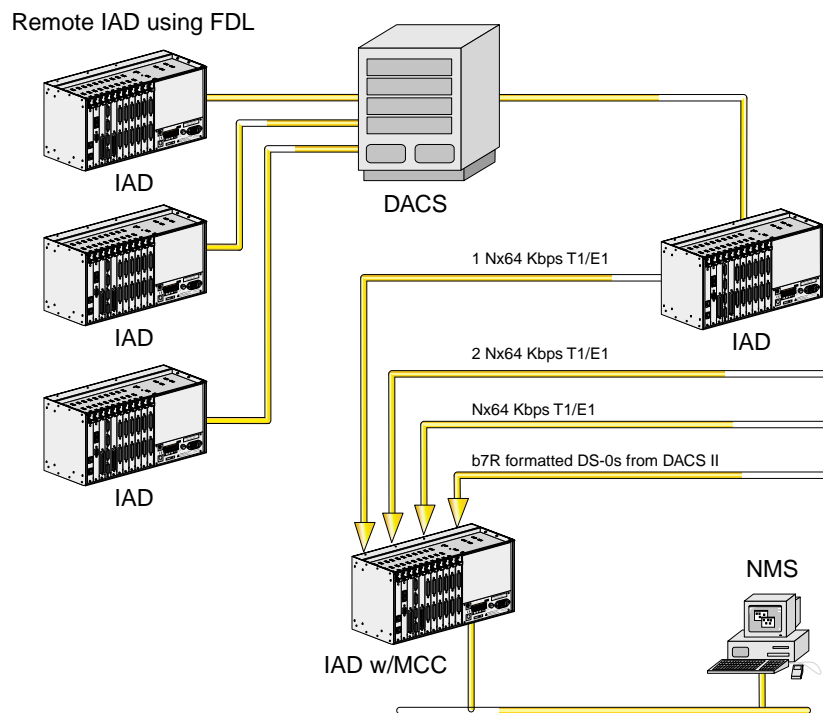

Figure 2-21. MCC Card in a Multilevel Concentration Application

The MCC card performance figure of 3500 packets/second was obtained using 64 byte packets. This implies that for small frames the processor is the bottleneck since the network link cannot be saturated. As the frame size increases, network link utilization becomes higher. For large frames, the network link will become saturated and hence the bottleneck. An equilibrium is reached at frame size of 500 bytes when both the processor and links are saturated.

2.7 Frame Relay Access and Concentration Server

This section highlights the capabilities of the Integrated Access System Frame Relay server card as a cost-effective, efficient, and intelligent high-speed Frame Relay Assembly and Disassembly (FRAD) device and access concentrator in a Frame Relay network. This enables the service provider to deliver Frame Relay and Internet services with a high degree of quality in an economical fashion.

The following is a list of the Frame Relay server card key benefits:

- Highly efficient assembly, disassembly and concentration of Frame Relay traffic allows for significant Frame Relay switch port savings.
- High Frame Relay port density offers significant hardware savings when compared to typical backbone switches making it suitable for deployment at the customer premises. Bringing the frame relay network features closer to the end-user and CO reduces backhaul charges due to efficient use of the frame relay backbone switch port.
- 100% compliance with industry Frame Relay standards enables ready interoperability in multi-vendor networks.
- Support for existing UNI (User to Network Interface) and NNI (Network to Network Interface) standards implies that the frame relay server easily integrates into existing, standards-compliant frame relay infrastructure of the service provider.
- Manageability via SNMP and TELNET eliminates need for separate network management package and offers comprehensive diagnostics for both physical and logical network.
- Complete Support for physical layer diagnostics. In addition, it provides network access for a wide range of devices ranging from high-speed data interfaces (HSU), DDS interfaces (OCU-DP, DS0-DP), IDSL interfaces (BRI), and sub-rate data (FRAD).
- Comprehensive, standards-based congestion management techniques.
- Standards based congestion management ensure interoperability with existing infrastructure and enables the service provider to offer better, more cost-effective Frame Relay services to its subscribers.

The Frame Relay Server can be deployed in the following application scenarios to provide a very cost-efficient and high-quality Frame Relay access to the end-users:

- Frame relay switch port savings
- Frame relay and Internet service provisioning
- IDSL service provisioning
- Grooming and concentration in cellular networks
- Central Office FRAD
- Frame relay concentration at hub sites

2.7.1 Frame Relay Switch Port Savings

Figure 2-22 shows an IAD equipped with one or more Frame Relay server cards that is utilized at the service provider's Central Office to efficiently concentrate multiple lower speed Frame Relay circuits into a consolidated Frame Relay stream into the backbone Frame Relay switch. This results in significant savings in port occupancy on the Frame Relay switch. It is amplified by the fact that these channelized ports on the backbone switches are much more expensive than unchannelized counterparts.

The presence of 68 highly-integrated channelized Frame Relay ports combined with the statistical multiplexing advantages of Frame Relay facilitate the savings by reducing the backbone switch port occupancy by over 2.5 times (67 DS0 circuits instead of 24 DS0 circuits on a single channelized T1 trunk). In a typical case this reduces circuit cost per DS0 by 20%.

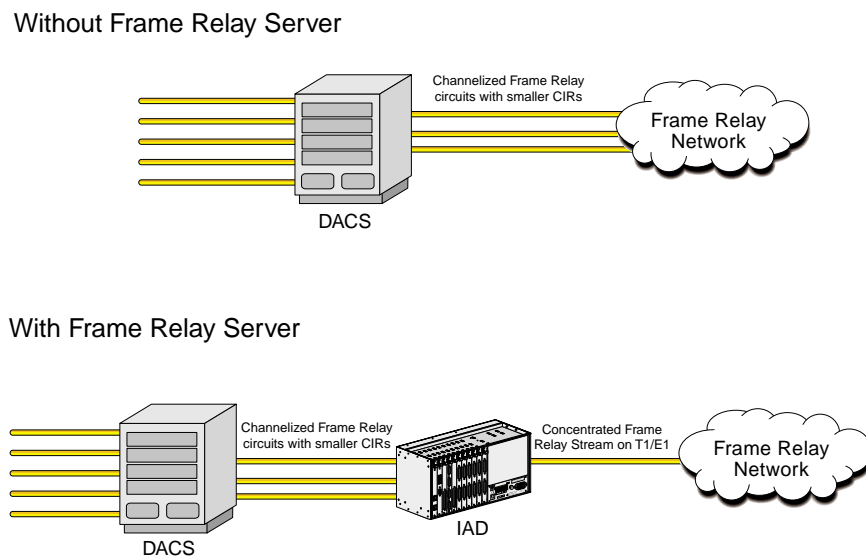

Figure 2-22. IAD using Frame Relay Server Cards

2.7.2 Frame Relay and Internet Service Provisioning

The inherent flexibility of the Integrated Access System platform and the versatility of the Frame Relay server are brought into synergy to provide significant savings to both the service provider and user. An IAD is used as a CLE (Customer Located Equipment) to provide a wide-variety of voice and data services to a multi-tenant premises. The service provider can now add Internet services and native Frame Relay services by simply installing a Frame Relay server in the existing IAD as shown in Figure 2-23. There is no significant addition of new hardware or fork-lifting of existing hardware or complicated provisioning schemes. The Frame Relay Server also provides a PVC backup feature which the service provider can offer as a premium, uninterrupted service to a customer in case the primary link fails.

The cost benefits are realized by the service provider due to:

- Savings in capital expenditure due to minimal hardware upgrades and ease of provisioning. In addition, the remote management capabilities of the IAD and Frame Relay server improve the quality of service delivered thereby lowering costs.
- The high density of logical Nx56/64K ports on the Frame relay server enables very efficient grooming and concentration of Nx56/64K Frame Relay connections to the service provider access links.

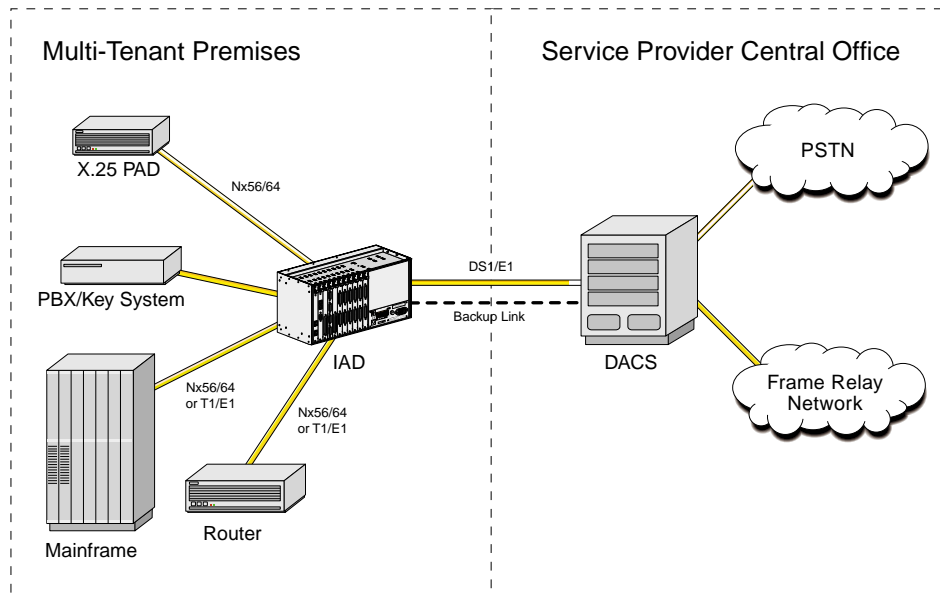

Figure 2-23. Frame Relay and Internet Services using IAD FRAD Server

2.7.3 IDSL Service Provisioning

This Integrated Access System with a Frame Relay server can be used for efficient ISDN DSL (IDSL) provisioning for Internet access at speeds up to 128K. Each BRI card provides up to eight IDSL ports over single twisted pair wire. There can be up to seven such BRI cards in an 800/900 chassis. This arrangement cost-effectively replaces external DDS CSU/DSU equipment and offers higher bandwidth.

Each Frame Relay server supports up to 35 NTUs at 128K over 1 T1 (with 3:1 concentration) or 1 E1 (with 2.5:1 concentration), thereby taking advantage of frame relay's statistical multiplexing capabilities.

Up to 64 DS0s are channelized through the Frame Relay Server ports and are concentrated onto a single port connected to the network. Three concentrator ports bring in additional NXDS0s channels to be concentrated onto the single outgoing port as shown in Figure 2-24.

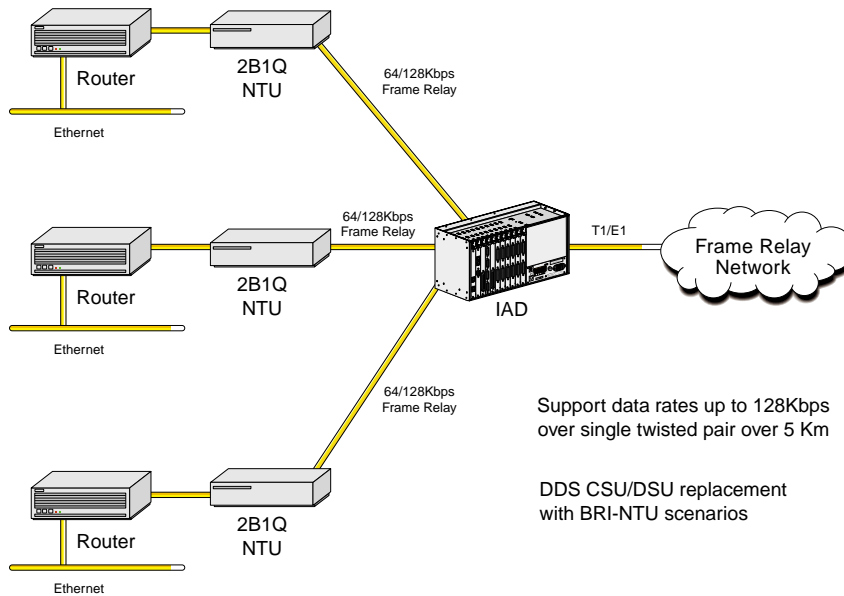

Figure 2-24. IDSL Service Provisioning

2.7.4 Grooming and Concentration in Cellular Networks

Figure 2-25 shows how a remote cell site uses an IAD, trademarked “CellIDAX” for all cellular environment, to transport cellular voice and data traffic to the Mobile Switch Center (MSC).

At the MSC, a DCS directs the CDPD traffic (typically, a single DS0) from each of the 96 cell sites to the IAD at same MCS. Because CDPD uses HDLC framing the traffic from the 96 DS0s can be encapsulated by the two Frame Relay server cards located in the IAD. Each Frame Relay server can take in 64 DS0s directly into ports.

Typically the CDPD traffic is bursty and often less than one full DS0 and so can be groomed and concentrated by the Frame Relay server down to 48 or 24 DS0s depending upon the level of concentration needed. This results in a net savings of two or three T1/E1 spans across the regional MSCs respectively. The MD-IS (Mobile Data Intermediate System) then processes the traffic and routes it to the appropriate destinations.

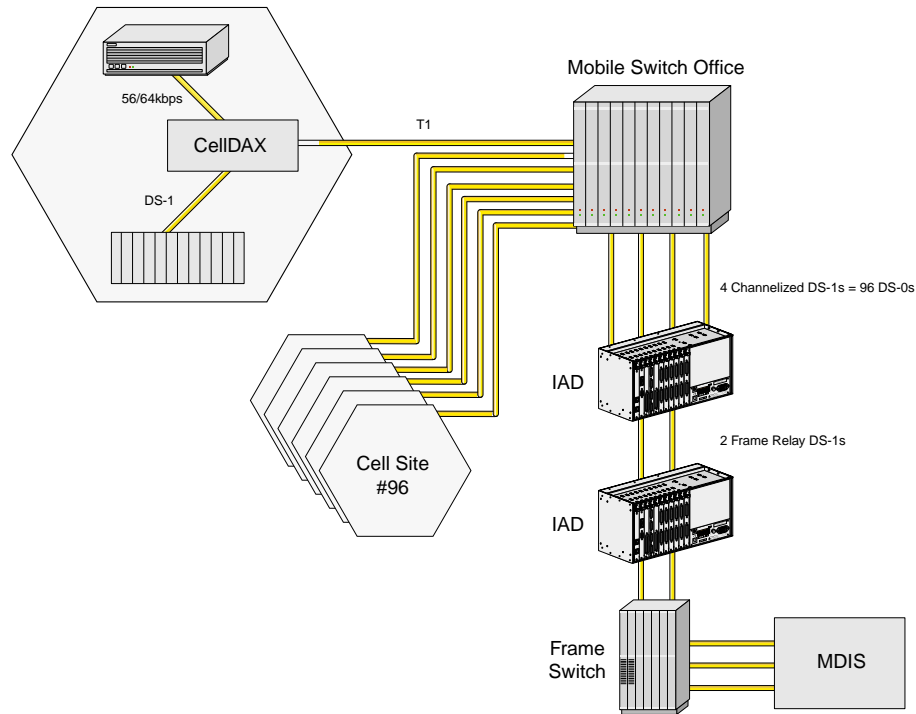

Figure 2-25. Cellular Network Frame Relay Application

2.7.5 Frame Relay Concentration at Hub Sites

In the application shown in Figure 2-26, a corporation which serves a wide geographical area through multiple branch offices is able to utilize the Frame Relay server's ability to consolidate and multiplex multiple NX56/64K circuits into a single high-speed facility. This significantly reduces its access charges from its service provider for its corporate Frame Relay network. Typical examples include banks, health care providers, technology parks, etc.

The branch offices typically subscribe to a Frame Relay service with a Committed Information Rate (CIR) of 56/64K. At the Head Office/Data Center the traffic is typically from a "farm" of front end processors, routers and servers.

Without an IAD+FRS at the Head Office/Data Center, multiple circuits would occupy multiple ports in the service provider's switch and would be tarified for lower individual speeds.

With an IAD+FRS, the multiple lower speed circuits are consolidated and groomed into a single/few high-speed (Nx64K) circuit. Since the marginal access charge of Frame Relay is lower at higher speeds, due to economies of scale, this could reduce costs.

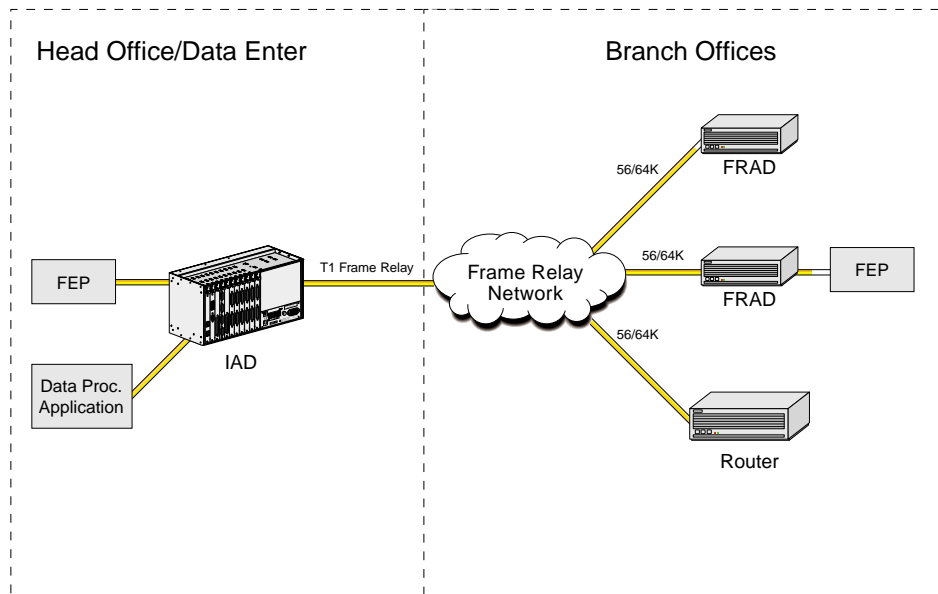

Figure 2-26. Frame Relay Concentration at Corporate Headquarters

2.7.6 Frame Relay Server Specifications

There can be up to three Frame Relay server cards in an Integrated Access System chassis in non-redundant operation. The Frame Relay Server performance figure of 4000 Frames/Second was obtained using 64 byte frames. The following hardware and firmware must be included in a system to add Frame Relay Server operation:

- 880360 CPU Control Card with 8 T1/E1 Cross Connect (redundant-capable)
- 892260/892261/892360/892460 - 8 T1/E1 Interface card w/ 128K NVRAM
- 881360 Advanced Communication Server (ACS) with 131 logical ports
- 60500 or above Host Firmware version 5.x
- 63180 - ACS Frame Relay Server firmware

2.8 ATM Server Card (882060)

Although ATM is being touted as an ubiquitous technology for all business communications services, the reality is that it is playing a significant role so far only in backbone campus network for LAN applications for local transport. This section highlights the benefits of the various applications of the 882060 ATM Server card and demonstrates how it can effectively and efficiently to deploy various services. The ATM Server Card provides the ability to provision legacy voice, data, and video services over an ATM backbone via a DS3.

The ATM Server card includes support for efficient, standards-based ATM adaptation of a multitude of legacy traffic types. Examples include analog key systems, routers, video codecs and PBXs. Legacy traffic is directed from T1, E1, data and voice interfaces to the ATM Server, which then provides ATM adaptation and encapsulation. By providing direct, integrated connectivity to the ATM network, the system eliminates the need to run parallel networks for ATM and TDM traffic. The ATM Server Card is based on standards adopted by the ATM Forum and the ITU. These standards allow the ATM Server to inter-operate with a wide variety of ATM switches and to adapt multiple traffic types for aggregation and transmission across an ATM network. Some of the well-known switches include those from FORE, Lucent, NORTEL, GDC, ADC Kentrox (also listed in a following slide).

Since the ATM Server Card fits in any server slot, service providers can deploy the Integrated Access System in non-ATM access networks today, and easily migrate to ATM based access by simply adding an ATM Server Card. The ATM Server Card, combined with the wide range of interfaces on the system, provides the most flexible platform for service provisioning in the market today. The following is a list of the ATM server card key benefits:

Standards-based ATM adaptation for voice, video, and data

This feature enables the Integrated Access System to adapt the traffic from a wide variety of legacy interfaces to ATM. Therefore there is no need to upgrade or replace existing equipment while migrating to ATM solutions. This results in significant savings in capital expenditure. Interoperable with deployed ATM switching equipment such as ADC Kentrox, Fore Systems, Lucent, etc.

This is a key selling point of the ATM server. Because of its interoperability with already deployed ATM switching equipment, it can be easily added with minimal costs when the MIS manager wants to collapse parallel ATM and TDM networks into a single ATM network. When an ATM network is installed, typically there is excess bandwidth and port capacity that behooves such a merger of networks. For instance, when an ATM switch is deployed each line card will have multiple ATM ports out of which only one or two may be used for data traffic. The Integrated Access System w/ ATM server can be connected to the unused port(s) thereby consolidating other legacy traffic on to the ATM network. This results in significant cost savings for the customer since there is only one as opposed to two networks to be managed.

Provides DS0 granularity for virtual circuit input

By providing DS0 granularity, the ATM server is able to direct individual lower speed voice and data circuits to unique destinations through out the ATM network. This is accomplished without “burning up” multiple physical ports on the ATM switches which are expensive. The ATM server’s highly efficient and cost-effective aggregation of lower speed CBR and VBR virtual circuits makes this possible.

Supports constant and variable bit rate adaptation

By supporting constant and variable bit rate services, the ATM server tailors the adaptation to best suit application requirements for quality of service (QoS). E.g., typically voice and video applications require constant guaranteed bandwidth and stringent delay constraint and are modeled as CBR traffic. Data, compressed voice and video are amenable to variations in bandwidth and delay requirements and are modeled as VBR traffic.

Manageability via SNMP and TELNET

SNMP and TELNET manageability eliminates need for a separate Integrated Access System network management package. The system and its components can be managed from the same existing network management device that manages the ATM backbone and other devices.

The ATM server is deployed in the following application scenarios to provide a very cost-efficient and high-quality ATM service to the end-users:

- Interactive Distance Learning/Tele-Medicine
- Legacy Adaptation to ATM
- Analog PBXs/Key Systems
- Digital PBXs
- Nx56K/64K Data terminal equipment
- Video Codecs
- Transparent LAN Extension

2.8.1 Legacy Adaptation to ATM

The addition of the ATM Server card further extends the capabilities of the integrated access platform by efficiently provisioning a multitude of legacy services for transportation over an ATM network as shown in Figure 2-27.

There are still many legacy services (PBXs, key systems, video codecs etc.) which need a parallel TDM network to operate since they are not “ATM-ready.” Two parallel networks drive up the cost of installation, operation and maintenance. Since businesses have very significant capital investment in these legacy systems and processes they cannot justifiably be fork lifted and replaced by equivalent “ATM-ready” equipment. Furthermore, when a new ATM campus network is deployed, typically there is excess bandwidth and port capacity that is under utilized. What needs to be added is a cost-effective product for adaptation of all these legacy services to ATM. This would enable connecting a multitude of “non-ATM ready” equipment to the ATM network.

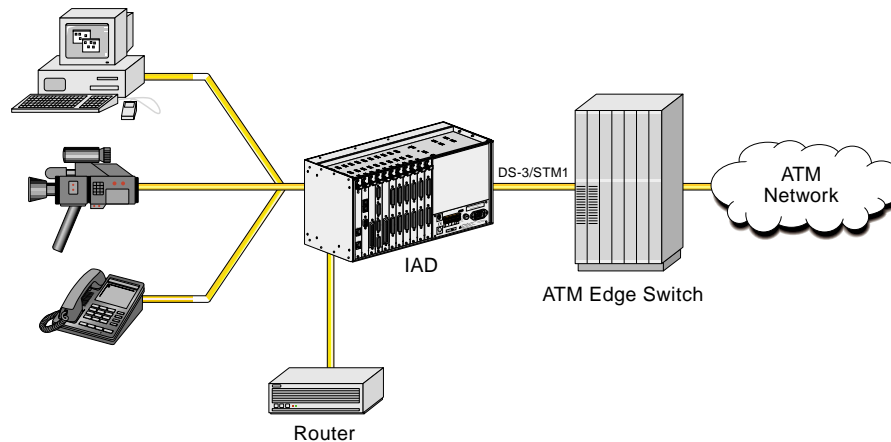

Figure 2-27. Migrating Legacy Networks to ATM

2.8.2 Interactive Distance Learning/Tele-Medicine

The Integrated Access Systems' integrated multi-service capabilities supports interactive distance learning applications where the central site and the major educational centers are connected through an ATM network and the remote sites are accessed via leased T1/E1 lines.

The video stream (TDM traffic) from the central site is adapted to ATM by the ATM server and multi-cast to the sites on the ATM network as shown in Figure 2-28. The ATM servers located at the Major University locations convert the video from ATM to TDM traffic and pass it on to remote sites over leased T1/E1. The ISDN PRI server is utilized in conjunction to connect the remote sites to the video conferencing network over T1/E1 leased lines. The entire network is managed from a central network management system.

The same network structure is deployed effectively in a Tele Medicine application in which doctors from central medical centers can exchange patient information, X-rays etc. with remote hospitals and provide remote diagnosis.

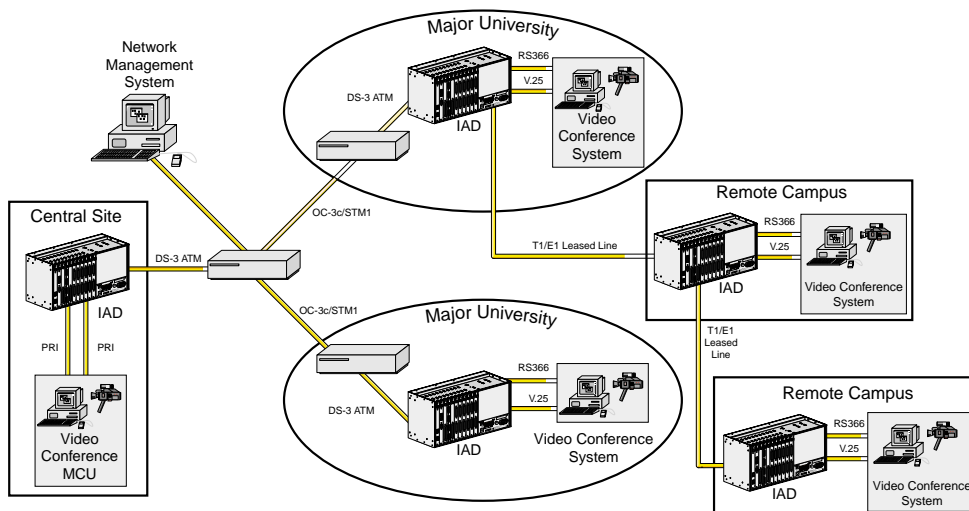

Figure 2-28. Interactive Distance Learning Application

2.8.3 ATM Server Specifications

Up to three ATM server cards can be functional in an Integrated Access System in a non-redundant configuration. The ATM Server card performance figure of 4000 Frames/Second was obtained using 64 byte frames. The following hardware and firmware must be included to add ATM Server operation:

- 880360 CPU - Control Card with 8 T1/E1 Cross Connect (redundant-capable)
- 892360/892460 - 8 T1/E1 Interface card w/ 128K NVRAM
- 882060 - ATM Server card with 1 DS3 ATM UNI port
- 60500 or above Host Firmware version
- 64140 - ATM Server Firmware

2.9 Routing Server

The IP Routing Server enables the Integrated Access System to act as a gateway router to the Internet via bundled service deployment or in private Intranet network deployment. Specifically, the primary market for the IP Routing Server is Internet access via bundled service arrangements (integrated access). The bundled service marketplace is simply the provisioning of multiple services over a single T1 or E1 to a customer. Typical bundled service arrangements include local voice service, long distance service and a data service. Internet access is one of the possible data services. The potential market for this technology is quite extensive. There are over 6.5 million small business in the US, and about 1.3 million of these

have 6 to 20 phone lines. These businesses are prime candidates for bundled service arrangements. Carriers are aggressively targeting this market, as they strive to out position one another with integrated business telecommunications solutions.

The Integrated Access System platform is unique in that it possesses many of the qualities listed below in a flexible form factor. As equipment and technologies mature, there is a constant requirement to consolidate communications equipment for many reasons, including:

- lower capital costs
- integrated management
- ease of use and installation
- remote connection efficiency

2.9.1 Bundled Service Deployment

The IP Routing Server is targeted at performing boundary routing functions for access to Internet or Intranet based services. The standard application for an IAD in this environment is in bundled service arrangements where the IAD is utilized to integrate voice circuits and an Ethernet-based Internet port at the customer location as shown in Figure 2-29. The carrier would typically switch the voice circuits to the PSTN via a DACS, while the frame relay based data connection from the Ethernet port would be connected to a Frame Relay network for transmission to the Internet. An external firewall can be used for providing and maintaining security when connected to the Internet.

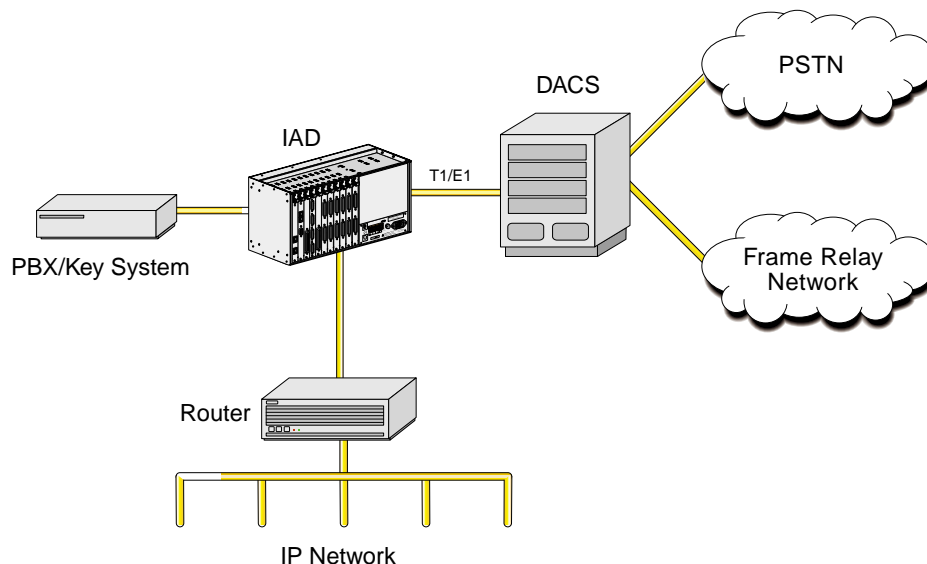

Figure 2-29. IP Routing Server for Internet or Intranet Based Services

2.9.2 Private Intranet Deployment

A secondary market for the IP Routing Server is private Intranet access. In the application shown in Figure 2-30, remote site A is connected to a private WAN. The remote site has a single connection to a centralized router, which provides full IP routing functionality. The IAD on the right has two T1 connections, one to each of the two remote IAD, and one connection to the router. Normally, there would be two connections to the router. However, in this application, the IAD on the right includes a Frame Relay Server card which switches both frame relay streams into the router.

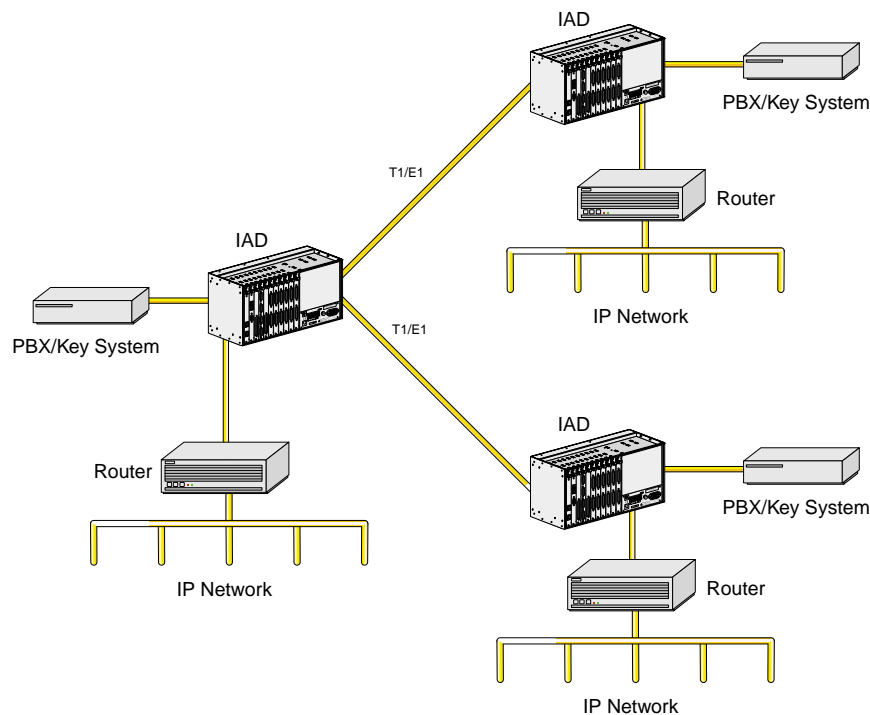

Figure 2-30. Private Intranet Deployment using IP Routing Server Card

2.9.3 IP Routing Server Specifications

Up to three IP Routing server cards can be functional in an Integrated Access System in a non-redundant configuration. The processor performance figure of 3500 packets/second was obtained using 64 byte packets. The following hardware and firmware must be included in an Integrated Access System to add IP Server operation:

- 880360 - CPU Control Card with 8 T1/E1 Cross Connect (redundant-capable)
- 892360/892460 - 8 T1/E1 Interface card w/ 128K NVRAM
- 881161- Advanced Communication Server (ACS) with 3 WAN ports

- 60500 or above Host Firmware version
- 67130 - IP Routing Server firmware

2.10 Low-Bit Rate Voice Server (830060)

The 830060 **LBRV** (Low Bit Rate Voice) Server card allows for the compression of 64Kbps digital voice channels into 8Kbps (plus overhead) digital sub-channels, and subsequently for the sub-channels to be multiplexed over one, two or three composite Wide Area Network (WAN) links. The LBRV Server can accept voice inputs from either analog voice ports (such as FXS, FXO, E&M) or from T1/E1 WAN links through the Integrated Access System.

Each LBRV / ACELP voice compression server card supports up to three composite links at speeds of 64k, 128k or 192k. The composite links are comprised of HDLC frames on one, two or three time slots. Users assign voice channels to one, two or three links based on the need to switch those channels separately through the network. The composite links can be routed directly to WAN cards or to the Frame Relay Server. When routed to a Frame Relay Server (FRS), the FRS provides a FRAD function for the compressed voice frames. No Frame Relay sub-addressing is supported, so all voice channels within each composite link from the ACELP will be treated as a single PVC.

In a single Integrated Access System, there are 32 voice ports which can be compressed but is dependent on whether the voice channels originate on analog cards, or a total of 64 ports can be compressed on WAN time slots.

The LBRV card performs DTMF recognition and re-construction. This means the integrity of DTMF does not suffer from the compression/decompression processes. The LBRV card does not support MF signaling between switches. The following is a list of the LBRV key benefits:

- Simple topologies including Point-to-point, Star, Mesh.
- LBRV performs a compression and transport function. It does NOT perform voice switching and call-routing.
- High density of channels and high volume of traffic.
- LBRV solution is competitive with high volumes of traffic. There should be many (24+) voice channels in one location.

High reliability in mission-critical installations

LBRV is suited to carrier networks and service organizations where down-time is unacceptable. Examples include call centers, help desks, and inter-exchange trunks. LBRV offers high reliability through:

- Hardware redundancy
- Environmental ruggedness

- No moving parts
- Path redundancy (with FRS). It can be achieved through Backup PVC feature which switches to an alternate path upon either Loss of LMI (loss of FR administration connection) or WAN CGA alarm (T1/E1 failure)

Carrier networks requiring specialized Telco interfaces

This Integrated Access System has specialized telco interfaces found in carrier environments such as:

- Coin phone (12/16 kHz or battery reversal)
- 64 kbps G.703 co- / contra-directional
- BRI & PRI ISDN voice
- T1 and E1 interface

This Integrated Access System is equipped with the LBRV Server card which offers cost-effective applications including:

- Bulk voice compression for remote call center
- Back-hauling voice for new carriers (e.g. centralized voice mail)
- Extending voice access network over VSAT

2.10.1 Call Center Application

In the application shown in Figure 2-31, customer calls originating from the PSTN are compressed by the LBRV server for efficient transmission on the leased E1 trunk. up to Up to three LBRV servers are used per IAD to compress up to 192 voice channels from the PSTN on to the E1 link and still leave 128Kbps bandwidth for data traffic from a router. A Frame Relay server is used in the IADs' at the hub locations to send voice and data traffic on the leased E1 trunk.

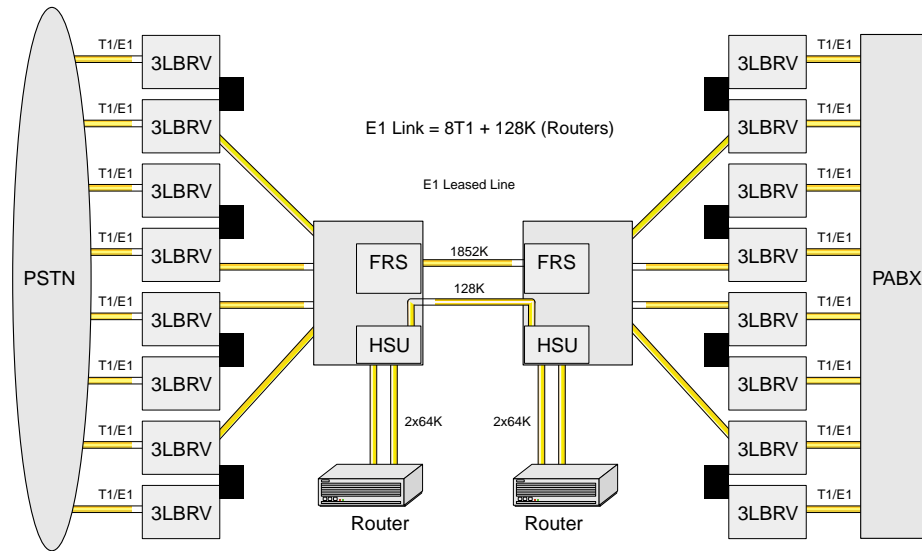

Figure 2-31. LBRV in a Call Center Application

2.10.2 Backhauling Voice Application

The Integrated Access System equipped with a LBRV server can be used by new wireless carriers who need to lease Telco facilities between their geographically separate Mobile Switching Centers. They can use the LBRV server shown in Figure 2-32 to see the leased link very efficiently thereby reducing hauling costs.

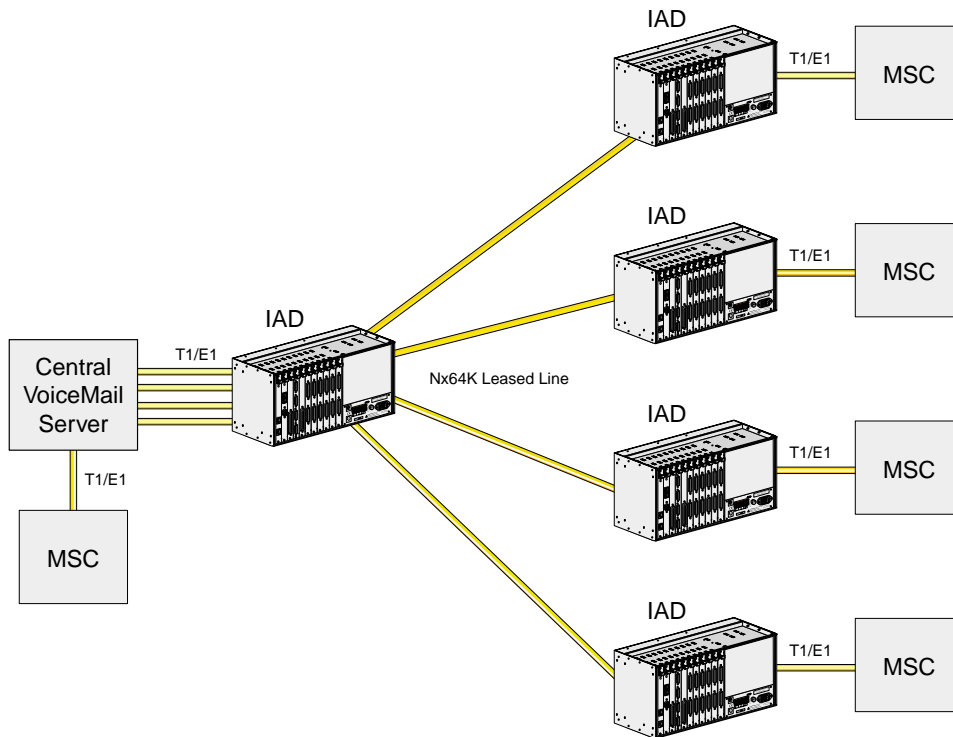

Figure 2-32. Backhauling Voice Application

2.10.3 Extending Voice Access Application

The application shown in Figure 2-33 is similar to the previous one where the LBRV is deployed to utilize the lower-speed but expensive VSAT link very efficiently.

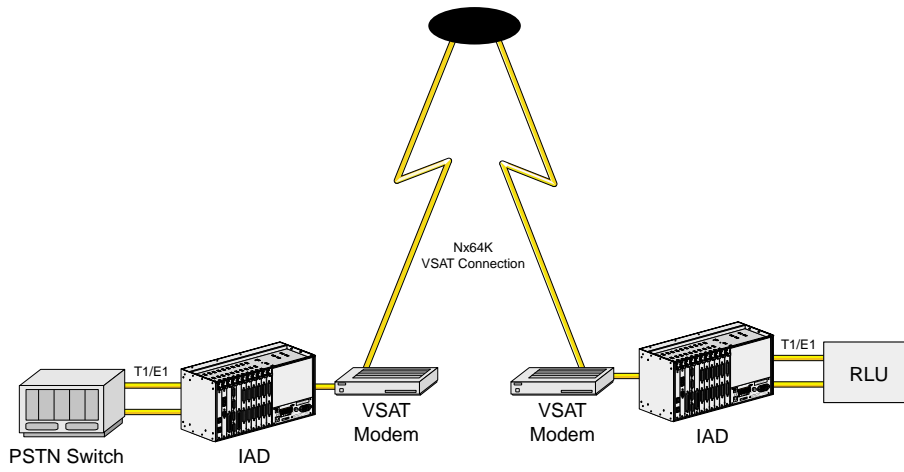

Figure 2-33. LBRV Voice Access Application

Chapter 3

System Installation

3.1 Introduction

This chapter provides instructions for unpacking and installing the Integrated Access System chassis and plug-in cards at the user site. It also includes other information you will need to properly install the system and refers you to other chapters for additional card-level information.

The system can operate on either AC or DC power when equipped with the proper power supply. Refer to the system specifications section in this manual regarding electrical and environmental requirements.

3.2 User-Set Switches and Jumpers

Several plug-in cards of the Integrated Access System contain on-board switches and/or jumpers. Some cards also require you to install sub-modules for proper operation. You must prepare these cards before inserting them into the chassis.

3.3 Chassis Installation

3.3.1 Unpacking the Chassis and Cards

The Integrated Access System chassis and cards are packed separately. When you receive your system, unpack the boxes and check the contents for damage. If anything is damaged, contact the shipping carrier to file a claim. The carrier representative will also tell you how to submit a claim, where to send the unit, and give you any special instructions you may need.

Pack the damaged item in its original packing materials and send it by prepaid freight to the address you received. If the original packing materials are unavailable, pack the unit in a sturdy box and surround it with shock-absorbing material.

3.3.2 Pre-Installation Tips

3.3.2.1 Installation Checklist

Install your Integrated Access System in the following sequence:

1. Choose a suitable location for the system, as described in this chapter.
2. Unpack and inspect the equipment for damage.
3. Mount the chassis on the desired surface (rack, tabletop, or wall).
4. Install the chassis ground connections.
5. Set the chassis jumper for U.S. or European operating voltage compliance.
6. Remove the power supply covers from the chassis.
7. Install the AC or DC power supplies.
8. Install an AC-to-DC converter (if necessary).
9. Install a ringing generator (if necessary).
10. Verify the voltage ratings of all power supplies in the chassis.
11. Verify the fuse ratings of the source power supply.
12. Install a CPU card.
13. Install the Interface card.
14. Install the WAN cards.
15. Install server cards, as required.
16. Install the user (voice, data, and alarm) cards, as required.
17. Install the power supply covers on the chassis.
18. Apply power to the system and verify the power LED states.

After successfully installing the system, configure the system for operation as follows:

1. Connect a VT100-compatible terminal to the Interface card.
2. Log into the system, then register.
3. Set the Alarm Filters.
4. Configure the CPU card.
5. Configure the Interface card.
6. Configure the WAN cards.
7. Configure all other cards.

3.3.3 Choosing a Location for Your System

The Integrated Access System requires a reasonably dust-free, static-free operating environment, such as a computer room. Adequate ventilation is also required at the site. Do not install the chassis in direct sunlight, which may increase the system's operating temperature and affect its operation.

Most of the system plug-in cards have highly sensitive components that could be damaged by static electricity. Whenever you handle any system cards, be sure to observe local electrostatic discharge (ESD) precautions.

The mounting brackets supplied with the chassis are needed for tabletop installation. The top and bottom of each chassis also must be clear of objects to ensure proper air flow through the chassis.

The system chassis can be installed on an 19-inch or 23-inch equipment rack, attached to a wall, or placed on a tabletop or other level surface. First though, make sure the desired surface can support the weight of a fully equipped chassis.

The system specifications section in this manual lists the maximum power consumption of each system card. Use this table to calculate the total system power consumption.

The system specifications section in this manual also lists some typical current measurements for each card at all DC operating voltages.

Be sure to locate the system near all external equipment to which you will connect it. Cable lengths and physical/electrical characteristics are critical to system operation, especially for data signal interfaces. Generally, higher data rates require shorter cables than lower data rates.

Also, you must use T1-grade or E1-grade cables for all system connections to those networks. For best results, use the cables supplied by your supplier when connecting your system to the associated external facilities. For more information on system cabling, call your supplier.

3.3.3.1 Rack Installation Tips

When installing the chassis in a rack, allow at least 2 inches (5.1 cm) of space between the chassis and the equipment above and below it for proper ventilation. Use the mounting brackets and attachment hardware furnished with the chassis for this purpose, as outlined in the next section. If you use other mounting hardware, you may damage the chassis or circuit boards installed in it.

Also route all cables to their destinations through conduits to enhance electromagnetic compatibility (EMC) performance and facilitate future system troubleshooting. When routing cables, be sure not to obstruct any chassis vents.

3.3.3.2 Wall-Mount Installation Tips

To mount the chassis on a wall, first obtain a piece of standard, marine-grade plywood (3/8 inch diameter, typical) and bolt it firmly to the desired mounting surface. This board must be long and wide enough to cover the entire chassis length and height. The surface must be able to support the total weight of the system (chassis plus plug-in cards).

3.3.3.3 Tabletop Installation Tips

The chassis should be placed on a flat, smooth surface (e.g., a table) that is free of contaminants. This surface should be capable of supporting a fully equipped chassis. Be sure to allow enough clearance above and below the chassis for proper air circulation. You must use the metal brackets and feet furnished with the chassis for this purpose.

3.3.4 Installing the Chassis

3.3.4.1 Front-Loading Chassis with Power Supplies on Side

The front-loading chassis with power supplies on the side has eight holes on each side, as shown in Figure 3-1. These holes are for mounting in a standard 19-inch or 23-inch rack (48.2 or 58.4 cm). The holes labeled “T” on the bottom are for tabletop mounting.

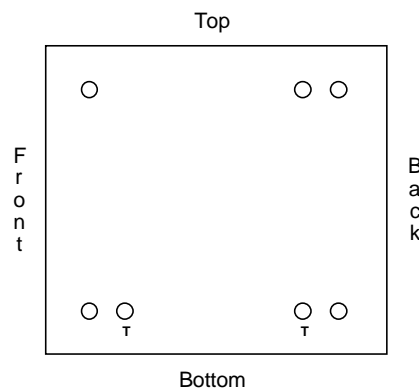

Figure 3-1. Mounting Holes for Front-Loading Chassis with Power Supplies on the Side

Figure 3-2 shows the mounting bracket holes. To mount the chassis in a rack, first attach the brackets to the sides of the chassis, using the four associated 10-32 x 1/4" screws. You can attach the brackets to either the front or rear of the chassis. Then, use the four 12-24 x 1/4" screws to mount the bracketed chassis on the rack.

The brackets are also reversible for mounting in 19-inch or 23-inch racks (48.2 or 58.4 cm). For a 19-inch rack, attach the long sides of the brackets to the chassis. For a 23-inch rack, attach the short sides of the brackets to the chassis.

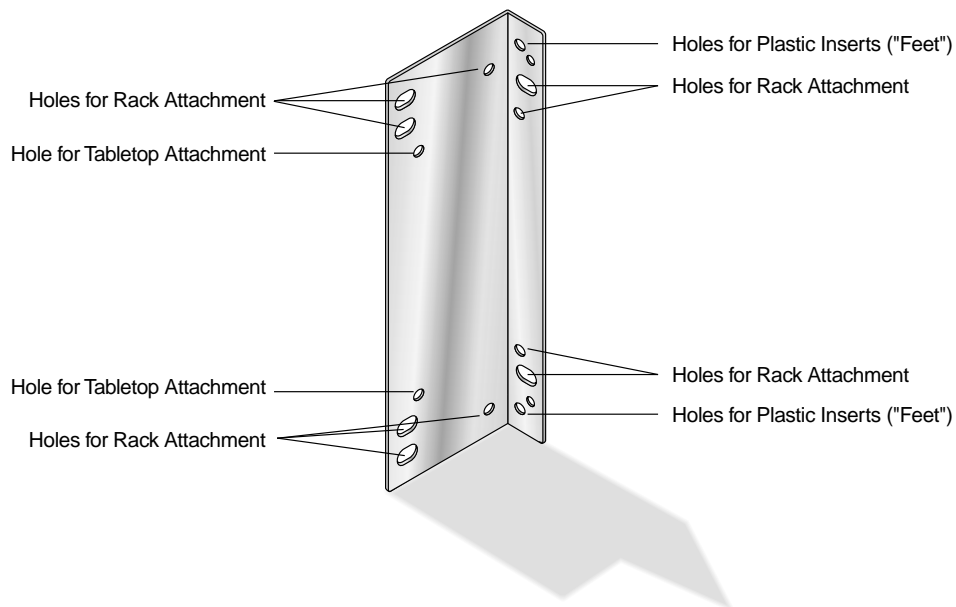

Figure 3-2. Mounting Bracket Holes

If you are placing the chassis on a tabletop or other flat surface, be sure to leave enough clearance for air circulation through the system. Make sure the chassis is accessible from the front, and that it has at least 3/4 inches (2 cm) of room above it. Attach the metal brackets to the chassis sides. Then, insert the plastic abrasion-protective "feet" in the holes near the ends of the bracket.

3.3.4.2 Front-Loading Chassis with Power Supplies on Top

The front-loading chassis with power supplies on top also has eight holes on the bottom of each side, as shown in Figure 3-3. Attach the mounting brackets of Figure 3-3 to these holes on each side of the chassis, in order to mount the chassis in a 19- or 23-inch rack. Or, attach the brackets to the two holes on the bottom of the chassis for mounting on a tabletop or other flat surface.

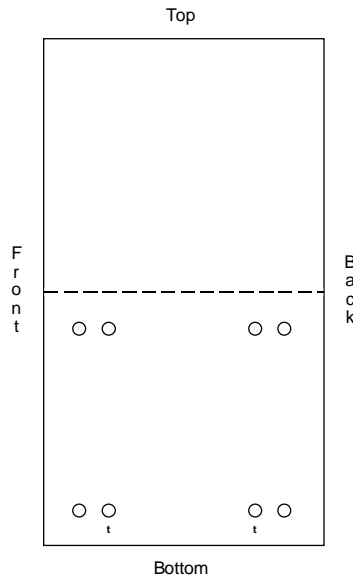

Figure 3-3. Mounting Holes for Front-Loading Chassis with Power Supplies on Top

3.3.4.3 Two-Sided Chassis

The two-sided chassis have 12 holes on each side, as shown in Figure 3-4. These holes facilitate mounting in a 19- or 23-inch rack (48.2 or 58.4 cm). You can attach the front, middle, or rear of this chassis to a rack, using the mounting brackets as previously shown for the front-loading chassis with power supplies on the side. To place a two-sided chassis on a tabletop, attach the mounting brackets to the two holes on the bottoms of the chassis sides.

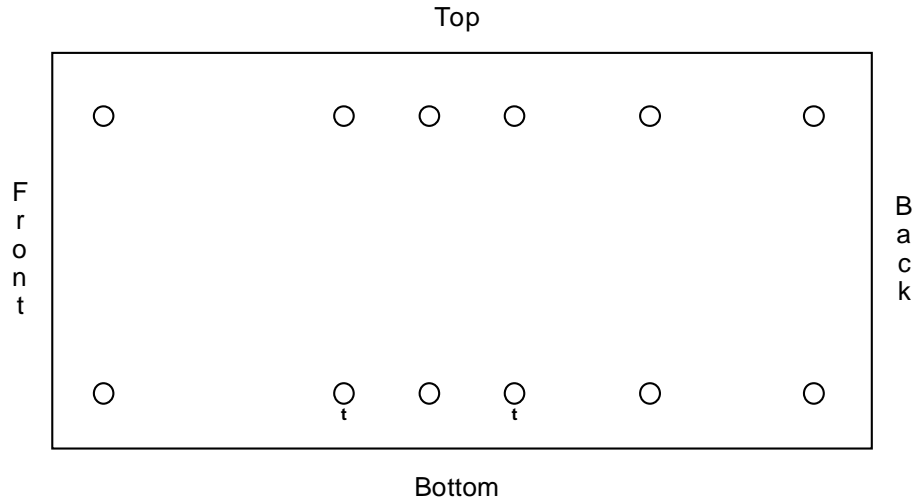

Figure 3-4. Two-Sided Chassis Mounting Holes

Be sure both the front and rear of the chassis are accessible for inserting and removing cards. The voice, data, and WAN cards, and the power cables, are attached to connectors at the rear of the chassis. Table 3-1 lists the minimum clearances required between the system chassis and the nearest objects.

Table 3-1. Minimum Two-Sided Chassis Clearances

Clearance	Front	Rear	Top	Bottom
Inches	10	15	3/4	2
Centimeters	25	38	2	5

3.4 Power Supplies and Ringing Generators

The power supply and ringing generators (8901, 8902, 8903, 8905, 890620 and 8908) system can consist of up to two power supplies, two AC-to-DC converters, and up to five ringing generators. External -48V talk battery and ringing generators may be used instead of the internal units. Use the following guidelines to determine your power supply and ringing generator requirements.



Note: The 8908 unit can only be installed in the 891930 chassis.



Note: When a 300 Watt power converter (8908) is required, there is no need to use a ringing generator unless there are analog voice cards installed in the system. If a ringing generator is required, it can be placed in one of the other, non-contiguous slots. (e.g., 300 Watt power converter in slot HP1 and ringing generator in slot R2).

3.4.1 System Power (Redundancy)

The system always requires a 120/240 VAC, -48 VDC, or 24 VDC Power Supply. For backup, you may add a second identical power supply.



Note: Even though the 24 VDC supply has specifications listed as positive throughout this manual, it can be used with a negative voltage (-24V). Because of the extremely small number of applications that would require -24V, it is not covered in this manual.

3.4.2 -48V Talk Battery Requirements

Talk battery is required whenever you have voice user cards in the system, unless (a) all of those are E&M cards and are used in the Transmission-Only mode, or (b) Type 1 E&M signaling is used. A -48 VDC power source is also required for use with the ALR 4+4 or ALR 4+3PF External Alarm Cards, OCU-DP cards, and to provide sealing current for BRI cards. The -48 VDC talk battery can be provided from an external source, or by using a 115 VAC to -48 VDC Converter. This unit is only available for 115 VAC sources. A similar AC-to-DC Converter is also available for use with either 115 or 220 VAC.

3.4.3 Setting the U.S./European Configuration Jumper

Before inserting any cards into the chassis, set its JP1 jumper for either the U.S. or European configuration. This jumper is shown in Figure 3-5; it is on the resource card backplane and is accessible from the chassis front. The default jumper setting is **US** (for systems in the U.S. and Canada). To change the chassis electrical configuration for European compliance (**EUR**), move the jumper to pins 2 and 3.



Figure 3-5. JP1 Jumper Settings

Also be sure to set the jumper on the system resource cards and external alarm cards to agree with the above setting for the chassis. Refer to the associated chapters in this guide for information on those card jumpers.

3.4.4 Installing the System Power Cards

Next, install power supplies, AC-to-DC power converters and ringing generators into the system chassis as described in this section. However, do not apply power to the system until you finish installing these cards, AND after making the power and ground connections to the chassis as described in the next section of this chapter.



CAUTION!

Failure to follow the procedures mentioned above will result in damaging the boards.

3.4.5 Talk Battery Supply Fuses

The fuse for the DC Power Supply is in a removable cartridge next to the DC input socket on the front or rear panel (depending on which chassis you may have). The power supply should have a 5Amp fuse on it. Refer to the system specifications section in this manual.

3.4.6 AC Power Supply and DC Power Supply Fuses

The AC power supply and DC Power Supply fuses are already built in to the supplies. When unpacking the unit a power cord will be in the box. The AC inlet connector is located in the front or rear of the chassis. Refer to the system specifications section in this manual.

3.4.7 Installing AC or DC Power Supplies

To install the AC or DC power supply in a chassis, first remove the panel covering the front power slot. Then, hold the power supply by its metal handle and align the printed circuit board (PCB) edges with the rail guides of either power supply slot. Push the unit in until it is firmly seated in the backplane connector, and replace the panel cover. For redundant power supplies, also insert a second AC or DC power supply into the adjacent slot.

When the AC or DC power supply is installed and power is applied, the green LED on the front panel of the power supply should light. A problem exists if this LED does not light. Verify that the power supply is properly seated in the connector. Also check the external power source and connections to the power supply. If the power supply is properly seated, and the external power source and power connections are operational, replace the power supply. Replace the panel cover.

3.4.8 Installing the -48V Converters (8903/8905/8908)

To install a -48V Converter in a chassis, proceed as follows. Refer to the system specification section in this manual for the -48V Converters. Figure 3-6 shows the location of the fuse on the converter board.

1. For a two-sided chassis, remove the panel covering the rear power slots. You may insert or remove the module in any of the five rear slots while power is on or off. For a front-loading chassis, remove the panel covering the front power slots. You may insert or remove the panel while power is on or off.
2. Hold the converter by its metal handle and align the PCB edges with the slot rail guides in the chassis. Gently push the converter in until it is firmly seated in the backplane connector.
3. When the power converter is installed and power is applied, the green LED on the front panel of the converter should light. A problem exists if this LED does not light. Verify that the power converter is properly seated in the connector. If so, also check the external power source and connection to the power supply. If the power converter is properly seated, and the external power source and power connections are operational, replace the converter.
4. Replace the panel cover.



Note: The 8908 unit can only be installed in the 891930 chassis.



Note: There are two different types of 100W -48V Converters; one with full range and one with limited. 8903 - 120V only, 8905 - 120/240V.

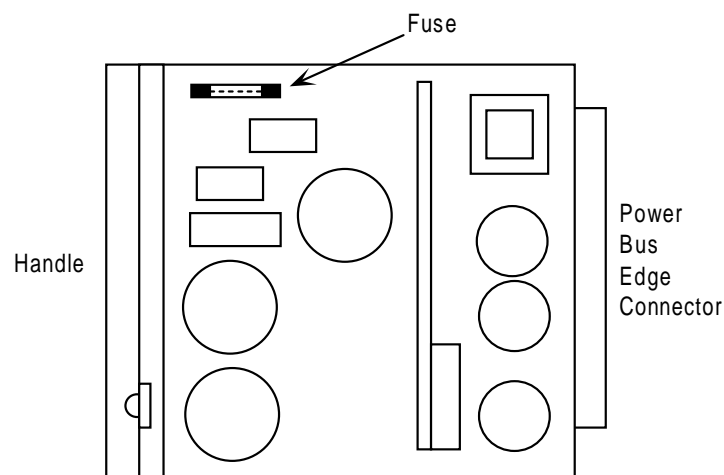

Figure 3-6. -48V Converter Fuse

3.5 Ringing Generators

The ringing generator provides a ringing voltage of 105 VAC (nominal) at 20 Hz for simultaneously ringing 11 voice ports. If more than one ringing generator is required in the same chassis, they must have the same model number. **Ringing Generators cannot be mixed with 8906 and 890620 in a single chassis.**

Make sure the system uses a -48V power source before installing any ringing generators. You can install up to four ringing generators in a two-sided chassis, depending on the availability of its slots. The front-loading chassis can have only one ringing generator each.

When two or more ringing generators are used, the outputs of all ringing generators are linked together by OR circuits on the ringing bus. One generator must be jumpered as the MASTER and the others must be jumpered as SLAVES. The master ringing generator then synchronizes the ringing signals on the ringing bus. Refer to the system specification section in this manual for the ringing generators.

3.5.1 Ringing Generators (8906/890620)

Ringing generators are needed if the system has FXS or FXS-C cards, or if it has FXO or FXO-C cards with ports connected to Manual Ringdown (MRD) circuits. The 20 Hz ringing voltage may be provided either by an external source or with a Ringing Generator, which requires the presence of -48 VDC in the system. **Ringing Generators cannot be used in conjunction with external ringing sources.**

The ringing generators provide a ringing voltage of 105 VAC at 20 Hz for 11 simultaneously ringing voice ports. Since most systems will not have that much activity, a single Ringing Generator might provide all of the power necessary to run the system. In a group where incoming calls are at a minimum, 30 to 50 stations could share the same ringing generator. Small groups with heavy incoming call volumes might require two or more Ringing Generators. This condition should alert you to the need for additional equipment.



CAUTION!

Do not mix 8906 and 890620 Ringing Generators in the same chassis.

The compatibility of power sources used together are summarized in the system specification section in this manual.

3.5.2 Installing the 105V Ringing Generator (8906/890620)

To install a 105V Ringing Generator, proceed as follows:

1. **Make sure power is turned off before inserting the ringing generator (8906 only).** The 890620 may be installed with power applied (“Hot swapping”). The 890620 ring generator has improved operating efficiency resulting in lower operating temperatures which promote a longer life expectancy and support of more analog voice ports per ring generator. It also provides inrush current control during start-up allowing for hot insertion (plugging) without disrupting the Integrated Access System power supply busses.
2. Make sure jumper W201 is installed if this is the only ringing generator in the unit, if it is the MASTER ringing generator, refer to Figure 3-7. If this is a SLAVE ringing generator, cut jumper W201 with wire cutters.
3. For a two-sided chassis, remove the panel covering the rear power slots. You can insert the generator into any of the five rear slots. For the front-loading chassis with power supplies on top, remove the panel covering the front power slots, and insert the module in any of the five slots. For the front-loading chassis with power supplies on the side, insert the ringing generator only into slot R1.

4. Hold the unit by its metal handle and align the PCB edges with the slot rail guides in the power supply backplane. Gently push the unit in until it is firmly seated in the backplane connector.
5. If the power supply is installed and power is on, the LED on the front panel of the ringing generator should illuminate green. A problem exists if the LED is not illuminated. Verify that the MASTER/SLAVE settings are correct, and that the unit is firmly seated in the connector. If so, replace the ringing generator (it is faulty).



Note: In previous releases the ringing generator LED flickered, indicating a functioning unit.

6. Replace the panel cover.

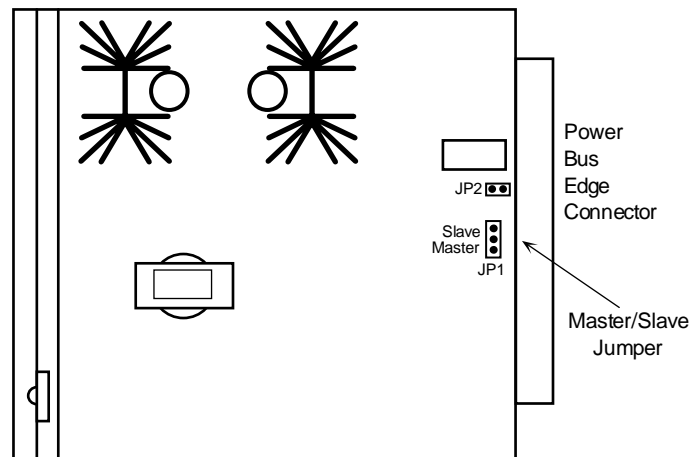

Figure 3-7. 105V Ringing Generator Jumper Setting

3.6 System Power and Ground Connections

After installing the system power cards into the chassis, make the power and ground connections to the chassis as described in this section. Each chassis has a terminal strip for the DC voltage, ringing generator, and ground connections.

3.6.1 Front-Loading Chassis with Power Supplies on the Side (891630)

Figure 3-8 and Figure 3-9 shows the AC and DC power and ground connections to a front-loading chassis with power supplies on the side.

Connect the grounds and DC power signals to this terminal block by inserting the wires (max. 14 gauge wire) in the proper slots, then tightening the screws adjacent to the slots to secure the connections. For safety reasons, no more than one-eighth inch (0.125") of each connecting wire should be exposed. **No uninsulated wire should be visible from the terminal block.**

The power terminal block also provides dual power connections at V_A and V_B where redundant power feeds are required. The V_A pins feed power supply slot S1, and the V_B pins feed power supply slot S2.

In addition, you can connect the V_N pins of the block to an external -48V source for powering voice cards and their circuits. The **COM** (common) pin is the systems digital ground connection, and the **RGR** (ringer) pin is for connecting an external 20 Hz ring generator input to the chassis. The ringing voltage bias is selected by a connection to V_{N+} or V_{N-} .

When operating from a DC source, a protective earth ground must be connected to the "Protective Earth/Chassis Ground" (\oplus) terminal block location. When operating from an AC source, this connection is made through the power cords "third wire" ground.

If your system will be connected to voice circuits that use E&M or FX ground-start signaling, connect the chassis ground terminal to the same chassis ground used by the external PBX or other system. Tying the chassis grounds together will ensure proper signaling operation and transmission between the two ends of each circuit.



Note: If -48 VDC is applied to V_A or V_B . DO NOT connect external power to V_N .

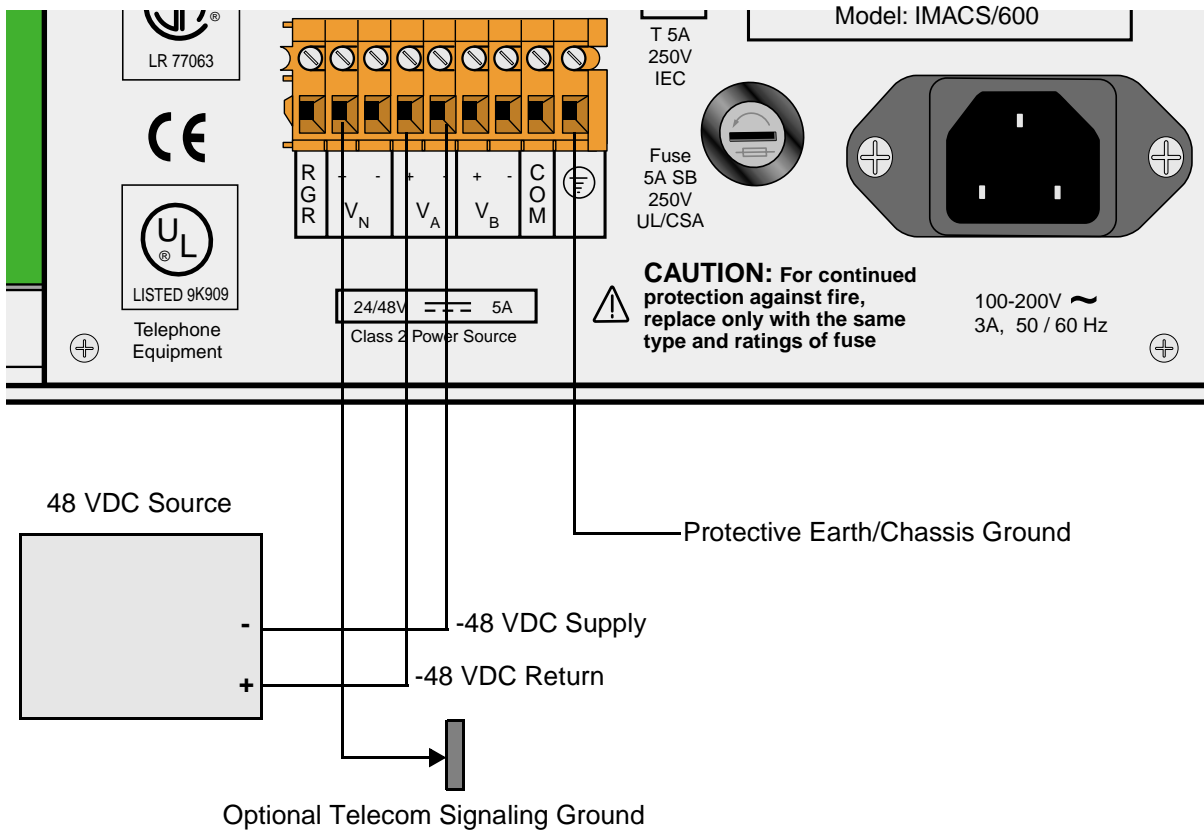

Figure 3-8. DC Terminal Block on Front-Loading Chassis with Power Supplies on the Side in a DC Environment



Note: *Optional Telecom Signaling Ground* - It may be required when the -48 VDC source output is not referenced ground or when the system is AC powered. It is only needed for the proper operation of the Telecom Ground Start and E&M signaling circuits.

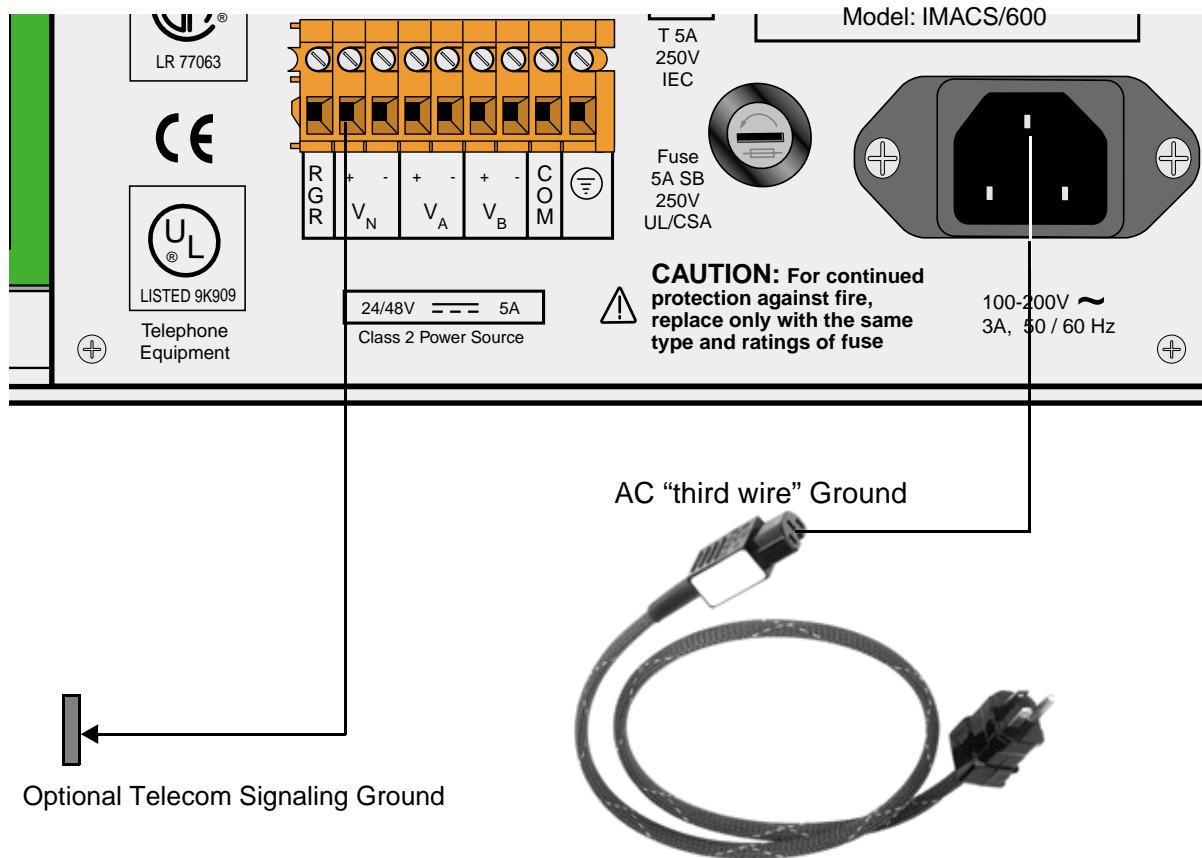

Figure 3-9. AC Power Connector on Front-Loading Chassis with Power Supplies on the Side in a AC Environment



Note: The AC “third wire” ground is connected to the system’s protective earth lug, located inside the system chassis.

3.6.2 Two-Sided Chassis (891830)

Figure 3-10 shows the DC power connector block on the two-sided chassis with power supplies on the side. Figure 3-11 shows the AC power connector block for the same chassis.

Connect the grounds and DC power signals to this block by inserting the wires in the proper slots, then tightening the screws adjacent to the slots to secure the connections. For safety reasons, no more than one-eighth inch (0.125") of each connecting wire should be exposed. **No uninsulated wire should be visible from the power connector block.**

The power connector block also provides dual power connections at V_A and V_B where redundant power feeds are required. The V_A pins feed power supply slot F1, and the V_B pins feed power supply slot F2.

In addition, you can connect the V_N pins of the block to an external -48V source for powering voice cards and their circuits. The **COM** (common) pin is for a signal ground connection, and the **RGR** (ringer) pin is for an external 20 Hz ringing input to the chassis. The ringing voltage bias is selected by a connection to V_{N+} or V_{N-} .

When operating from a DC source, a protective earth ground must be connected to the "Protective Earth/Chassis Ground" (\oplus) terminal block location. When operating from an AC source, this connection is made through the power cords "third wire" ground.

If your system will be connected to voice circuits that use E&M or FX ground-start signaling, connect the chassis ground terminal to the same chassis ground used by the external PBX or other system. Tying the chassis grounds together will ensure proper signaling operation and transmission between the two ends of each circuit.



Note: If -48 VDC is applied to V_A or V_B , DO NOT connect external power to V_N .

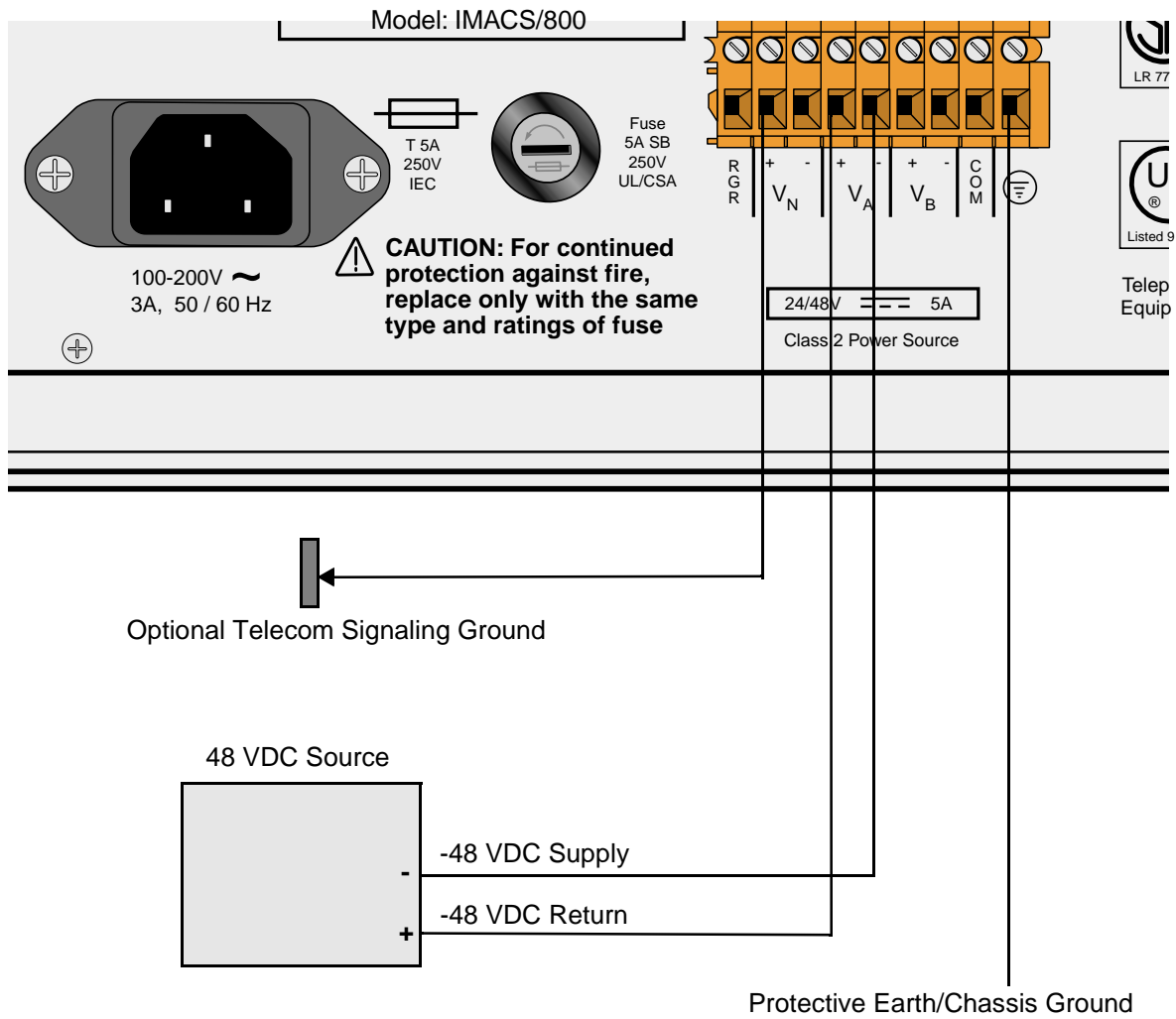

Figure 3-10. DC Terminal Block on Two-Sided Chassis with Power Supplies on the Side in a DC Environment



Note: *Optional Telecom Signaling Ground - It may be required when the -48 VDC source output is not referenced ground or when the system is AC powered. It is only needed for the proper operation of the Telecom Ground Start and E&M signaling circuits.*

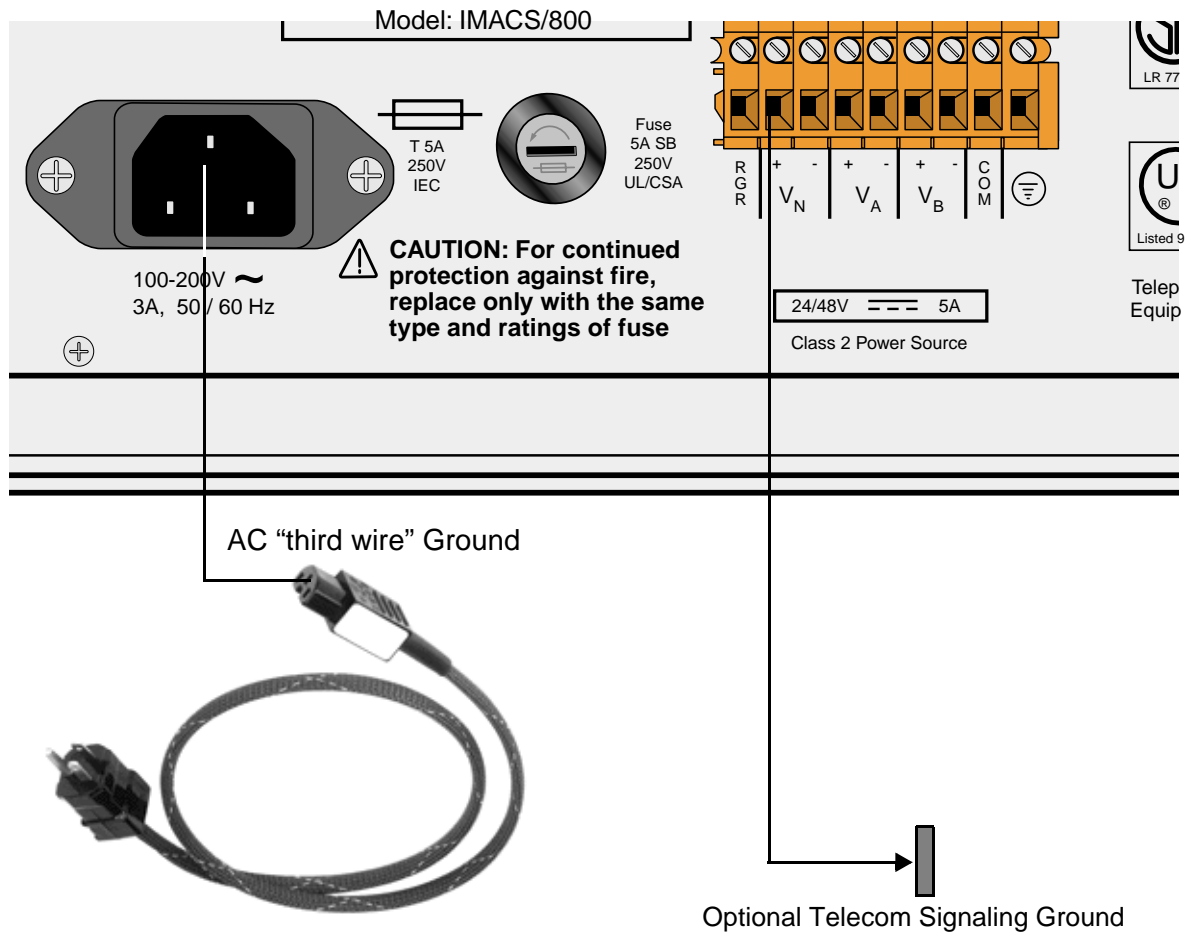

Figure 3-11. AC Power Connector on Two-Sided Chassis with Power Supplies on the Side in a AC Environment



Note: The AC "third wire" ground is connected to the system's protective earth lug, located inside the system chassis.

3.6.3 Power Enhanced Chassis with Power Supplies in Front (891930)

Figure 3-12 shows the terminal block on the front-loading chassis with power enhancement on top. Although the terminal block is oriented vertically on this chassis, it provides an improved external terminal block that requires additional jumpers to provide power to user cards that apply voltage to the CPE device.

The V_{NA} and V_{NB} leads were added to provide an interface for a separate, redundant or non-redundant power source to the system. The V_{NA} and V_{NB} leads are no longer referenced to the V_A and V_B leads respectively. As a result this condition if you are running a DC system with -48VDC connected to the V_A (F1 Power Supply) or V_B (F2 Power Supply) leads, you will not have any battery applied to any of the user cards that require the -48VDC towards the CPE equipment. There must be a separate source applied to the V_{NA} or V_{NB} leads to provide the -48VDC source to the connecting CPE equipment. If a second source is not available you may install a jumper from the V_A or V_B source leads using 16 gauge wire. The V_A or V_B source feed must also be 16 gauge wire if a jumper between leads is required.

The telecommunications voice signaling ground is referenced ground connection to the V_{NA+} side or V_{NB+} side of the -48VDC power system. Both of these feeds are referenced to the same place on the backplane. This reference ground can occur at the Integrated Access System power connection strip or at the -48VDC power source, which ever is more effective if having multiple connections back to a ground source is not desirable. The wire connection between the V_{NA+} , V_{NB+} , V_{A+} , or the V_{B+} terminals, and a referenced ground is required to eliminate ground isolation between connection devices. **If this ground connection is not maintained, and one side of the connection equipment is not referenced to an earth ground then a floating ground condition can occur causing the voice circuits and the voice signaling to react erratically when either end of the connecting equipment tries to start the circuit.**

When running the system in an AC environment with an AC/DC converter installed in the chassis, the V_{NA+} or V_{NB+} must have the same ground reference as the connecting equipment so as not to produce a floating ground potential as discussed earlier.

Sites using only loop start telecommunication circuits (no ground start or E&M signaling) can operate properly without the Telecom Signaling Ground.

When grounding the system, use 14 gauge solid wire for a single connection to the terminal block connector. When there is no way to provide multiple separate ground feeds use 16 gauge solid wire to connect from one terminal block pin to another terminal block pin with a ground feed on one of the terminal block pins that are looped together. If you use different gauge wire on the feed terminal block pin and the looped terminal block pins the connection may not have the proper integrity due to the larger size wire impeding a solid connection to the smaller wire.

In all previous versions, the chassis and ground was either tied together via the terminal block connector or when the logic cards were inserted and secured with the panel screws. This caused the ground scheme of the system to be automatically tied together via the logic card.

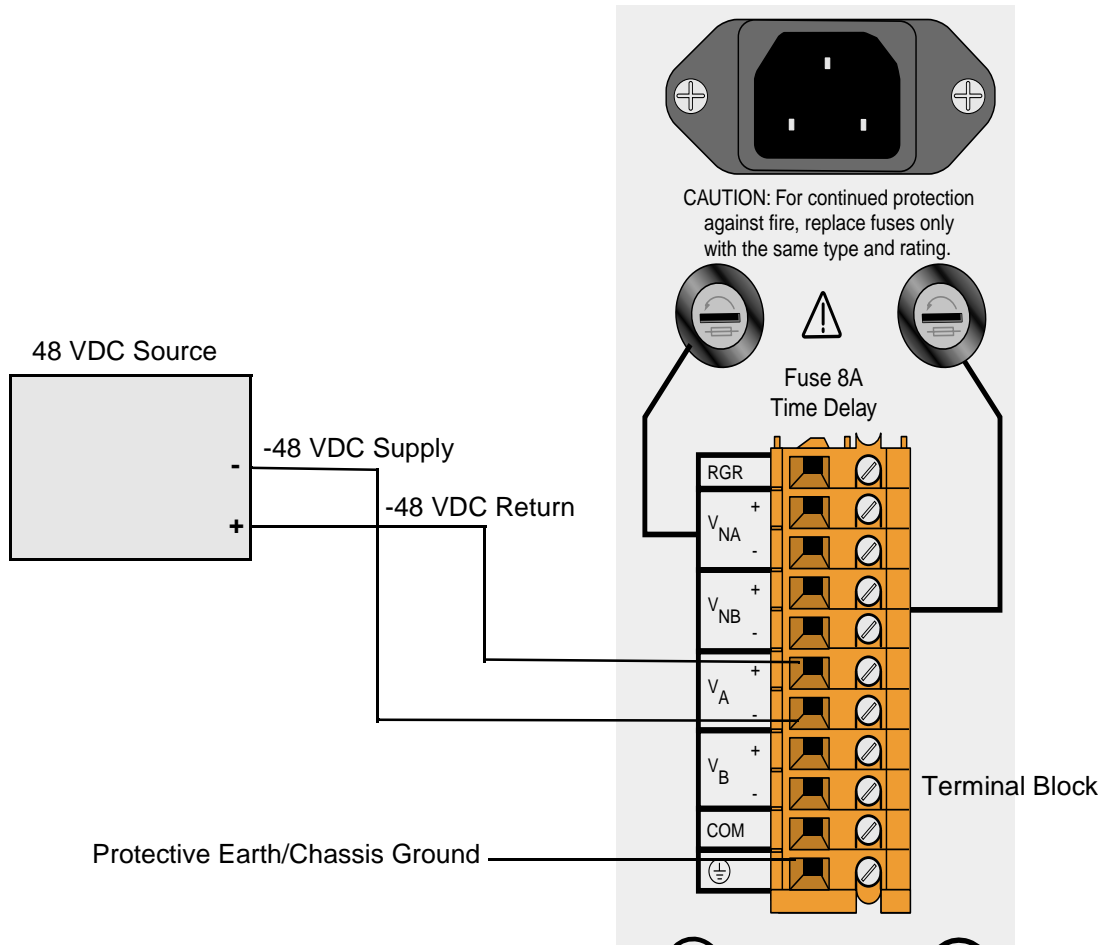

Figure 3-12. DC Terminal Block on Enhanced Chassis with Power Supplies on Top in a DC Environment with one Power Source



Note: The diagram above only depicts one DC power source which would support the F1 power supply. If a redundant power configuration is desired, then a second power source would be applied to the V_B (+ & -) leads. A separate feed is not required to the V_{NB} (+ & -) leads unless a redundant feed is preferred.

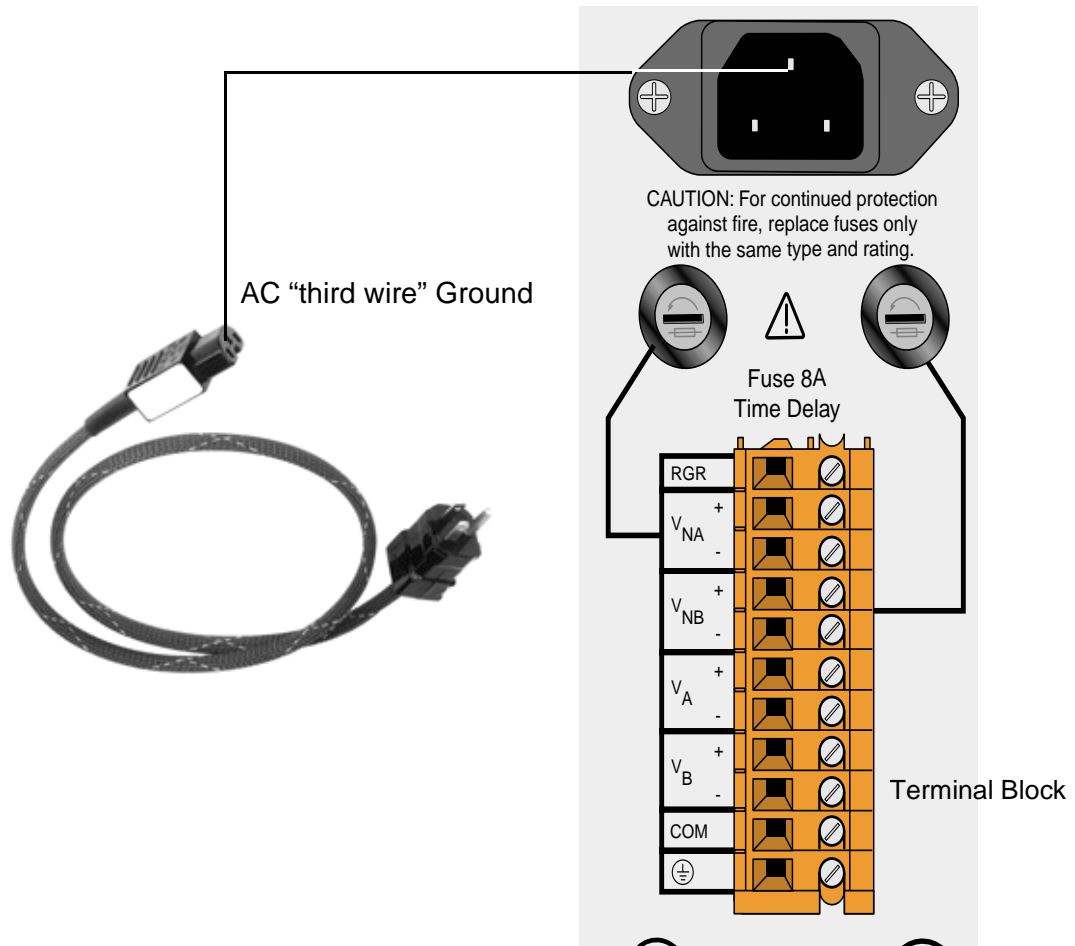

Figure 3-13. Power Enhanced Chassis with Power Supplies on Top in an AC Environment with an -48VDC AC/DC Converter for Voice or Data Applications

3.7 Powering Up the System

After connecting the chassis to the external power sources and making the proper ground connections, apply power to the chassis. Plug the AC power cord into the associated electrical outlets, or turn on the external DC power supply. Then, observe the following front-panel LEDs:

1. The green power LED is lit on the power supply faceplate. If redundant power supplies are used, this LED is lit on both cards.
2. If AC-to-DC converters are installed, their green power LEDs light.
3. If the ringing generator is installed and power is on, the LED on the front panel of the ringing generator should illuminate green.

If these LEDs are not lit, first verify that the external power source is providing power to the chassis, and check the connection between that source and the chassis. Also be sure each card is firmly seated in its chassis slot.

If AC-to-DC converters are used, also check their jumper settings as previously described. If all of these conditions are met, replace the card on which the green LED fails to light; that card is faulty.

3.8 Installing the Other Plug-In Cards

Install the remaining cards into their designated chassis slots.

Some cards have on-board switches or jumpers that you must set before insertion into the chassis. These cards and their settings are summarized at the beginning of this chapter. Also refer to the associated card reference guides for detailed instructions for each card.

3.8.1 Interface Cards (892260 / 892360 / 892460)

Install an Interface (INF) Card (892260, 892360 or 892460) into the IF slot of the chassis. Only one INF card is used in each system. This card provides the connections to the external user interface control systems, alarm reporting facilities, and T1 and/or E1 networks and system docking.

3.8.2 CPU Card (880360)

Install a CPU-5 XCON Card into slot C1 of the system chassis. If redundant CPU cards are used, also insert an identical card into slot C2. Refer to the CPU section in this manual for details. After installing these cards, verify that the green LEDs illuminate on their faceplate. If the yellow LEDs illuminate instead, check to see if the CPU card is registered. If the yellow LEDs are still illuminated, replace the associated cards.



Note: The Host Code in the CPU only recognizes the first four digits of any card. For instance 812960 will display 8129 on the screen.

3.8.3 WAN Cards (800060 / 801060 / 801160 / 801460 / 801560 / 802060)

Install the Wide-Area Network (WAN) Cards (800060, 801060, 801160, 801460, 801560, or 802060) into the W1 through W4 chassis slots. But, each system can have up to four WAN cards. Each card also requires the proper type of sub-modules (T1 DSX/E1 CEPT, T1 CSU, Adtran E1/HDSL and PairGain T1/HDSL), depending on whether it interfaces with a T1, E1 or DSL network. Refer to this manual for more information on the various WAN cards currently available.

After installing the WAN cards, verify that the green LEDs illuminate on the WAN faceplates. If their yellow LEDs light instead, check that the T1s are active. If the yellow LEDs are still illuminated, replace the associated cards.

3.8.4 Server Cards

The Integrated Access System offers various types of server cards, including ADPCM (8871), FRS (881160), MCC (881360), ATM (882060), ISDN-PRI (884060), PRI-BRI (881162), IMUX (8880) and IPR (881161, 883060 and 883160). Each system can have up to three server cards, which fit in slots P1, P2, and P3 of the chassis. Refer to the Server Card Reference Guide for more information on these and other server cards available with this system.

When installing server cards into your system, note that some are labeled “ACS” on their faceplate ejectors, regardless of the type of service they provide. This label identifies the actual card itself, which is physically the same for some server applications. However, an ACS card can be individually software-configured as a frame relay server (FRS), management channel concentrator (MCC), asynchronous transfer mode (ATM) server, or PRI-BRI server. Therefore, the specific server type for each card (FRS, MCC, ATM, ISDN-PRI, PRI-BRI, IMUX, IPR, etc.) appears only in the user interface screens, which are described in the Server Cards Reference Guide.

3.8.5 User Cards

The system also has numerous user cards for connections to voice and data circuits at the CPE, and alarm cards for system alarm reporting to/from external facilities. The user cards go in slots U1 to U8 of the two-sided chassis and front-loading chassis with power supplies on top. Or, they go in slots P1 to P4 and W1 to W4 of the front-loading chassis with power supplies on the side.

You can install up to seven user cards into a front-loading chassis with power supplies on the side. If you have this chassis type, you must reserve one of the “W” or “P” slots for either a WAN card or a server card.

3.8.6 Connecting Cables to the Cards

After inserting the cards into the system chassis, connect them to the external equipment, using the proper cables. The cards have various types of connectors on their faceplate for those connections.

Some cards have 50-pin Amphenol-type jacks on their faceplate. To connect a cable to this type of jack, first plug the male connector of the cable into the jack and push it in all the way. Then, tighten the mounting screws above and below the cable connector.

For modular (RJ-11 and RJ-48) jacks, push the cable’s mating plug into the jack until it snaps into place. However, do not try to force the plug into the jack.

For DB-9 and DB-25 jacks, first plug the cable’s mating connector firmly into the jack. Then, thread the screws on either side of the cable connector into the standoffs above and below the card jacks, and hand-tighten them.

Refer to *Appendix C. Pinouts* in this guide for more information on the associated card jacks and signal pinouts.

Chapter 4

System Configuration and Operation

4.1 Basic Operations

This chapter provides instructions for configuring the Integrated Access System for operation after installing it at the equipment site.

Before performing the procedures in this chapter:

1. Be sure your Integrated Access System is installed and powered up.
2. Determine your system's specific configuration requirements. These depend on your network and customer premises equipment (CPE) interfaces. If this configuration information already exists, obtain it from your system administrator or engineers.
3. Obtain a terminal with VT-100 or VT-102 emulation and an RS-232 to RJ48 cable for these procedures. The terminal will be connected directly to the TERM port on the Interface card in your system. It allows you to access the system and then configure it for operation with your network and CPE.

4.2 Basic Screen Map and Legend

To make system access, configuration and testing easy, the system presents you with a series of user interface screens. Each screen displays various fields of information, and you can change the data in those fields as required by your system and external interfaces.

4.3 System Initialization

System initialization consists of registering your system then logging into it for additional configuration. These operations are described on the following pages.

4.3.1 Registration

To register your system after starting it up for the first time, proceed as follows:

1. Be sure your system and local terminal are both powered up.

2. Connect a VT100-compatible terminal to the TERM jack on the Interface card front panel. Use a cable with an RJ-48 modular plug on one end for this connection.
3. Configure the terminal to operate at 9.6 kbps, 8 data bits, no parity, and 1 stop bit.
4. Press the RETURN key. The Registration Screen in Figure 4-1 appears.

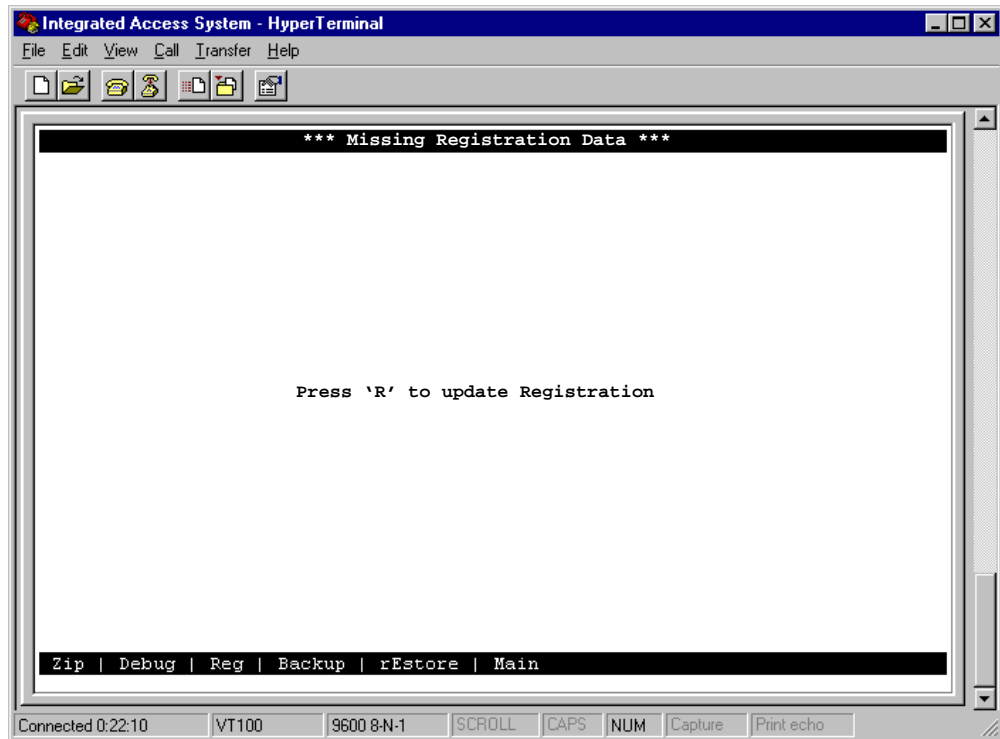

Figure 4-1. First Time Registration Screen

5. Press “R” to update Registration.
6. Enter password as shown in Figure 4-2. Refer to Table 4-1 for default passwords and access level, press the <Enter> key.

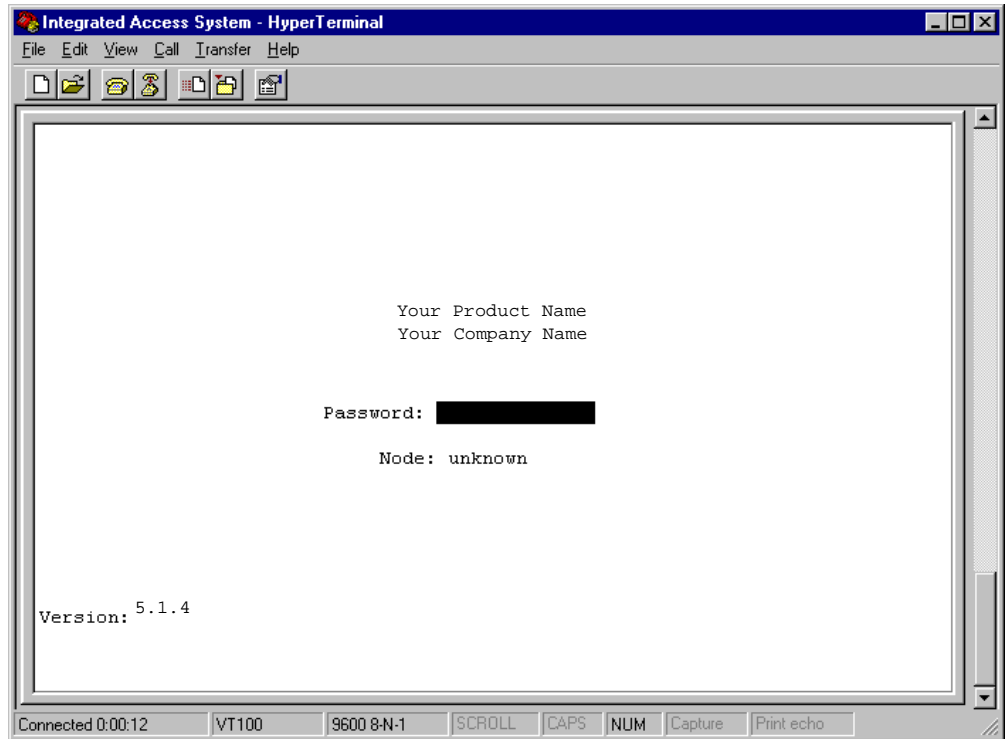

Figure 4-2. First Time Login Screen

7. Enter your vendor code in the Vendor Code field. See Figure 4-3 below, press the <Enter> key.

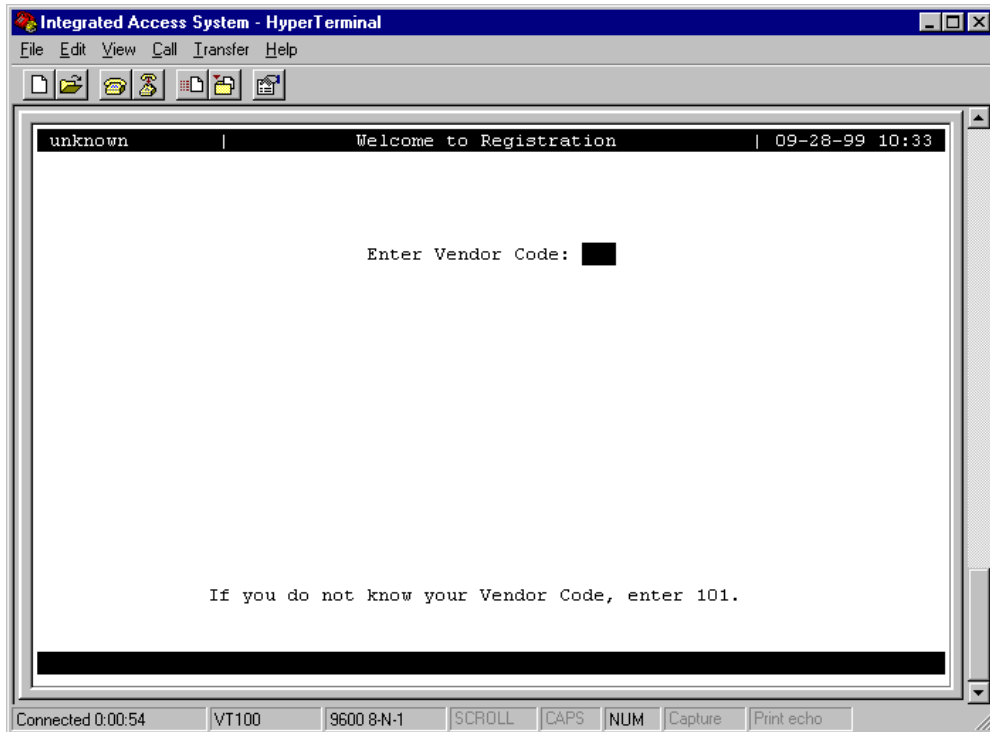

Figure 4-3. Welcome to Registration Screen

The Vendor Code for this Integrated Access System is given in a registration sheet that is usually packaged with the Power Supply Cover panel.

8. Select the type of chassis used (front-loading with power supplies on the side, front-loading with power supplies on top, or front/rear loading with power supplies on the side).
9. If the vendor code and chassis types selection are both correct, type **Y** to confirm and save that data. Otherwise, type **N** to return to the screen for changes.

The system now automatically restarts with the correct application parameters. Proceed to the next section, log into the system, and start configuring it for operation.

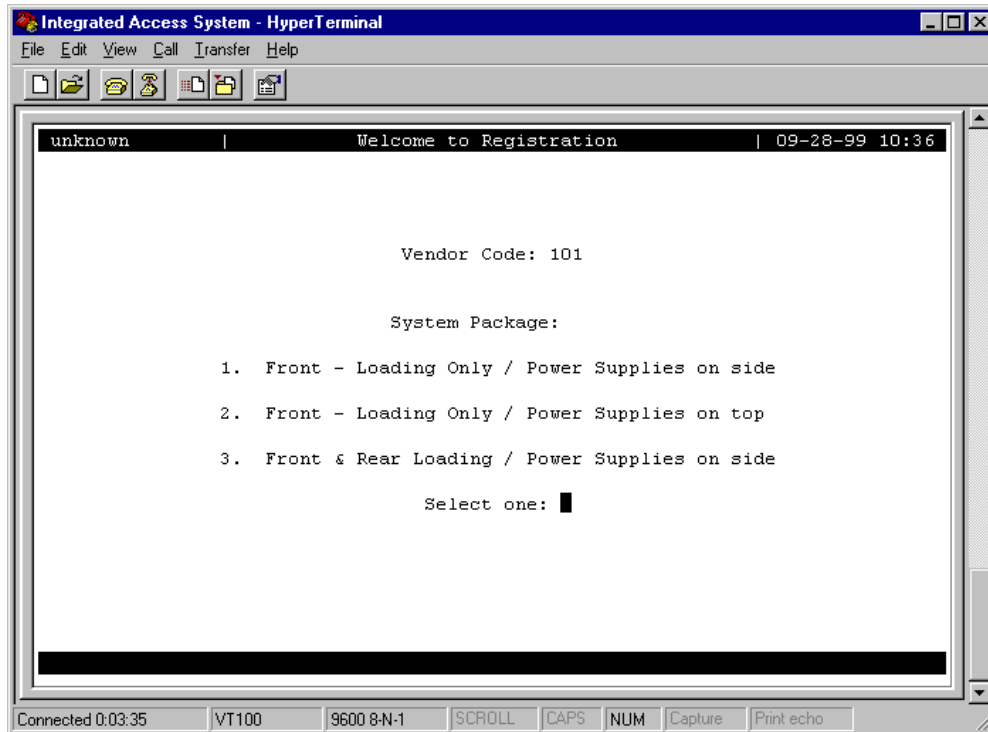

Figure 4-4. Selecting Chassis Type Screen

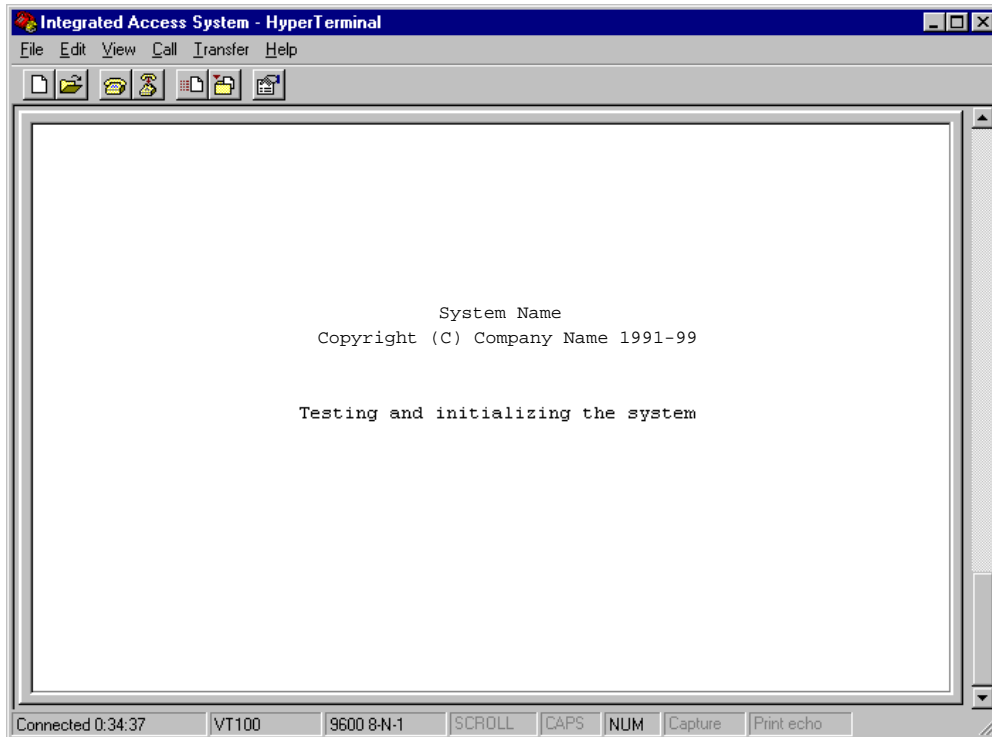

Figure 4-5. Testing and Initialization Screen

The system will display the “Testing and Initializing the System” screen in Figure 4-5 above. When testing and initializing is complete the screen will go blank. Press the <Enter> key. The System Login Screen will display. See Figure 4-6.

4.3.2 Logging Into the System

The first step in starting an operator session is to log into the system. You must enter a password that allows you to perform the required tasks on the system. The initial (default) login passwords correspond to four different access levels, each allowing you to perform certain tasks. Table 4-1 lists the default passwords and describes the access levels.

The “Superuser” password is the highest level of access, followed by “Manager”, “Operator”, and “Viewer” in sequence. Each level allows you to also perform all operations available to the other levels below it. For example, if you log in under the “Operator” password, you can configure the system and perform diagnostic tests, or you can simply view the current system status and configuration data, which are the only tasks permitted under the “Viewer” password.

All passwords are case-sensitive for maximum security. For example, the system handles **TechMan**, **TECHMAN**, and **Techman** as three different passwords.

You can change your Manager, Operator, and Viewer passwords at any time. See your system administrator to change your password or access levels.

Table 4-1. Default Passwords and Access Level

Access Level	Default Password	Description
superuser	*****	Special access for maintenance and diagnostics, to be used under the direction of a qualified technician. Reserved for internal use only.
manager	Manager	Full access to all configuration options, diagnostic tests, and password control.
operator	Operator	Read/write access to configuration and diagnostic features.
viewer	Viewer	Read-only access to configuration and diagnostic features.

To log into the system from a local terminal, proceed as follows. To log in from a remote PC refer to details later in this reference manual.

1. Press <Enter>. The Login Screen depicted in Figure 4-6 should appear. If not, press <Enter> repeatedly until it does.
2. If the Login Screen does not appear after you press <Enter> several times, check your terminal settings (they should be 9.6 kbps, eight data bits, no parity, and one stop bit).

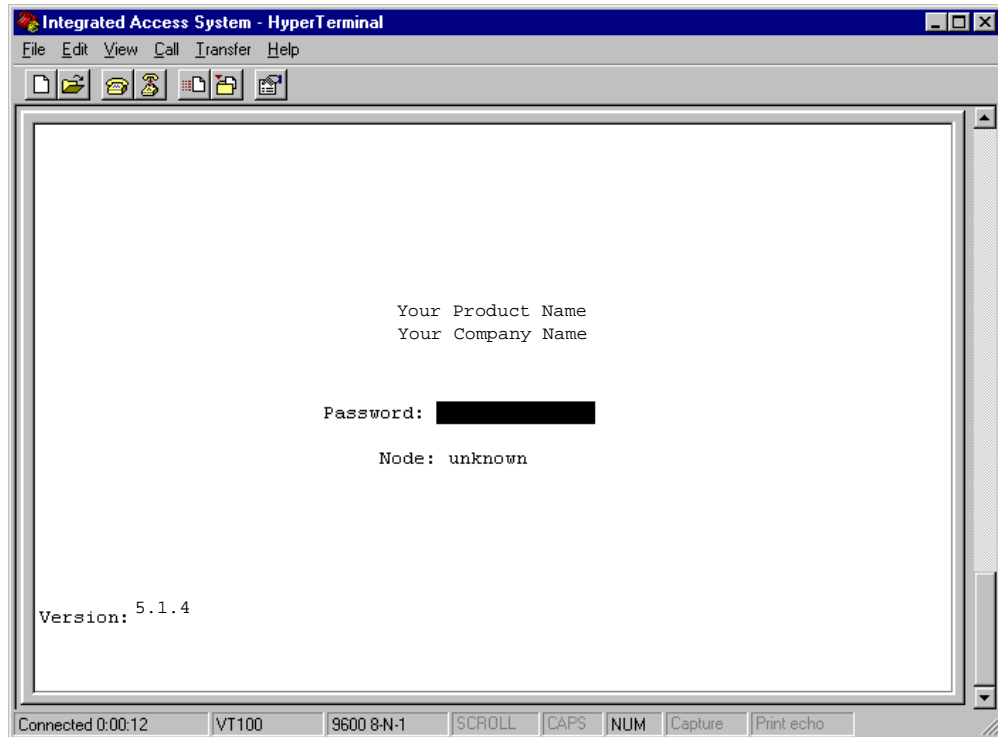

Figure 4-6. Typical Login Screen

3. Contact your system administrator for your Password. Enter your password. Then, press RETURN to accept the password, which will allow you to configure your system after logging in for the very first time. Refer to the next section for descriptions of the various operator password levels.

4. A System Main Screen appears. Figure 4-7 shows this screen for a two-sided chassis and a front-loading chassis with power supplies on top. Figure 4-8 shows a similar screen for a front-loading chassis with power supplies on the side. Refer to the next section for a discussion of the Integrated Access System's user interface screen hierarchy.

This completes the login process. If you are not familiar with the user interface screens of the system, read the next section before proceeding. Otherwise, continue with the desired operation.

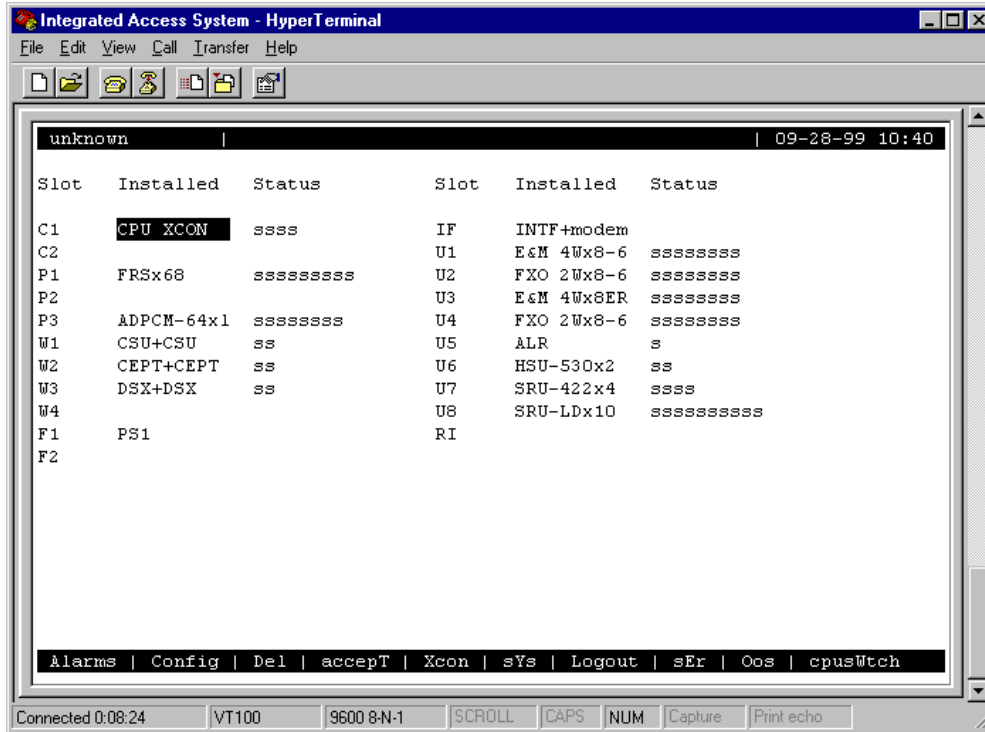

Figure 4-7. Typical System Main Screen (Two-Sided Chassis and Front-Loading Chassis with Power Supplies on Top)

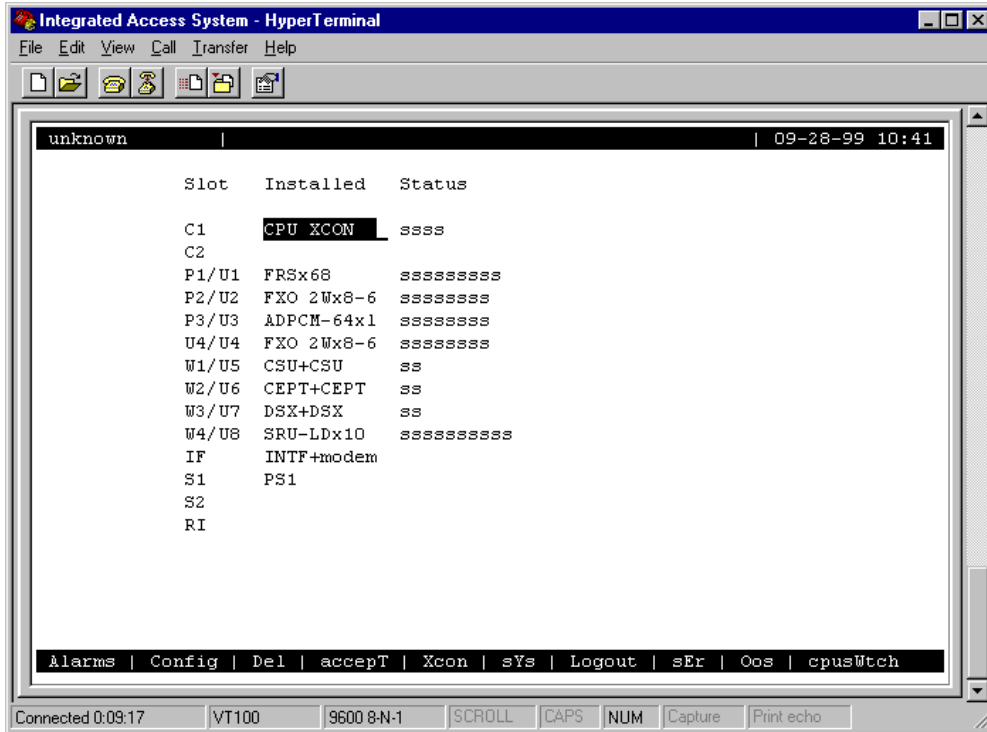

Figure 4-8. Typical System Main Screen (Front-Loading Chassis with Power Supplies on the Side)

4.4 System Screens

The system screen will display each card that is currently installed onto the system along with the card status and location.

4.4.1 System Main Screen

After you log in, a System Main Screen similar to Figure 4-7 or Figure 4-8 appears, showing all of the cards currently in the system. The chassis slot locations, card types, and current card operational states also appear in this screen.

The highlighted line at the bottom of the screen lists some actions. Press the letter key that corresponds to the desired action you want to perform. For example, to go to the Alarms Screen (**Alarms** action) and see the current system alarms, press “a” (**can be typed in either uppercase or lowercase**). Table 4-2 summarizes the System Main Screen actions.

Table 4-2. System Main Screen Actions

Action	Function
--------	----------

Alarms	Brings up the Alarm Screen. Refer to "Alarms and Alarm Filters" later in this chapter.
Config	Sets up the system using a standard configuration.
Del	Removes an out-of-service (OOS) card from system memory.
accepT	Removes the current card settings. Used when replacing a card in any slot with a different kind of card.
Xcon	Brings up the cross-connect screens.
sYs	Brings up the system screen for high-level system testing and maintenance.
Logout	Logs you off the system.
Oos	Allows authorized operators to take cards out of service.
cpusWtch	Switches from the active CPU card to the redundant CPU card, if the system is configured for CPU redundancy.

4.4.2 CPU Card Status

The CPU card status will display **s** (standby) when a CPU card is properly inserted into slot C1 or C2 for all chassis types. The CPU card status will display **a** (active) when router ports C1, C2, C3 or C4 are set to active mode from the nx64 screen. For further explanation on how to set router port parameters, please refer to the nx64 section located in the CPU card chapter in this System Reference Guide.

4.4.3 Power Supplies and Ringing Generators Card Status

The power supply status will display **PS1** when a power supply is properly inserted into slot F1 or F2 for the front-loading chassis with power supplies on top and the front & rear loading chassis with power supplies on side. For the front-loading chassis with power supplies on side, the status will display **PS1** when properly inserted into slot S1. The ringing generator(s) will display **RINGER** next to the slot indicator **RI** on all chassis types.

4.4.4 Voice and Data Card Status

The System Main Screen also displays the status of the individual circuit ports of all WAN, Voice and Data cards in the system. This information appears next to the card type, as shown in Figure 4-9. The lowercase letters in the Status column fields indicate the states of the individual card ports. The possible values for each port are **s** (Standby), **a** (Active), **t** (Test), **l** (currently in a Loopback state), and **r** (on a Redundant WAN or ADPCM card).

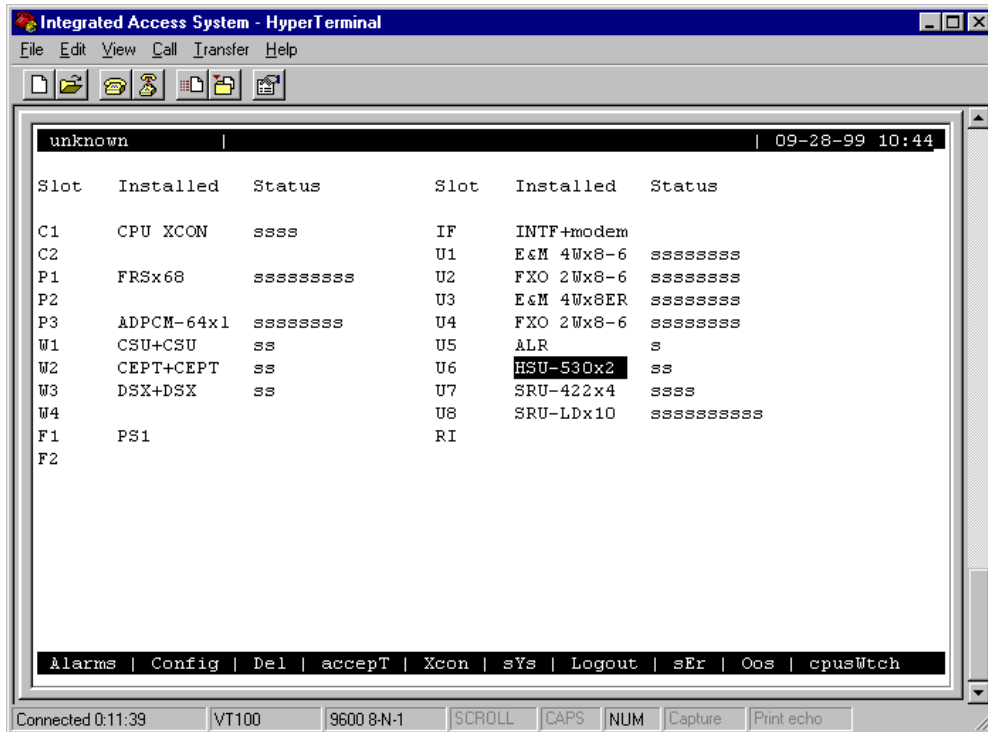

Figure 4-9. Typical Card Status Display

From the System Main Screen, you can also access other screens, as shown in Figure 4-9. These screens are described in the following paragraphs.

4.4.5 Server Card Status

Port status for the ADPCM and ISDN-PRI Server cards is determined in the same way as Voice and Data cards, with the possible status values of **s** (Standby), **a** (Active), and **r** (on a Redundant card).

Port status is determined somewhat differently for the FRS, MCC, and ATM Server cards, since these cards have more logical ports than can be represented on the screen.

4.4.5.1 FRS Card

The FRS Card has a total of 68 logical ports:

- 4 high-speed ports (C1-C4)
- 64 user-scaleable ports

The status for these FRS ports is represented by eight characters. The first four characters represent the status of each C port (C1-C4). The last four characters represent the status of groups of 16 ports (1-16, 17-32, 33-48, and 49-64). If any one of the logical ports in one of these groups is active, the status of that entire group will appear as active (**a**).

4.4.5.2 MCC Card

The MCC card has a total of 132 logical ports:

- 1 Ethernet port (E)
- 3 high-speed ports (C1-C3)
- 128 user-scaleable ports

The status for these MCC ports is represented by ten characters. The first character represents the status of the Ethernet port. The second character represents the status of the combined C ports (C1-C3). The last eight characters represent the status of groups of 16 ports (1-16, 17-32, 33-48, 49-64, 65-80, 81-96, 97-112, and 113-128). If any one of the logical ports in one of these groups is active, the status of that entire group will appear as active (**a**).

4.4.5.3 ATM Card

The ATM card has a total of 165 logical ports:

- 1 UNI port
- 4 high-speed variable bit rate ports (C1-C4)
- 64 user-scaleable variable bit rate ports
- 96 user-scaleable constant bit rate ports

The status for these ATM ports is represented by four characters. The first character represents the status of the UNI port. The second character represents the status of the combined C ports (C1-C3). The third character represents the status of the 64 user-scaleable variable bit rate ports. The fourth character represents the status of the 96 user-scaleable constant bit rate ports. If any one of the logical ports in one of these groups is active, the status of that entire group will appear as active (**a**).

4.4.6 Card Main Screens

Each card in the system has a Card Main Screen associated with it. You can go from the System Main Screen to any Card Main Screen and configure that card. From a Card Main Screen, you can access a Test Screen to perform tests on the card, or (in some cases) a Performance Monitor Screen to view transmission performance data.

Figure 4-10 shows a typical Card Main Screen. The highlighted line at the top of every screen is the header. It lists the node name of the system, the current card type and abbreviated description, the card design revision and serial number, and the current system date and time.

The card configuration parameters and current option settings appear in numerous rows and columns below the header. This region of each screen lists the options on the left and one or more associated columns of data fields from left to right. You can change the settings in those fields as required for each card.

The status and data entry change line appears just above the bottom line of the screen. When you choose a field to edit and press <Enter>, this line shows the currently available option settings for that field. Make all configuration changes on this line.

The highlighted area in the upper right corner shows the current alarm status data. In Figure 4-10, an Out-Of-Service (OOS) alarm has occurred on the card in chassis slot U3.

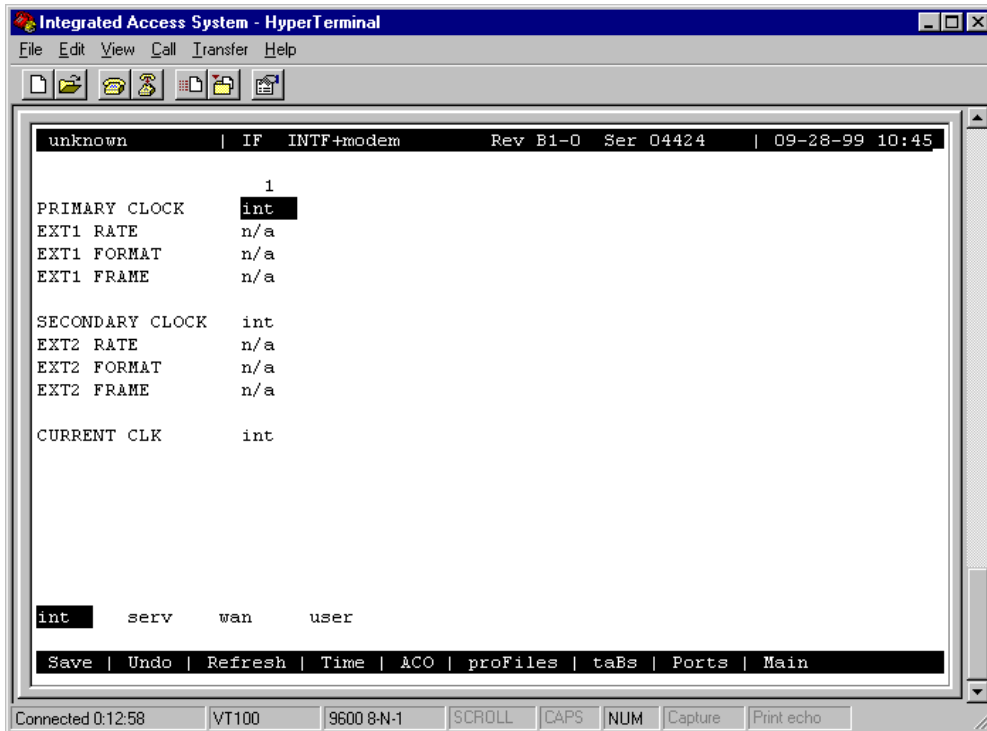

Figure 4-10. Typical Card Main Screen

The bottom line of each Card Main Screen lists other actions you can perform by simply pressing the letter key that corresponds to the uppercase letter of your desired action. In Figure 4-10, for example, if you press “s”, you will invoke the **Save** command, which saves the current option settings in the system’s memory. The actions you can choose from this line depend on which card and screen you are currently accessing. Refer to the associated chapters in this guide for descriptions of those actions.

4.4.7 Test and Debug Screen

You can also go from the System Main Screen to a Test and Debug Screen, which allows you to perform system-level maintenance operations. You can back up the system configuration onto an external computer after saving and subsequently editing it, and (if necessary) you can restore that configuration to the system. You also can erase the system configuration and restart the system with a single “zip” command. Or, you can re-register your system configuration if you change to a different chassis.

The system software also has a built-in debugging utility. However, this utility is only available to factory software engineers. The system maintenance functions are described in the “Testing and Debugging” section later in this chapter.

4.4.8 Time Slot Configuration and Cross-Connect Screens

From the System Main Screen, you also can access a Configuration Screen that lets you automatically configure the system. This time-saving function assigns DS0 time slots of the system’s T1 and E1 WAN lines to certain user voice and data cards in your system. Or, you can access a lower-level screen that lets you cross-connect DS0 time slots between two T1 or E1 lines connected to the system. Refer to these time slot configuration operations later in this manual.

4.5 Card Configuration

4.5.1 Selecting and Configuring Your Cards

The System Main Screen lists all installed cards next to their slot numbers. To access a card from the Main Screen. Move the cursor in the Installed column with the arrow keys until the desired card is highlighted, then press <Enter>. The associated Card Main Screen now appears.

Use the arrow keys to move the cursor around in any card screen. When changing card parameters, some settings require you to enter your own values on the keyboard, while others allow you to select from a list of pre-programmed option settings.

To enter a user-defined value in a field, first highlight that field by moving the cursor to it and press <Enter>. Then, type the desired value on your keyboard and press <Enter> to store it in that field.

To choose an option setting from a list of displayed options, press <Enter> with the associated parameter field highlighted. A series of available option settings now appears for that field. Use the right-arrow and left-arrow keys to move the cursor to the desired setting, and press <Enter> to store that setting in the highlighted field.

Be sure to configure each card according to your networking requirements. From the System Main Screen, select each card in turn and change the options for that card from its Main Screen. Select the **Save** command by pressing “s” after making all the changes for a card, then press “m” to return to the System Main Screen and choose another card. Similarly configure each remaining card in your system.

Once configured, the card settings are permanently stored in Non-Volatile Random Access Memory (NVRAM) on the Interface card. This card is labeled INF on its faceplate ejector. You can then replace faulty cards in your system without having to reconfigure the new cards.

If you replace a card with an identical type new card, the system automatically copies the NVRAM data from its Interface card to the new card. However, if you replace a card with different type of card, you must first delete the existing card settings from the slot before the new card will be recognized by the system. The System Main Screen will display the new card type with a status of “**REJ**” (**Reject**).

If a card (voice or data) in a slot is going to be changed with a different type proceed with the following:

1. Physically remove the card from the slot.
2. From the Main Screen, highlight the card slot and press “D” (**Del**). This deletes all settings from the removed card slot.
3. Place the new card in the slot and ensure that it is properly seated.

4.5.2 Recording Your Configuration Settings

You should always record the configuration option settings for each card after you set them. This information may be needed later for system operation. To record the card configuration data, first photocopy the pages showing the Card Screens in the associated chapters of this guide. Then, mark the option settings you want to use on those pages, and store the pages in a safe place where they can be readily obtained.

You can also record screen settings by “capturing” each edited screen onto your computer terminal while you are logged into the system. To do this, your computer must have a software program capable of capturing the actual screens as text files. The communications software you use to access the system may have this ability. You can then copy the screens to a word processing program, print them out, and store them electronically.

4.6 Reinitializing the System

The system stores information about its currently installed cards, the card configuration option settings, WAN connections, passwords, and other data in nonvolatile memory (NVRAM) on the Interface card. This card is labeled INF-E, INF+M, or INF on its faceplate ejector. Your connection to the system is through the Interface card.

When you remove and replace most card types, the NVRAM remembers the previous card settings. If the same kind of new card is inserted in the slot, you do not need to reprogram the settings. However, if you replace a card with a different type of card, the system lets you delete the old card, so that you can program new parameter settings for the new card (see the **Accept** function described in this chapter).

When you remove and replace an Interface card, the system automatically resets itself. If the new Interface card was not previously used, you must re-register the system. If the new Interface card was previously used, either it will use its internal settings, or the system will request that you “zip” it, causing it to be reprogrammed.

When you remove and replace a CPU card with an **identical** CPU card, the system re-initiates the Interface card’s NVRAM and writes the old parameters (including your current passwords) to the new CPU card. Your CPU card is labeled CPU-5 on its faceplate ejector.



Note: *You must always use a CPU-5 XCON card in your system. CPU cards with any other designations marked on their ejectors will not work.*

If the CPU card is replaced with an identical CPU card but the new card has a different firmware version, a “zip” may need to be performed. The exception is when the firmware change is a maintenance release. (For example upgrading from a 5.1.3 to 5.1.4).

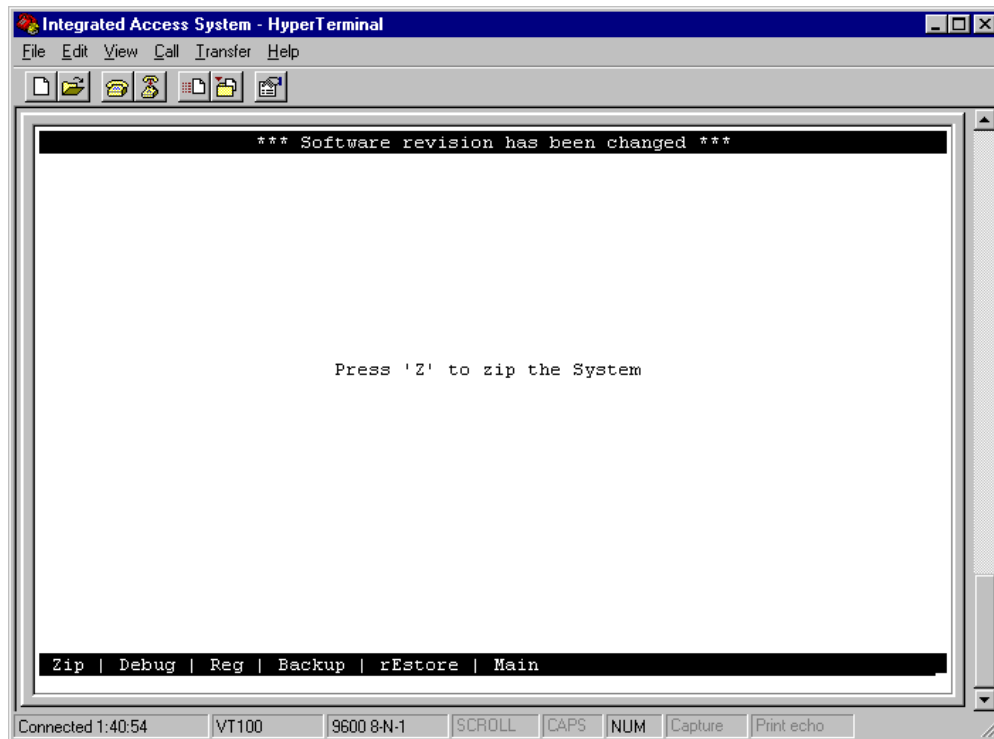

Figure 4-11. Cold-Start NVRAM Test Screen.



WARNING!

The "Z" command will start the ZIP process. "Zipping" the system deletes all of the information stored on NVRAM and resets it. All cards must then be completely reconfigured.

When you press "z", the system will display the main log-in screen and ask for password authorization from either the Manager or Operator access level. After you enter the correct password, the system asks, "OK to Zip the system (y/n)"? Press "y" to have the system test and re initialize itself. All NVRAM information will be erased from the Interface card, and a new log-in screen will appear.

4.7 Alarms

Alarms warn you of problems by reporting possible system hardware or external facility failures. The Alarm screen is accessed from the System Main Screen by pressing the "A" key to go to the Alarm Screen (see Figure 4-12 through Figure 4-14). The Alarm Screen displays the currently active alarms (if any) and provides access to the Alarm Filters and Alarm History screens. Figure 4-12 shows a typical Alarm Screen with an active alarm.

4.7.1 Alarm Screens

Refer to Figure 4-12. To view the current system alarms, you can go from the System Main Screen to an Alarm Screen. From the Alarm Screen, you can then go to an Alarm Filters Screen and set up the alarm reporting filters. Or, you can access an Alarm History Screen (log) and view alarms that were previously logged by the system. These screens and operations are discussed in the "Alarms and Alarm Filters" section later in this chapter.

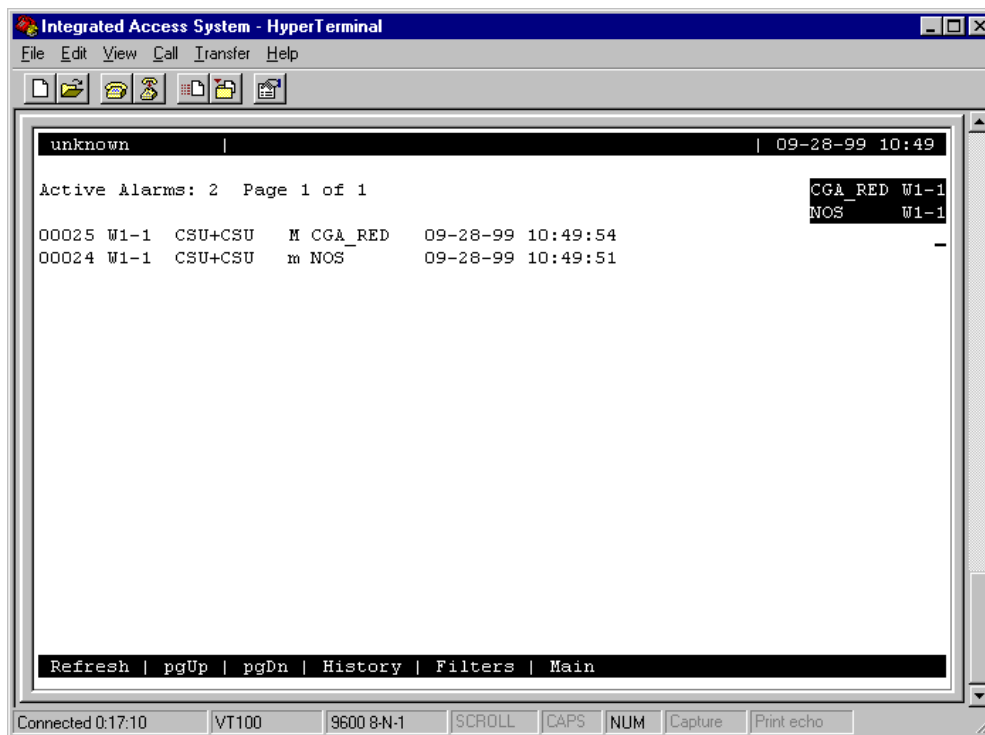

Figure 4-12. Typical Alarm Screen

The first character set (**00025** in the above display) is the Alarm Sequence Number. This is a sequential number from **1** to **65,535**. It identifies the alarm for tracking and maintenance. In the above example, the Alarm Sequence Number is **25**.

The second character set (**w1-1**) is the location of the problem by chassis slot number and port number. In this case, the WAN card in chassis slot W1 is affected, and port 1 of that card has reported the alarm.

The third character set (**CSU + CSU**) is the type of card affected (in this case, a WAN card with two T1 CSU modules).

The fourth character set is the alarm modifier (in this case, **M** indicates a major alarm). See the “Alarms and Alarm Filters” section later in this chapter for more information about alarm modifiers.

The fifth character set (**CGA_RED**) is the type of alarm generated (in this case, a CGA-Red alarm on WAN port W1-1).

The last two character sets are the date and time the alarm was logged.

4.7.2 Alarm Filter Settings

You can set filters for each alarm so that the alarm reports occurrences in a number of different ways. Figure 4-13 shows the Alarm Filters screen, which is accessed by pressing “f” (**F**ilters command) on the Alarm Screen.

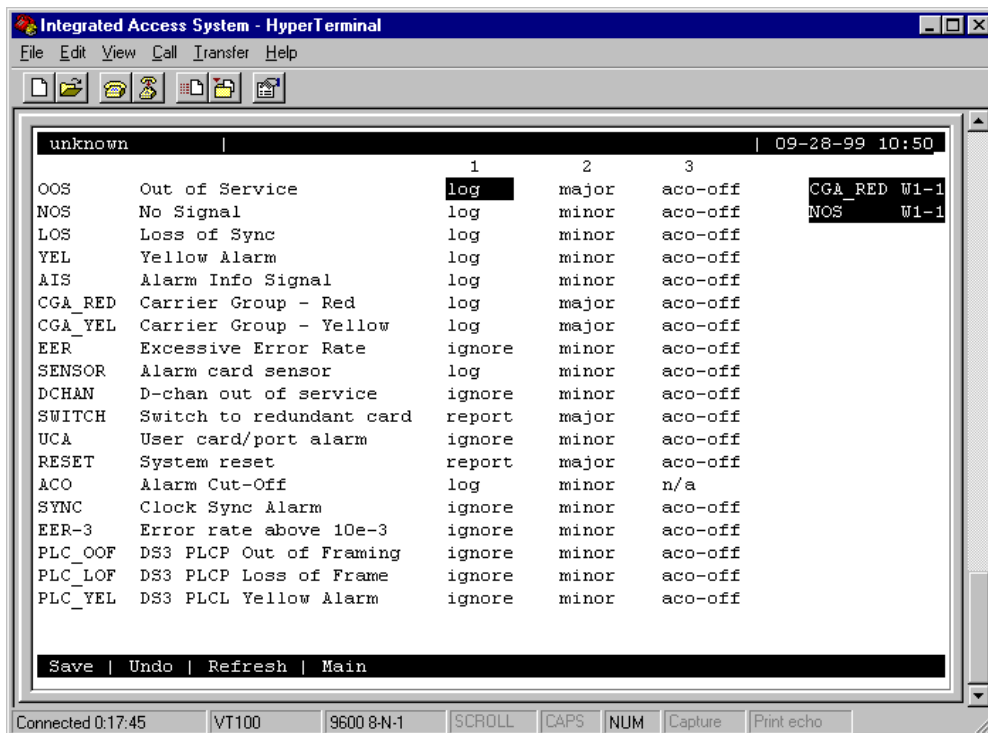

Figure 4-13. Alarm Filters Screen

The first column of the Alarm Filters Screen is the alarm abbreviation that appears when an alarm is generated. The second column is the associated full name of each alarm. Table 4-3 describes each alarm appearing in the Alarm Filters Screen.

The third column contains the filters **ignore**, **log**, and **report**. Set the filter to **ignore** if you want the system to ignore the alarm. Or, set it to **log** if you want the system to show the alarm report on the screen and also log it into the Alarm History, as described later in this chapter.

Set the filter to **report** if you want the system to send (report) the alarm indication to a remote device. With this setting, the system will also display the alarm report on the screen and log it into the Alarm History.

The fourth column of the Alarm Filters Screen contains the filter modifiers **info**, **minor**, **major**, and **crit**. This column specifies a level of importance (information only, minor alarm, major alarm, or critical alarm) for each alarm. These settings are described later in this chapter.

The last column sets the alarm cutoff (ACO) to **aco-off** or **aco-on**. These settings are explained later in this chapter.

The filter in the third column takes precedence over its modifier. If, for instance, you have an alarm filter set to **ignore**, the setting of the modifier as **info**, **minor**, **major**, or **crit** will be ignored. Refer to system specifications section in this manual for alarms and their meanings.

Table 4-3. Alarm Filters

Filter	Alarm	Meaning
OOS	Out of Service	The card, power supply or ringing generator is faulty or has been removed from the unit.
NOS	No Signal	Incoming WAN signal is lost.
LOS	Loss of Synchronization	Frame Alignment is lost.
YEL	Yellow Alarm	The system has received a Yellow Alarm signal from a remote device. Usually received when the device loses WAN signal or synchronization.
AIS	Alarm Information Signal	The system has received a Blue Alarm signal from a remote device. Usually received when the remote or intermediate device has a major failure.
CGA_RED	Carrier Group Alarm - Red	The local incoming WAN signal has a serious problem and trunk conditioning is started. After receiving a RED alarm (NOS or LOS) for 2-3 seconds, the system initiates the appropriate trunk conditioning sequence (see voice cards for information about the TC_CGA setting) and sends a Yellow Alarm to the remote device. If the system is in drop/insert mode, it also sends an AIS signal to the downstream equipment.
CGA_YEL	Carrier Group Alarm - Yellow	The system has initiated trunk conditioning in response to a Yellow Alarm from a remote device. After 2-3 seconds, the system initiates the appropriate trunk conditioning sequence (see voice cards for information about the TC_CGA setting).
ERR	Excessive Error Rate	The error rate measured by the system has exceeded the threshold set on the WAN card.
SENSOR	Alarm Card Sensor	The Alarm Card sensor has received an alarm indication from an attached device.

DCHAN	D-chan out of service	If the network side D channel loses contact with the user side, an alarm message will be generated. The alarm message will show the slot # and D channel # where the problem exists.
SWITCH	Switch to redundant card	The primary card has failed and the system has switched to the redundant card.
UCA	User card/port alarm	One or more active ports on a user card are not working properly. Voice ports will show an alarm for excessive signaling transitions and data ports will show an alarm for exceeding the data error threshold.
RESET	System reset	The system has been reset by either loss of power or by a system software upgrade.
ACO	Alarm Cut-Off	The ACO option forces you to manually clear certain alarms. Without this option, self-correcting alarms might not be noticed. When the ACO option is set to either Report or Log and the modifier is set to Major, alarms will report normally but will also generate an ACO alarm. If the modifier is set to Minor, it will not generate the ACO alarm. If the filter is set to Ignore, no alarms will be generated. This can depend on whether or not CPU is set for latch or CUR .
SYNC	Clock Sync Alarm	The SYNC alarm is generated when either the primary or secondary external clock source is lost. This alarm is in addition to the condition that lost the clock source (CGA-RED or OOS).
ERR-3	Excessive Error Rate (10e-3)	While using transcoder operations for E1 that involve downstream tributaries, setting EER-3 to “report” will cause an alarm to appear on the local system when E1 transmission errors exceed 10e-3 (1 in 1000). The local EER-3 alarm will identify the effected WAN link (i.e., W1-1) and take it out of service. Simultaneously, the downstream tributary will receive an AIS alarm to warn them of the condition.
PLC_OOF	DS3 PLCP Out of Framing	Physical Layer Convergence Protocol is Out of Framing.
PLC_LOF	DS3 PLCP Loss of Frame	Physical Layer Convergence Protocol has Lost Framing.
PLC_YEL	DS3 PLCL Yellow Alarm	Physical Layer Convergence Protocol is reporting a Yellow Alarm.
BP_OOS	Backplane Out of Service	Indicates an internal corruption of a message that may be caused by a variety of external or internal events. (See further description of BP_OOS below.)

4.7.3 Alarm Modifiers

Each alarm may also be designated as **I=info**, **m=minor**, **M=major** or **C=crit**. The filter modifier appears on both the active alarm and alarm history screens.

If the system has an External Alarm card (optional), the occurrence of any alarm designated as **crit** will trigger a form-C relay contact on the External Alarm card. The relay contact action sets off an annunciator or lamp at the equipment site. Similarly, the occurrence of any alarm designated as **major** triggers a different contact and activates another external indicator. Refer to the Alarm Card Reference Guide for more information on the External Alarm cards.

4.7.4 Alarm Cutoff (ACO)

The ACO (Alarm Cutoff) security feature is used by the system to alert an operator to alarms that clear themselves while the system is unattended. The ACO option settings are **aco-on** and **aco-off**. If ACO is set to report or log alarms, any alarm set to report or log with a major modifier brings up an additional alarm message on the screen. You must manually clear this message, which is the ACO alarm message (depends on whether or not CPU is set for latch or CUR). The ACO is used with the node port of the Interface card. It can also trigger an external alarm device, such as a bell or lamp, that must also be manually cleared.

All ACO alarms must be cleared from the Interface card screen. ACO alarms can be cleared automatically or manually.

4.7.5 Backplane Out of Service (BP_OOS)

The host CPU polls each card periodically for a variety of information and alarm status. The card responds with a multi-field message to the host with such information as alarm condition (either active or not and type of alarm), slot number, etc. Alarms are automatically set or cleared based on the contents of these messages returned by each card. For the BP-OOS alarm, the slot number reported from a card is corrupted for an OOS type alarm. The CPU reports BP-OOS when it indexes outside the boundaries of a defined alarm.

Possible causes for this alarm type include:

1. Improper grounding of the system. Floating lines on the backplane can cause the message between card and host to be corrupted, so proper grounding can have a positive effect on removing this condition.
2. Improper seating of cards may cause an intermittent error where the CPU receives incorrect data from the card.
3. Defective serial memory on a card or defective NVRAM on the Interface card can also cause this condition to occur in the field.
4. In earlier software releases, if an operator erroneously attempted an OOS operation on an empty slot, a BP-OOS alarm would be generated. Protection for this condition was added in recent software releases to prevent this alarm from being reported under this condition.

Once activated, this alarm can only be cleared as follows.

- a) For cause type 4 above, contact technical support to clear the alarm that does not require step b) to be performed.
- b) For all conditions other than type 4 above, the system must be zipped (resetting all the possible alarm codes off).

4.7.6 Alarm Handling

The **report** alarm function attempts to send alarm information to a remote printer, network management system (NMS), or other device, in addition to recording the alarm in the Alarm History log. These features use the built-in serial port and modem on the Interface card. You also need to change the settings in the Printout Alarms Screen or TCP/IP Screen of the Interface card to activate the alarm reporting functions.

Alarms set to either **log** or **report** record occurrences automatically to the Alarm History Screen. To view that screen, press **“h”** (**H**istory command) in the Alarm Screen. Figure 4-14 shows a typical Alarm History Screen, in which you can update the log with any new alarms that occur. To do this, press **“r”** to select **Refresh** in the Alarm History Screen. Or, to delete all entries in the log, press **“c”** to select **Clear** in the Alarm History Screen.

The alarm log may contain more than one screen (page) of data. To scroll through the log, press **“u”** or **“d”** (**pgUp** or **pgDn**) to move up one page or down one page at a time. The latest alarms appear at the beginning of the log, which is on the first page of the alarm log.

All alarms (except those set to **ignore**) appear in the Alarms field in the upper right corner of the screen, regardless of their setting in the Alarm Filters screen. The display in the Alarms field is an abbreviated version of the alarm name and slot number. For example, **“OOS U3”** indicates that the card in user slot U3 is out of service.

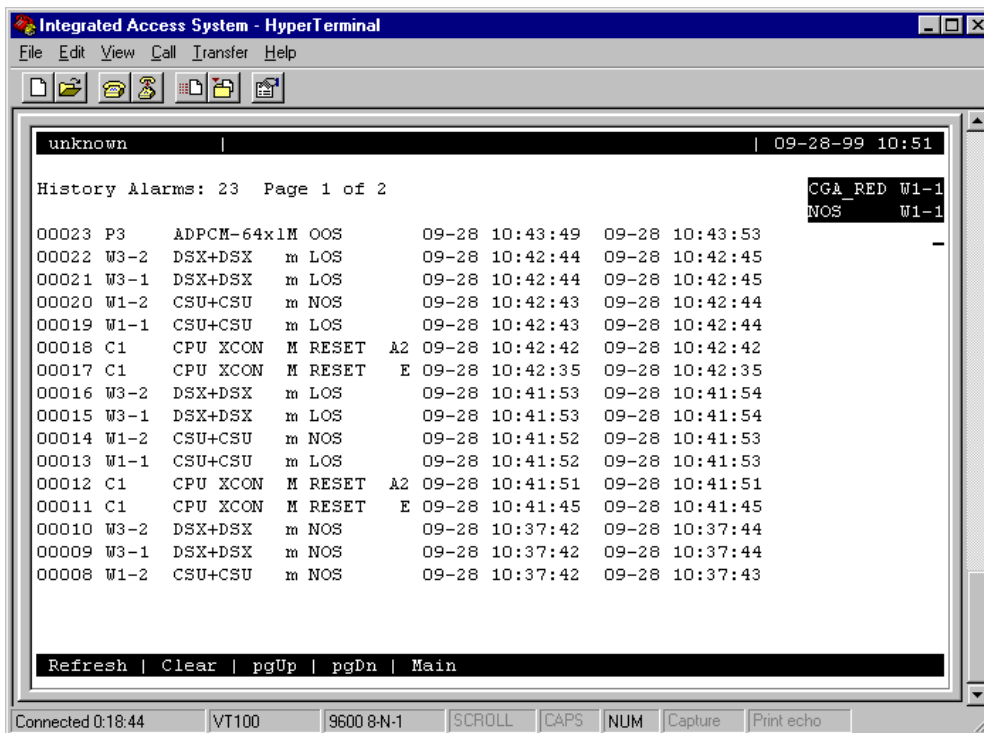

Figure 4-14. Typical Alarm History Screen

4.8 Time Slot Configuration Screen

From the System Main Screen, you can access a Configuration Screen by pressing “**c**” (**Config**) that lets you automatically configure the system. This time-saving function assigns DS0 time slots of the system’s T1 and E1 WAN lines to certain user voice and data cards in your system. Or, you can access a lower-level screen that lets you cross-connect DS0 time slots between two T1 or E1 lines connected to the system. Refer to these time slot configuration operations later in this manual.

4.9 Deleting an Out of Service Card

When a user card is out of service the screen will display an OOS in the status field next to the associated card installed. If you still want to remove this card press “**d**” (**Del**) to delete this card from the System Main Screen. The system will display a message, “OK to lose card settings (y/n)?”, press “**y**” and the system will remove that card from the System Main Screen.

4.10 Accepting New Card Settings

When a user card is replaced with a different type of card the system will remove the current card settings. The system will show “**REJ**” on the System Main Screen. Press “**t**” (**acceptT**) in the System Main Screen to accept the new settings.

4.11 Cross-Connecting (XCON)

From the System Main Screen, you can access a Cross-Connect Screen by pressing “**x**” (**Xcon**) that lets you cross-connect WAN time slots between T1 and E1 links. Refer to the Cross-Connecting WAN Time Slots section later in this manual.

4.12 System Level Maintenance

You can also go from the System Main Screen to a Test and Debug Screen, by pressing “**y**” (**sYs**) which allows you to perform system-level maintenance operations. You can back up the system configuration onto an external computer after saving and subsequently editing it, and (if necessary) you can restore that configuration to the system (*refer to the backup and restore section later in this chapter*). You also can erase the system configuration and restart the system with a single “zip” command. Or, you can re-register your system configuration if you change to a different chassis.

The system software also has a built-in debugging utility. However, this utility is only available to factory software engineers. The system maintenance functions are described in the “Testing and Debugging” section later in this chapter.

4.12.1 Test, Debug, Backup & Restore

Advanced configuration and diagnostics are available through the use of the **sYs (sYstem)** command from the System Main Screen. Pressing “y” brings up the Test and Debug screen shown in Figure 4-15.

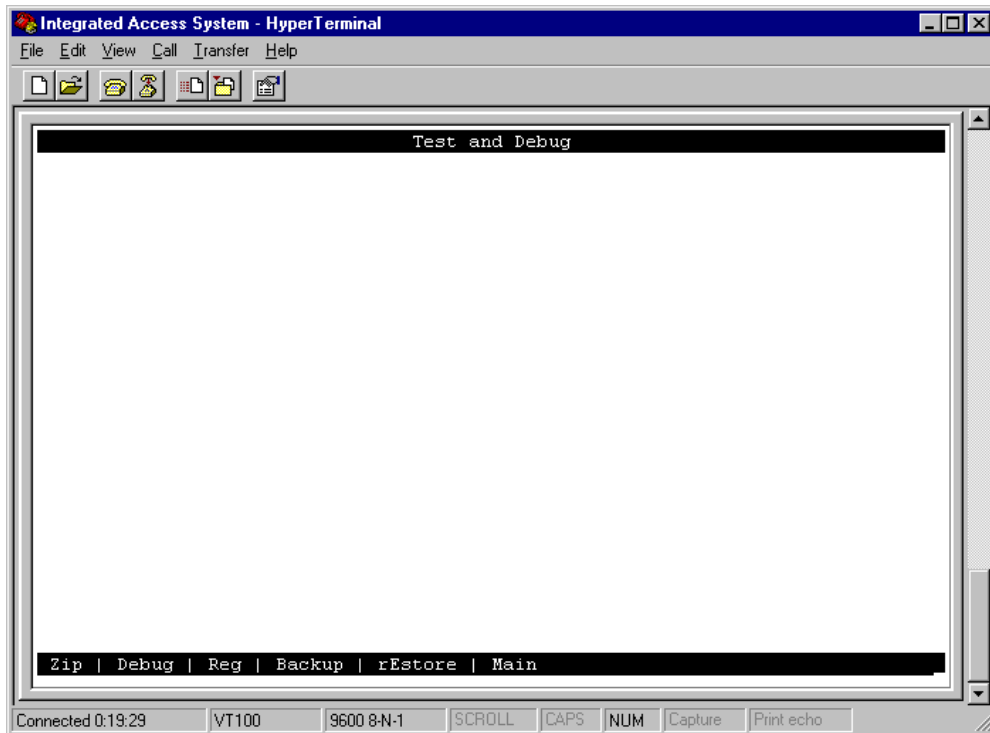

Figure 4-15. System Test and Debug Screen

4.12.2 Zipping the System

Figure 4-16 shows a typical Zip Screen, which appears when you press “z” in the Test and Debug Screen.



CAUTION!

The "Z" (Zip) command allows a user logged in under the Operator or higher password level to reprogram the entire system. Because the options for all cards in the system will revert back to their original factory settings, be sure to carefully consider the consequences of "zipping" your system before doing so.

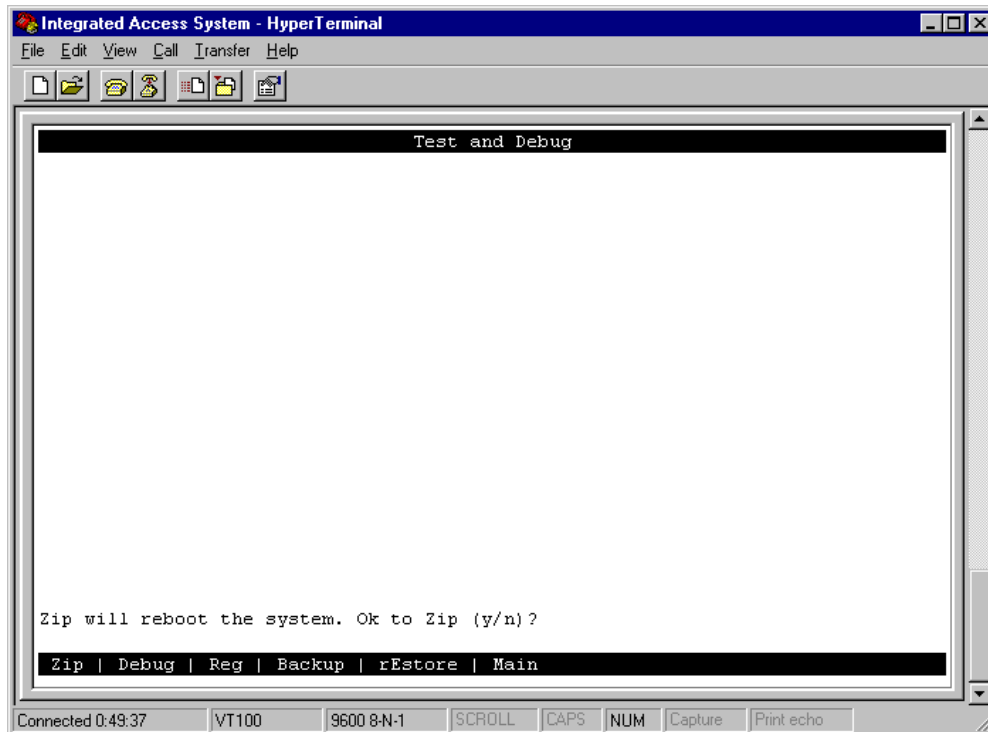

Figure 4-16. Zip Screen

4.12.3 Debugging the System

The **D** (Debug) command is only available to factory personnel with a password authorization higher than "Superuser." It gives access to the system software coding.

4.12.4 Registering the System

The **R** (Registration) command allows a user with Operator or higher password authority to change the system registration. The original registration is explained earlier in this chapter. You must have this information to properly re-register the system. **Do not use this command during normal system operation.**

The registration procedure consists of three steps. First, you must enter the vendor code. Then, you must select the type of chassis used. Finally, confirmation of the proposed changes is required (**Y** = yes, **N** = no).

4.12.5 Pre-TFTP Backup and Restore Preparation

To perform backup and restore uploads/downloads via the TFTP function, one of the following two methods of connection to a Local Area Network (LAN) network must first be selected.

1. The first option requires that the system to which you will download be powered and running through an active MCC server card that is connected to a LAN. The connection must be made either in the box that will receive the downloaded or in a remote box routed through the local CPU that is set as a gateway using IP protocol. You must be able to ping the MCC card and the local and remote CPU host IP addresses from the PC or server that you intend to use as a TFTP server and vice versa. The DEF RTE on the MCC Ethernet configuration screen must be set to *static* and must include the IP address of the PC or server from which you are downloading the firmware. You may need to change the routing table on your PC to include the MCC ethernet address as the gateway, or the local host address as the gateway for the system receiving the file as the destination IP address.
2. The second option is to connect to the Integrated Access System interface card's COM (C1) port to which you will download the firmware using PPP or SLIP protocol at 19.2k or 9.6k respectively. Again, you may need to change the routing table on your PC and/or on the router or terminal server through which the PPP/SLIP connection runs.



Note: *Your PC must have some sort of TFTP or TFTP server software installed and running when you are downloading the binary files to the system. If you are using TFTP type software it is easier if you set the root directory to indicate where the binary file is located at the TFTP root screen. This eliminates the need to enter a path at the file name screen during the download process. If you are running a TFTP software package, consult the user guide accompanying the software for details on configuring and using the software.*

4.12.6 TFTP Backup for 5.x.x

Follow the instructions listed below to perform a TFTP backup.

1. Log into the Integrated Access System using the Manager Password.
2. Press “**Y**” for **System** at the main menu.
3. At the Test and Debug screen press “**B**” for **Backup**.
4. The NV Ram Backup screen will appear. Using the arrow keys to navigate the cursor, highlight the *Protocol* selection and press **Enter**.

5. Select **Flash** using the arrow keys and press **Enter** (NV Ram must be backed up to Flash before proceeding with tftp or xmodem backups).
6. Press **“G” for Go** - an NV image overwrite command confirmation appears (i.e., *Previous NV image, cksum: 0x2DF05, date 09-8-96 05:58 overwrite (y/n)?*). Enter **“Y”** for yes.
7. Confirmation appears when the NV Ram flash backup is complete. Press **Enter** as prompted on the screen.
8. TFTP backup is now ready to proceed. Select TFTP by highlighting the appropriate protocol using the arrow keys. Press **Enter** when *TFTP* is highlighted.
9. Press **“G” for Go**.
10. A series of four questions must be answered to complete the backup process. The questions are as follows:

The system asks for the desired number of mismatch retries. Enter an appropriate number between 1-40, with 20 as default. Press **Enter**.

The system asks for the desired number of Timeout Retries. Enter an appropriate number between 1-10, with 4 as default. Press **Enter**.

Next, the system requires the IP address of the PC or TFTP server to which the backup will be sent. Following entry of the IP address press the **Return** key to continue.

Finally, the system requires entry of the filename for the backup being performed. Following entry of a filename the backup process begins. A *TFTP backup complete* message appears when the process finishes.

Finally, the system requires entry of the filename for the backup being performed. Following entry of a filename the backup process begins. A *TFTP backup complete* message appears when the process finishes.

4.12.7 TFTP Restore for 5.x.x

Follow the instructions listed below to perform a TFTP restore.

1. At the main menu press **“Y”** for **System**.
2. Press **“E”** for **Restore** at the Test and Debug menu.
3. Use the arrow keys to highlight the Protocol selection and press **Enter**.
4. Select **TFTP** and press **Enter**.
5. You will receive an NV Ram image overwrite confirmation message. Press **“Y”** for **yes**.

6. Enter the desired number of Mismatch retries and press **Enter**.
7. Enter the desired number of Timeout Retries and press **Enter**.
8. Enter the IP address of the PC or TFTP server and press **Enter**.
9. Enter the filename for the backup you wish to restore and press **Enter**. Restoration begins.
10. Following completion of the restoration process, the system will prompt to restore data with the image that was uploaded. Press **“Y”** for **yes**.
11. The system asks to reboot. Press **“Y”** for **yes**. The system reboots and configuration becomes active.

4.12.8 ASCII Backup Procedure

Following the steps listed below to perform an ASCII backup.

1. Log into the Integrated Access System.
2. Press **“Y”** for **System** at the main menu.
3. At the Test and Debug screen press **“B”** for **Backup**.
4. The NV Ram Backup screen appears. Using the arrow keys to navigate the cursor, highlight the *Protocol* selection and press **Enter**.
5. Using the arrow keys highlight **‘ascii’** (ASCII is the normal default selection) and press **Enter**.
6. Prior to starting the backup and restore process you must set the terminal emulation package to XMODEM1K or XMODEM, otherwise the process will fail.
7. From the Terminal Emulation window select **Capture Text File**. The system will prompt for the desired filename and path to store the backup file. Following entry of this information press **Enter**. The filename must include **.txt** as an extension or the backup will not function properly.
8. From the NV Ram Backup screen press **“G”** for **Go**. The Integrated Access System begins transferring the configuration to a text file. Upon completion, the system prompts you to enter **“m”**. You must first select **Capture Text** from the Terminal Emulation Menu and select **Stop**. You may then proceed with pressing **“m”**.

4.12.9 ASCII Restore Procedure

Following the steps listed below to perform an ASCII restore.

1. From the main menu press “**Y**” for **System**.
2. Press “**E**” for **Restore**.
3. Select “**ascii**” from the *Protocol* selection using the arrow keys to navigate. Press **Enter**.
4. Press “**G**” for **Go**.
5. From the Terminal Emulation Screen Menu select **Send Text File**. The system prompts for the filename and path. Following entry of appropriate information, the restore process begins. If a *process completed* message appears immediately following the start of the process, an error has occurred. If this happens, check to ensure that the file being sent to the system includes a **.TXT** extension.
6. Upon completion of restoration, the system prompts you to **press ESC twice**. The system then reboots itself.
7. Following reboot, press “**Y**” for **Yes** when prompted. The system configuration information should be restored.

4.12.10 XMODEM 128k and XMODEM 1k Backup

Follow the steps listed below to perform an XMODEM 128k or XMODEM 1k backup. (Note that XMODEM 128k is slower than XMODEM 1k.)

1. Log into the Integrated Access System on which the backup is to be performed.
2. Press “**Y**” for **System** at the main menu.
3. When the Test and Debug screen appears, press “**B**” for **Backup**.
4. The NV Ram Backup screen next appears. Using the arrow keys to navigate the cursor, highlight the *Protocol* selection and press **Enter**.
5. Select **Flash** using the arrow keys and press **Enter** (NV Ram must be backed up to Flash before proceeding with TFTP or XMODEM backups).
6. Press “**G**” for **Go**. An NV Ram image overwrite command confirmation appears (i.e., *Previous NV image, cksum: ox2DF05, date 09-08-96 05:58 overwrite (y/n)?*) Enter “**Y**” for **yes**.
7. A confirmation appears upon completion of the NV Ram backup to flash. Press **Enter** as prompted on the screen.
8. Prior to starting the backup or restore process, ensure that have the PC emulation package is set to the XMODEM or XMODEM1K type format, otherwise an error will occur during the process. XMODEM backup is now ready to proceed.

9. Select XMODEM 128k or XMODEM 1k by highlighting *Protocol* using the arrow keys. Press **Enter** when the XMODEM protocol to be used is highlighted.
10. To begin backup, press “**G**” for **Go** and press **Enter**.
11. From the terminal screen select “**Receive File**” from the appropriate file menu. The system prompts for a backup storage directory and filename. Following entry of the appropriate information, backup begins. With most terminal emulation software (i.e., Hyperterminal, ProCom, or Smartcom) a status window will appear during the backup process.
12. A system backup completion message appears and the system then prompts you to press **Enter** to continue. The backup is now complete.

4.12.11 XMODEM 128k and XMODEM 1k Restore

Follow the steps listed below to perform an XMODEM 128k or XMODEM 1k restore. (Note that XMODEM 128k is slower than XMODEM 1k.)

1. Log into the Integrated Access System to be restored.
2. To restore a previous backup access the main menu. Press “**Y**” for **System**.
3. Press “**E**” for **Restore** at the Test and Debug screen.
4. At the NV Ram Restore menu select *Protocol* and press **Enter**.
5. Select the proper XMODEM transfer method and press **Enter**.
6. Press “**G**” for **Go** to begin restore. The system will prompt whether or not to overwrite the current NV Ram image. Select “**Y**” for **Yes** and press **Enter**.
7. From the terminal emulation window select “**Send File**”. Enter the correct location and filename of the backup to be restored and press **Enter**. Restoration should begin and a progress monitor screen will appear.
8. Upon completion of the restoration, the system prompts whether or not to restore the NV Ram image, select “**Y**” for **Yes**.
9. The system prompts whether or not to reboot. Select “**Y**” for **Yes**.
10. Following system reboot, login as usual and proceed as appropriate.

4.13 Taking a Card Out of Service

The user can “OOS” (**Out Of Service**) a card for various reasons by pressing “O” (**OOS**) from the System Main Screen. Some reasons that the card is in OOS state may be that the card isn’t working properly, the system needs a warm boot or troubleshooting a card. A card that is working properly cannot be set to Out of Service (OOS) without first removing the card.

4.14 CPU Switching

This host release provides CPU redundancy switching by pressing “W” (**cpusWtch**) from the System Main Screen. The CPU redundancy switching is from a CPU in slot C1 to a redundant CPU in slot C2. When this process takes place the CPU in slot C2 is now active and the CPU in slot C1 is redundant. Refer to the CPU Card Redundancy section later in this manual.

4.15 Time Slot Assignment

This section provides instructions for assigning DS0 time slots to the voice and data cards of the Integrated Access System. It also provides time slot cross-connection and broadcast setup instructions.

The Integrated Access System maximizes the use of incoming and outgoing T1 and/or E1 lines. You can do this by assigning specific channels, or *DS0 time slots*, to voice and data cards in the system. You also can cross-connect time slots between T1 and/or E1 WAN ports of the system.

The CPU Card allows you to connect one DS0 time slot to another. Throughout this chapter, these connections are called "pass-through" circuits because they link a time slot from one T1 or E1 line to another through the system. You can therefore have up to eight separate T1 or E1 links on four WAN cards, in any cross-connect combination.

The following sections of this chapter describe several ways for you to administer your networks and correctly allocate transmission bandwidth to meet your needs. The next section deals with assigning time slots to the user voice and data card. The second section describes a time-saving tool known as the *Configuration* option, which automatically assigns sequential WAN time slots to the ports of user voice cards.

The third section deals with cross-connecting WAN time slots to other WAN time slots. The fourth section addresses a special application that supports the ability to broadcast a data signal over multiple WAN aggregates.

The fifth section describes signaling status, signaling, and companding conversion. The last section shows you how to view the time slot map after making your assignments and cross-connections.

This chapter defines "assigning time slots" as the process of connecting user card ports to WAN ports and time slots, and it defines "cross-connecting time slots" as the process of connecting WAN time slots to other WAN time slots in the system.

4.15.1 Modes of Operation

In the 5.x system, the only mode available is *XCON*.

4.15.1.1 XCON Mode (XCON)

The XCON mode allows the user to cross-connect DS0s to user voice or data cards or to cross-connect any DS0 on any WAN card to any DS0 on any other WAN card in the system. The "Mode" setting on a WAN in a XCON system will only indicate the XCON option.

4.16 Assigning Time Slots

You must use a *time slot map* to specify the connections between all incoming and outgoing lines connected to the system. The time slot map lets you split up your T1 and E1 bandwidths into portions required for normal voice and data communications. It contains the connections for all cards in your system.

4.16.1 Assigning a Time Slot to a User Card Port

You can define a time slot map from any user card (data or voice) for connections involving that card, or from a WAN card for cross-connections involving only WAN cards. For example, Figure 4-17 shows the E&M Card Main Screen for the time slot assignments. Assign time slots to a voice card as follows:

1. From the System Main Screen, select the desired voice card and press <Enter>. That card's Main Screen appears.
2. Select the WAN port from which you want to assign time slots to the E&M card. In Figure 4-17, this is **W1-1** (for WAN 1, port 1).
3. Select a time slot (TS) for the first card port. A number appears at the bottom of the screen for the corresponding time slot on the WAN port.
4. Set the time slot number by using the up and down arrow keys to highlight it, then press the <Enter> key.
5. Change the STATE of the port from **stdby** to **actv**.
6. Repeat steps 2 through 5 for the remaining card ports, to assign time slots to them.

7. Press “s” to save your settings, using the **Save** command in the Card Main Screen.

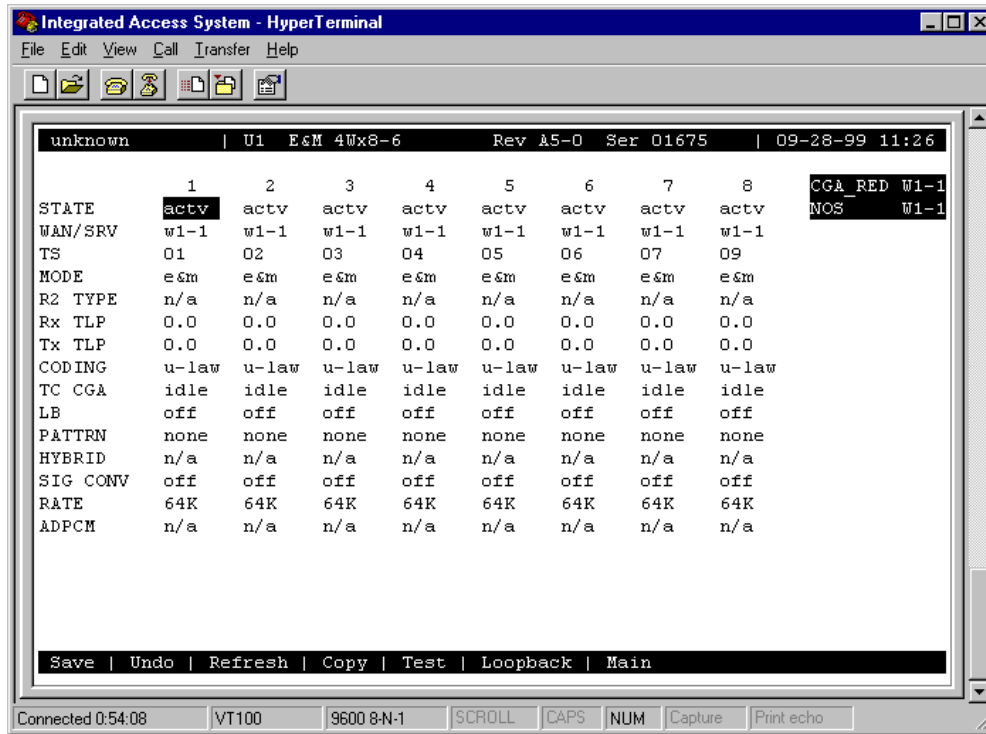

Figure 4-17. Typical E&M Card Time Slot Assignments

4.16.2 Assigning Multiple Time Slots to a Port

Figure 4-18 shows the HSU Card Main Screen for the time slot assignment example. Assign time slots to this card as follows:

1. From the Main Screen, select the desired HSU card and press <Enter>.
2. Select the WAN port to which you want to assign the HSU port. In Figure 4-18, this port is **W1-1** (for WAN 1, port 1).
3. Select the TS table. All time slots of the selected WAN port appear at the bottom of the screen. These are 1 to 24 for a T1 port, or 1 to 31 for an E1 port.
4. Place an “x” under each desired time slot, using the space bar to either select or de-select a time slot. Use the right arrow key to move to the next time slot (TS) for selection. Then, press <Enter>. In Figure 4-18 (for T1), the HSU port is assigned eight time slots (9 to 16). In Figure 4-19 (for E1), the HSU port is assigned eight time slots (17 to 24).

5. Change the STATE of the port from **stdby** to **actv**.
6. Press “s” to save your settings.



Note: In E1, time slots 0 and 16 are reserved.

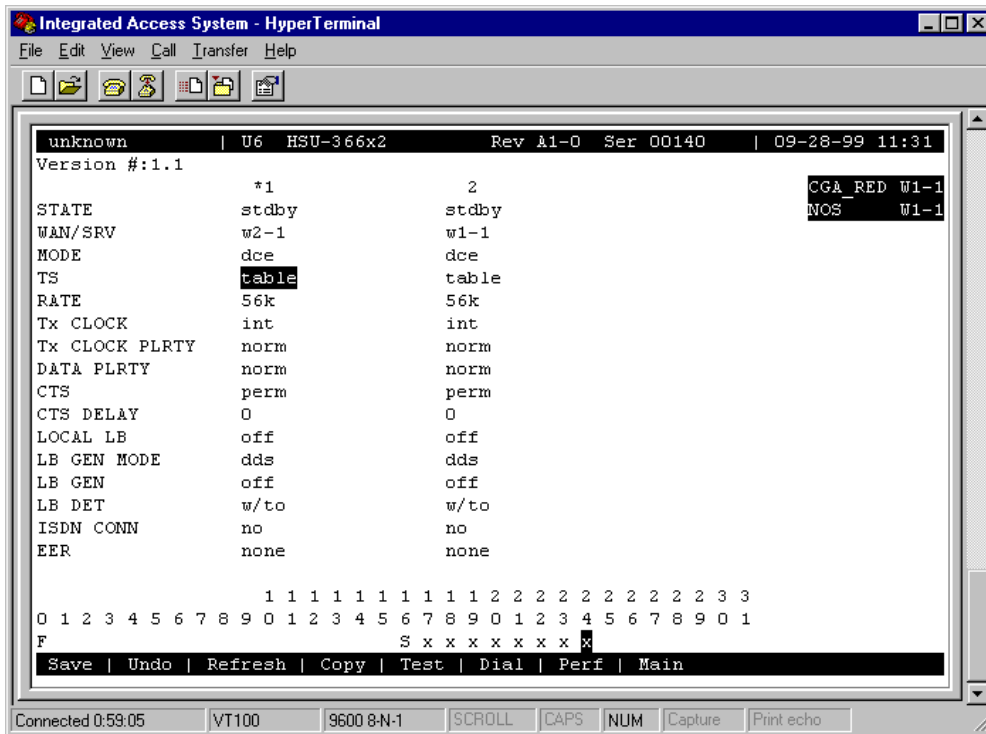

Figure 4-18. Typical HSU Card Time Slot Assignments for T1

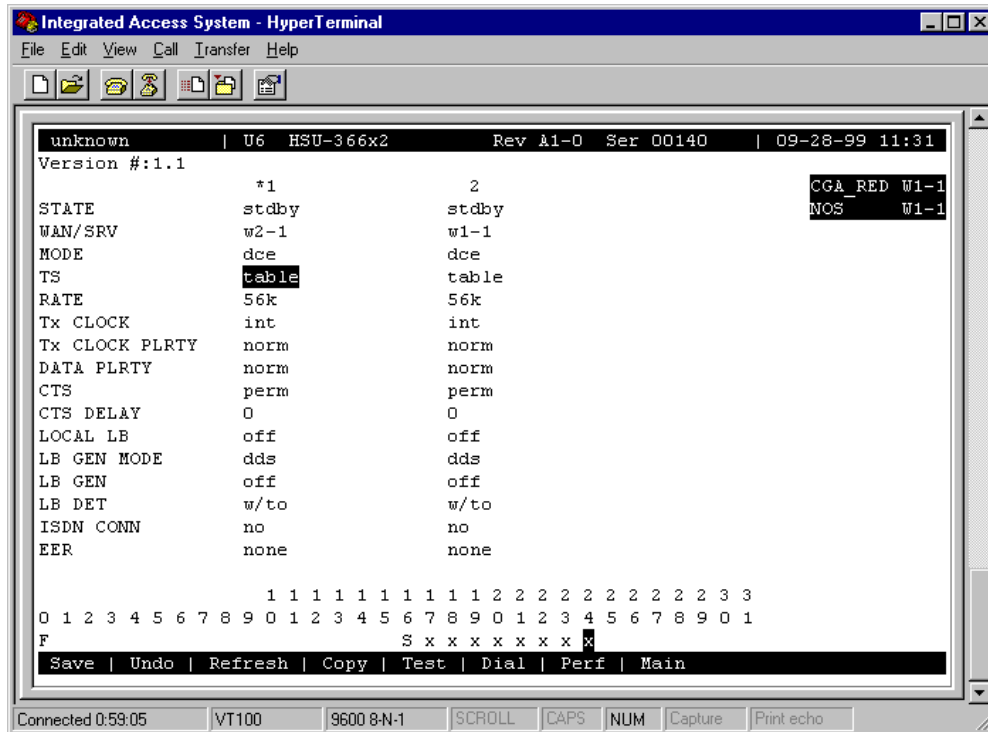

Figure 4-19. Typical HSU Card Time Slot Assignments for E1

4.16.3 Cross-Connect Model

The Cross-connect model allows you to access two T1/E1 links for each of four WAN cards, for a total of eight T1/E1 links. All WAN card connections to other WAN cards are accomplished through the cross-connect option on the System Main Screen, and must be individually specified. User cards on systems equipped with a CPU XCON card are assigned to WAN time slots.

4.17 Automatic Time Slot Assignment

You can automatically assign time slots to voice (E&M, FXS, etc.) cards by using the Configuration command in the System Main Screen. Figure 4-20 shows typical time slot assignments from four E&M cards to an E1 WAN port. The Configuration option automatically assigns the eight ports of E&M card 1 to time slots 1 through 8, seven ports of E&M card 2 to time slots 9 through 15, and all eight ports of E&M card 3 to time slots 17 through 24. Time Slots 25 through 31 are similarly assigned to E&M card 4, ports 1 through 7. Time Slot 16 is not assigned to any E&M card ports because it is reserved for channel-associated signaling (CAS) or common channel signaling (CCS) transmission on an E1 line.

For a T1 WAN port, the configuration command would assign time slots 1 through 8 to the eight ports of the first E&M card. Time Slots 9 through 16 would similarly go to the eight ports of a second E&M card, and time slots 17 through 24 would go to a third E&M card.

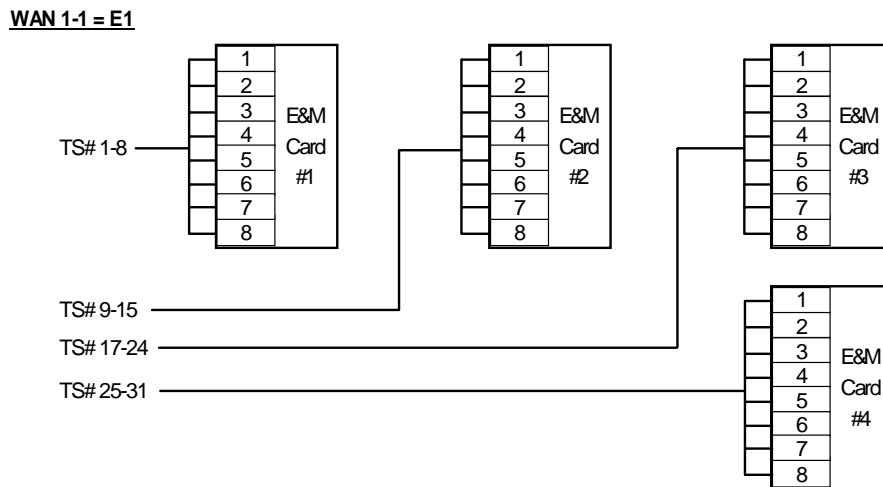

Figure 4-20. Automatic Time Slot Assignment Example

To use the Configuration command, first proceed as follows:

1. Make sure all voice cards you intend to configure are of the same type.
2. Place the cursor on the first user card slot that will have a card. In Figure 4-21, slots U5 through U8 will be assigned to 30 time slots on the E1 WAN port.
3. Press “**c**” to begin the configuration process.
4. Select the type of voice card from the types listed above the bottom line of the screen, as shown in Figure 4-21. In that screen, **e&m-6** is chosen as the card type (E&M, 600 ohms).

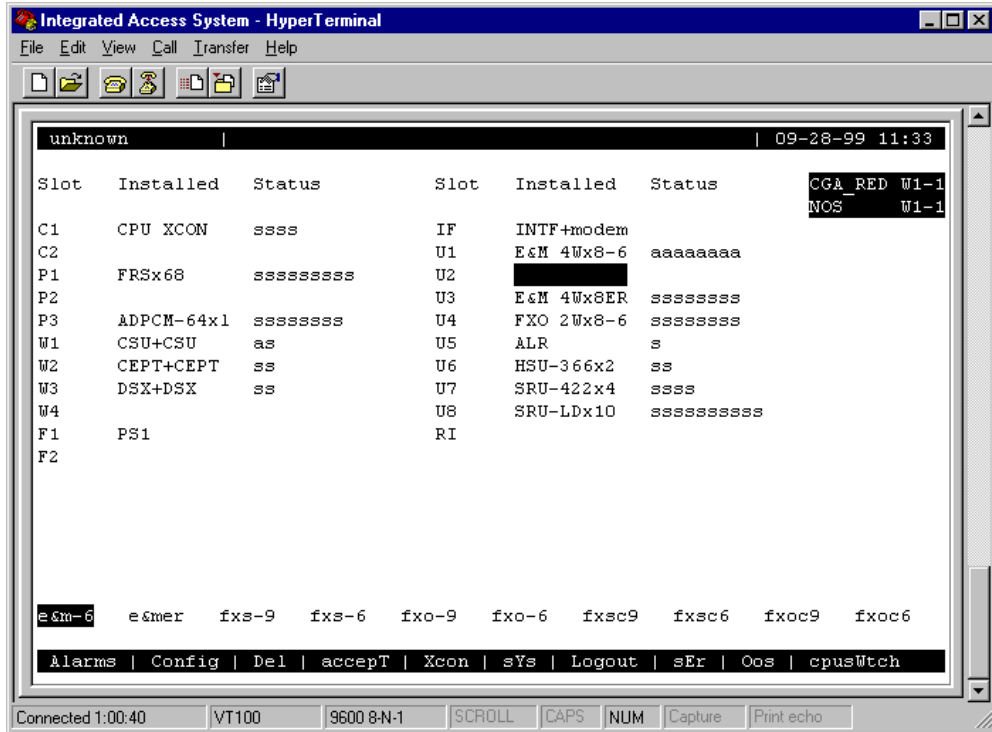

Figure 4-21. Typical Card Slot and Type Selection

5. Select the WAN port to which you want to assign the voice cards (W1-1 or W1-2), as shown in Figure 4-22.

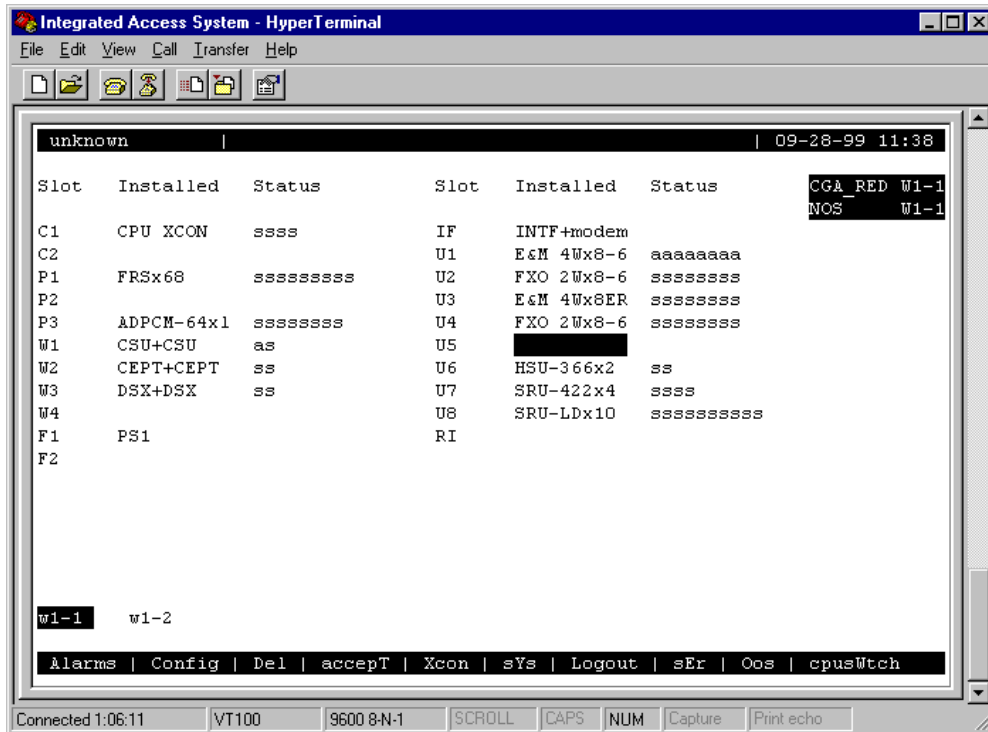

Figure 4-22. Typical WAN Card Selection

- The system automatically builds the necessary time slot structure. Since the user slots are vacant, the system will register Out Of Service (OOS) alarms for each of the four cards, as shown in Figure 4-23.

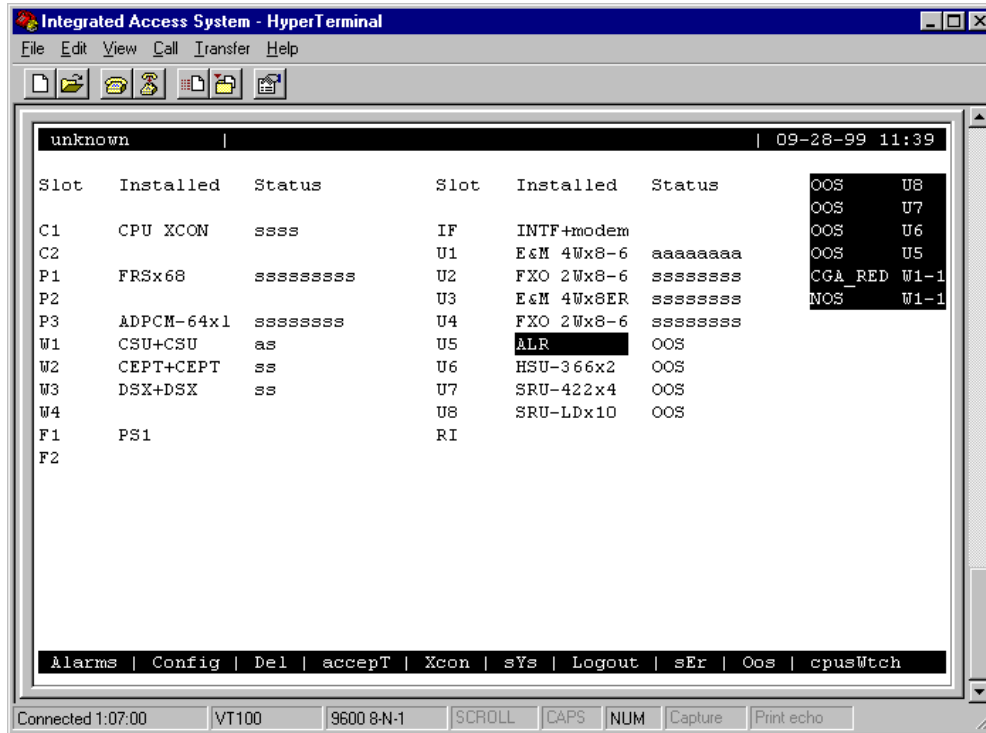

Figure 4-23. Typical System Main Screen with Alarms

7. Insert the four voice cards into the chassis, to clear the OOS alarms.

Figure 4-24 shows the WAN Cross-Connect Screen with the correctly assigned time slots.

In Figure 4-24, the XCON column shows the user card slot and card port to which each time slot of the E1 line is assigned. Time Slot 16 is reserved for signaling (CAS), and time slot 0 is used for signal frame alignment.

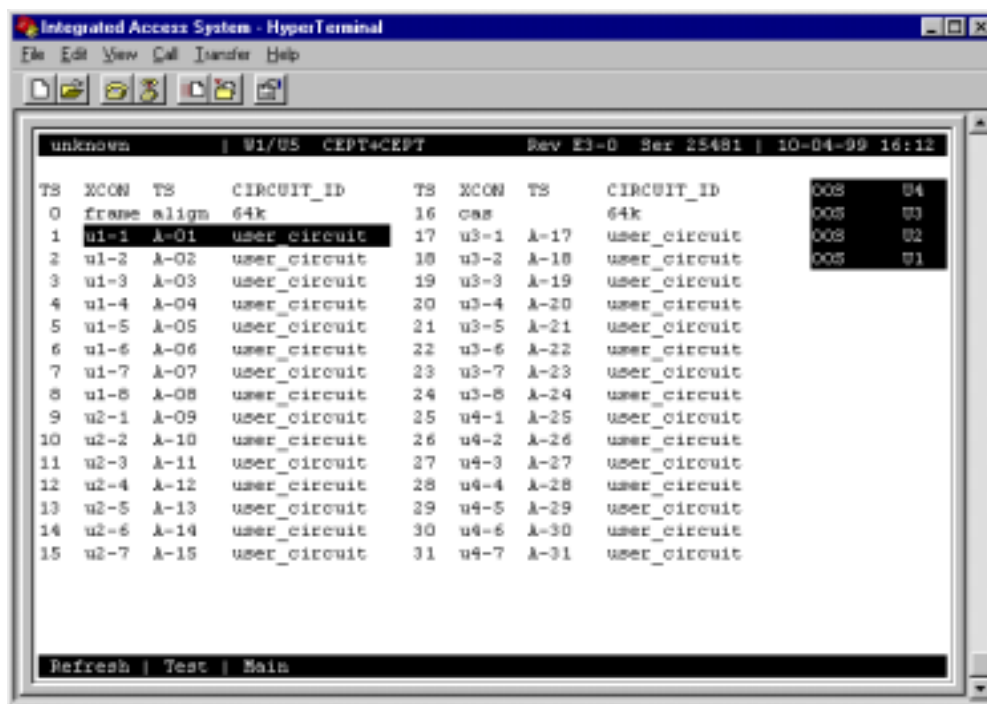

Figure 4-24. Typical WAN Time Slot Assignment Screen

4.18 Cross-Connecting WAN Time Slots

After assigning the user cards to DS0 time slots, you can also assign the remaining WAN time slots for pass-through cross-connections between T1 and E1 links.

You can cross-connect WAN time slots from the System Main Screen. To perform cross-connections, press “x” in that screen to invoke the **Xcon** command. The CPU Cross-Connect Screen in Figure 4-25 appears. In the cross-connect screen, type “a” to add a cross-connect circuit. The **Add** command provides the fields used to program all of the "pass-through" circuits in the network (See Figure 4-26). Table 4-4 lists the circuit parameters and their options and default settings.

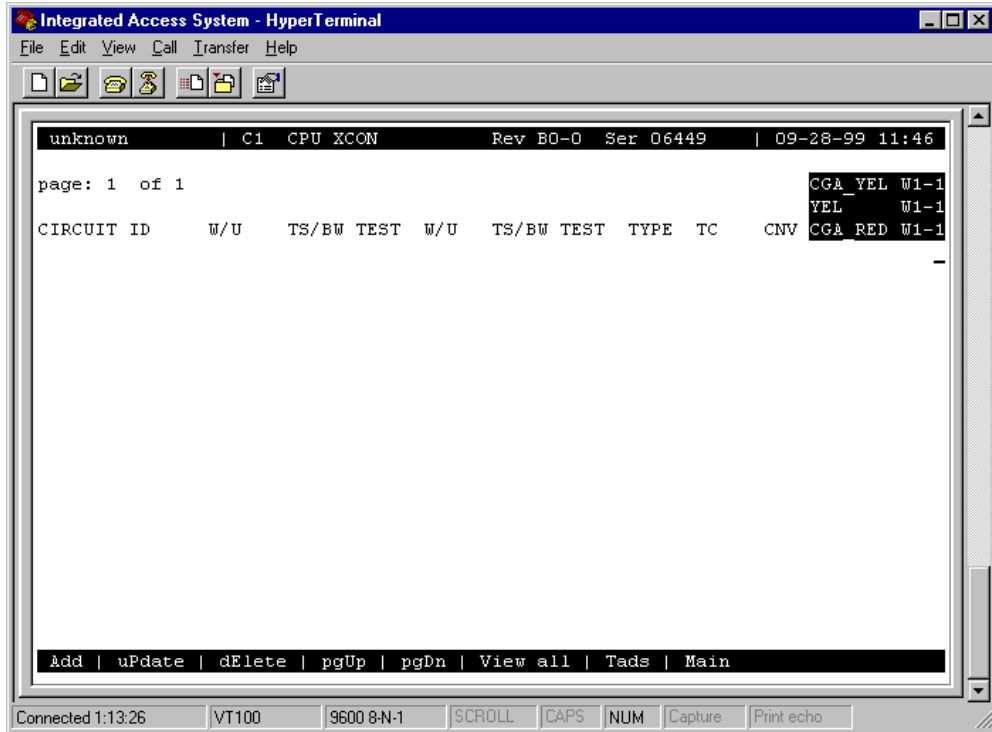

Figure 4-25. Typical CPU Cross-Connect Screen

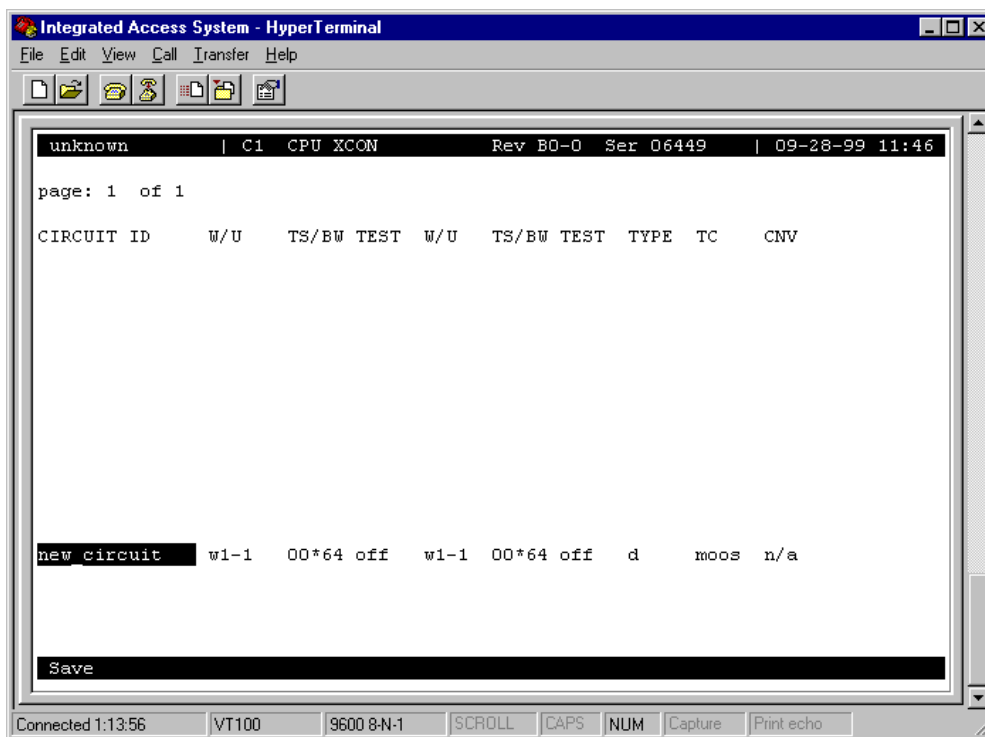

Figure 4-26. Add a Cross-Connect Circuit Screen

Table 4-4. Time Slot Cross-Connection Options and Defaults

Parameter	User Options	Default
CIRCUIT ID	Any combination of letters or numbers up to 14 characters, including spaces	*****
W/U	w1-1 w1-2 w2-1 w2-2 w3-1 w3-2 w4-1 w4-2	w1-1
TS/BW	table	00
TEST	off all0 all 1 m_oos 1:1 1:7 lpbk 300Hz 1KHz 3KHz	off
W/U	w1-1 w1-2 w2-1 w2-2 w3-1 w3-2 w4-1 w4-2	w1-1
TS/BW	table	00
TEST	off all0 all 1 m_oos 1:1 1:7 lpbk 300Hz 1KHz 3KHz	off
TYPE	v v&s d	d
TC		
v	n/a	no
v&s	e&m fxsl fxsg fxsd plar dpo fxol fxog fxod dpt user*(this selection will require a user-defined bit pattern) mrd	e&m
d	n/a	n/a
CNV		
PCM CONV	none A-mu mu-A	none

SIG CONV	none ABCD-AB01	ANSI-CCITT CCITT-ANSI	ABCD-ABAB	none
-------------	-------------------	--------------------------	-----------	------

CIRCUIT ID

A *circuit* is defined as a group of one or more DS0 time slots cross-connected from one WAN link to another. Each circuit can carry either voice or data traffic, and needs its own name to facilitate cross-connect management within the system. The Circuit ID field allows you to name individual pass-through circuits. The factory-default ID is "new circuit." However, you can change the ID to show any relevant title for the pass-through connection, although each circuit ID must be unique. This ID can contain up to 14 numbers, letters (uppercase and lowercase), and spaces, in any combination. Figure 4-27 shows an example of a new circuit, which is named **SF01-NY01**.



WARNING!

When cross-connecting multiple independent data DS0 time slots (sequentially grouped time slots should work) for data. Super-rate [data type cross-connect] is multiple DS0s sequentially assigned between WAN aggregates in a cross-connect system. **DO NOT** attempt to save time by cross-connecting independent data time slots as one super-rate circuit (could cause data errors.) This limitation does not apply to voice time slots.

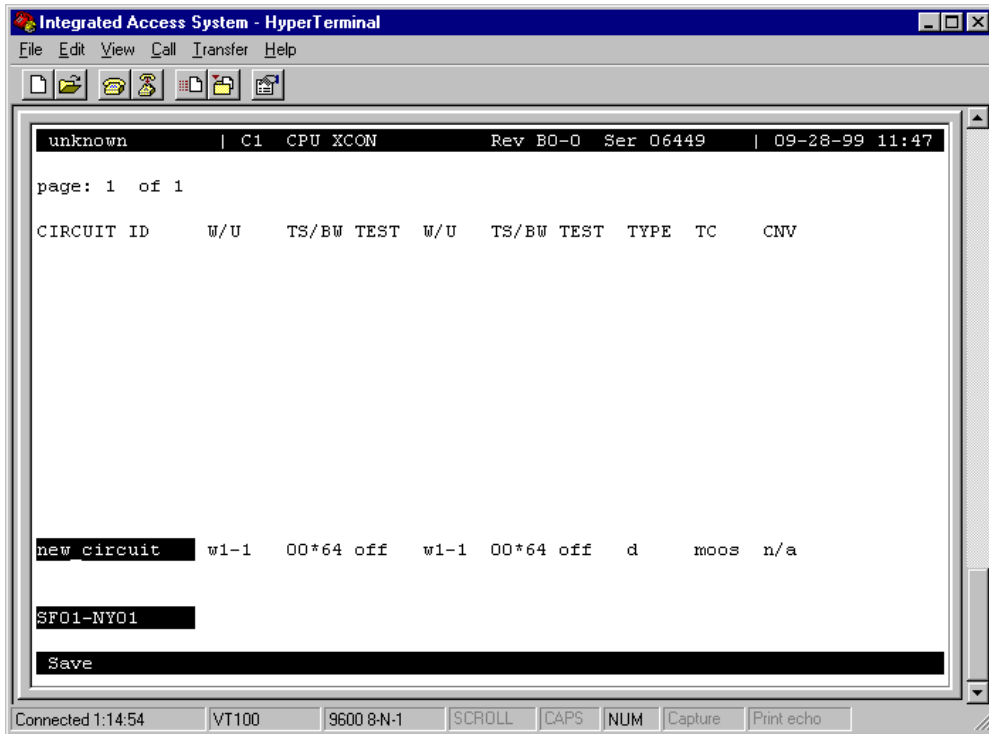

Figure 4-27. New Circuit Selection and ID Assignment

W/U

The first WAN Unit (W/U) column is the T1/E1 link in which the pass-through connection begins (since these circuits are bi-directional, the concept of beginning or ending is used for illustrative purposes only). The options are all WAN cards and ports, and the identification uses the same convention (**w1-1, w1-2, etc.**) seen earlier. If a WAN card is not present in the W/U selected, an error message is generated.

The example in Figure 4-28 shows **w1-1** (WAN 1, port 1) as the selected WAN card and port.

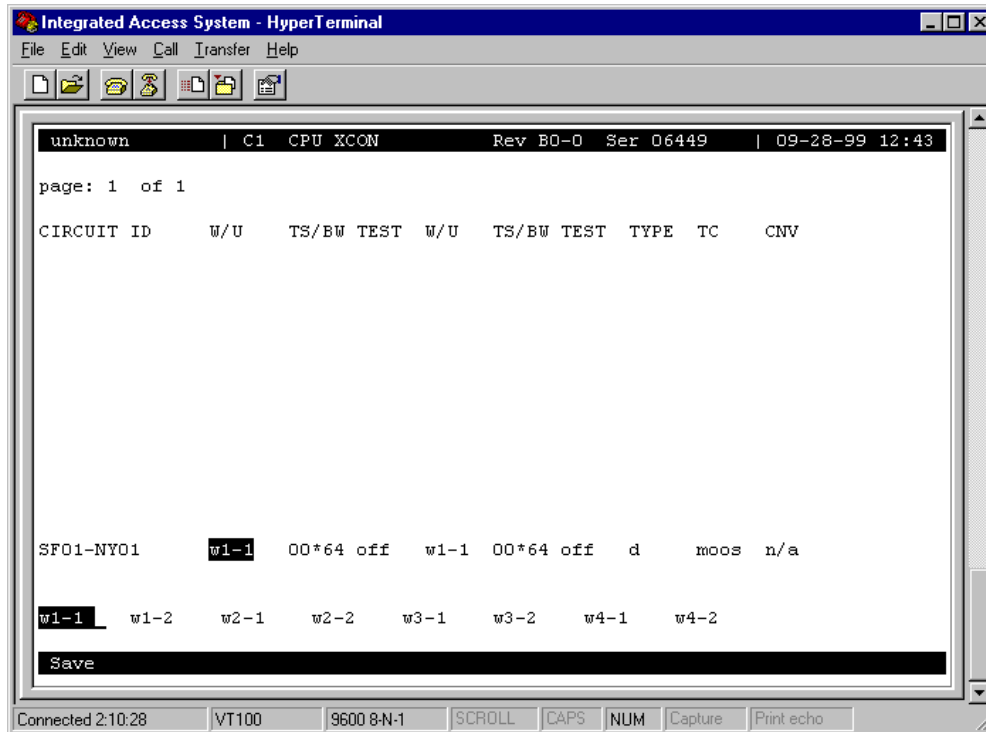

Figure 4-28. WAN Unit Options

TS/BW

The first Time Slot/Bandwidth column shows the different time slots of **w1-1** that will be assigned to this pass-through connection. Figure 4-29 shows the selection of time slots 8 to time slot 12 of **w1-1** assigned to the start of the connection. Any number of time slots from **1** to **24** is allowed for T1 transmission. Or, time slots **1** to **15** and **17** to **31** are allowed for E1 operations. *The bandwidth is automatically assigned.*

Make your selection by using the space bar and arrow keys. The arrow key moves from slot to slot, and the space bar toggles between selecting and deselecting a time slot.

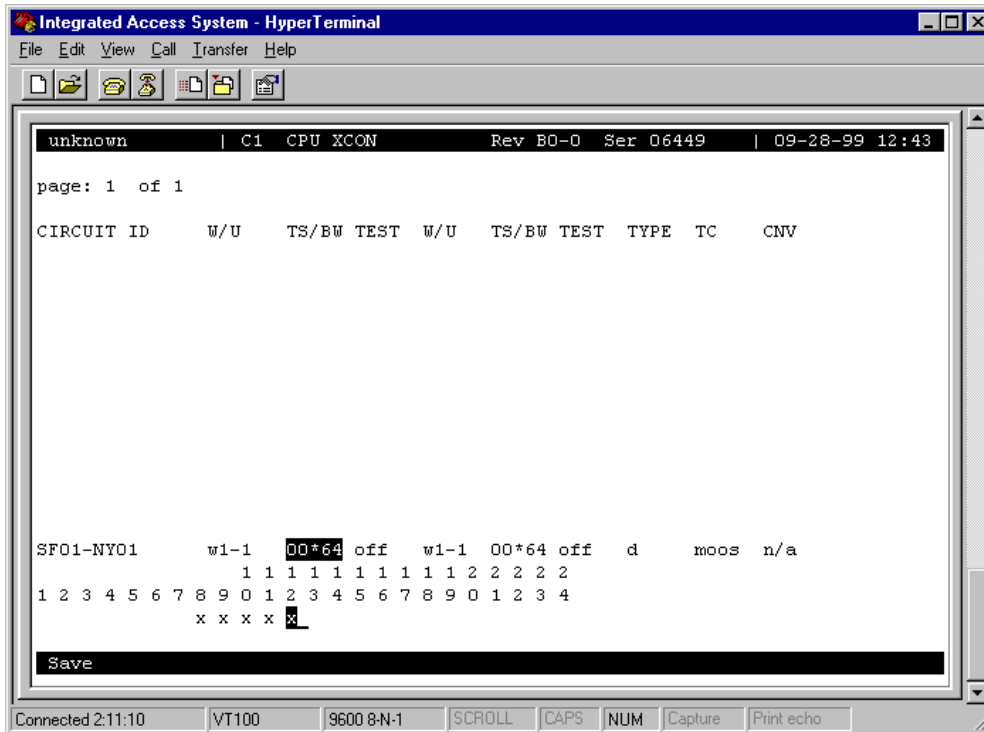

Figure 4-29. Time Slot and Bandwidth Options

TEST

The first Test column allows you to select the test pattern to be applied to this circuit in the direction of the first WAN link specified. Figure 4-29 shows the options, which you can select by highlighting the choice and pressing <Enter>. The choices are **off** (no testing); **all 0** (all zeros); **all 1** (all ones); **m_oos** (Multiplexer Out Of Sync); **1:1** ("one-to-one" pattern, where a 1 is followed by a zero); **1:7** ("one-to-seven" pattern, where a 1 is followed by seven zeros); **lpbk** (loopback); **300 Hz** (steady 300 Hz tone); **1KHz** (steady 1 kHz tone); and **3KHz** (steady 3 kHz tone).

When the circuit is saved, the system will send the selected pattern toward the first end of the circuit on each time slot, to facilitate testing. When circuit testing is finished, reset the Test field to the "off" position. The **lpbk** (loopback) option loops the circuit back toward the first WAN link specified.

If you have a voice cross-connect circuit (with or without signaling), you can access these capabilities from the WAN Cross-Connect Screen. See the review at the end of this section for more information.

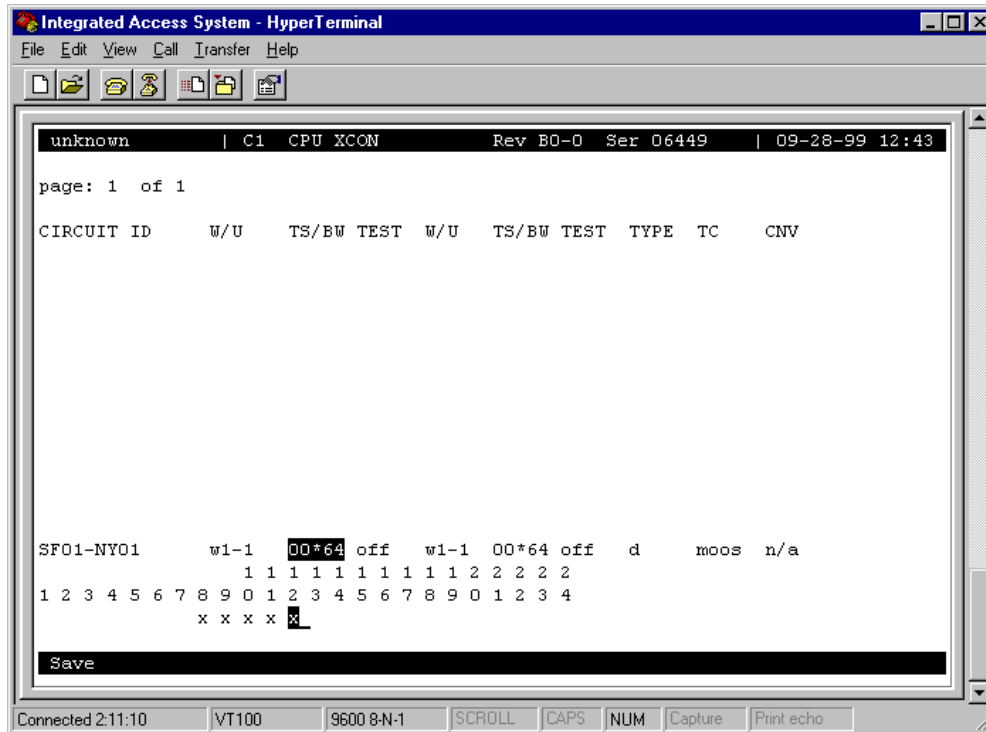

Figure 4-30. Test Options

W/U

The second WAN Unit column is the T1/E1 link in which the pass-through connection ends. The options are all of the WAN cards and ports. If a WAN card is not present in the W/U selected, an error message is generated. Figure 4-30 shows the selection of W 3-2.

TS/BW

The second Time Slot/Band Width column shows the different time slots from WAN 3-2 that will be assigned to this pass-through connection. Figure 4-30 shows the selection of 5 time slots from WAN 3-2 assigned to the end of the connection. Any number of time slots from **1-24** would be accepted for T1 operations and from **1-15 and 17-31** for E1 operations. The bandwidth is automatically assigned.

Make your selection with the space bar and arrow keys. The arrow key moves from slot to slot, and the space bar toggles between selecting and deselecting the time slot. *The number of DSO time slots assigned to this half of the cross-connect circuit must equal the number assigned to the other. Otherwise, the system will reject the connections and generate an error message.*

TEST

The second Test column lets you select the test pattern to be applied to this circuit toward the second WAN link specified. Figure 4-30 shows the option set to **off**. Like the previous Test column, the choices are **off** (no testing); **all 0** (all zeros); **all 1** (all ones); **m_oos** (Multiplexer Out Of Synchronization); **1:1** (a 1 followed by one zero); **1:7** (a zero is followed by a 1 and six more zeros); **lpbk** (loopback); **300 Hz** (steady 300 Hz tone); **1KHz** (steady 1 kHz tone); and **3KHz** (steady 3 kHz tone).

When the circuit is saved, the system will send the selected pattern toward the second end of the circuit on each time slot, to facilitate testing. When circuit testing is finished, reset the Test field to **off**. The Loopback (**lpbk**) option loops the circuit back toward the first WAN link specified.

Users dealing with a voice cross-connect circuit (with or without signaling) can access capabilities from the WAN cross-connect screen. See the review at the end of this section.

TYPE

The Type column selects the type of pass-through circuit, as shown in Figure 4-30. The choices are **v** (voice); **v&s** (voice with signaling), and **d** (data). Use **v** for a voice circuit that does not require trunk conditioning. Use **v&s** for a voice circuit with signaling. This option preserves A/B (robbed-bit) signaling on the selected time slots and provides trunk conditioning. Use **d** for data circuits, which also support trunk conditioning.

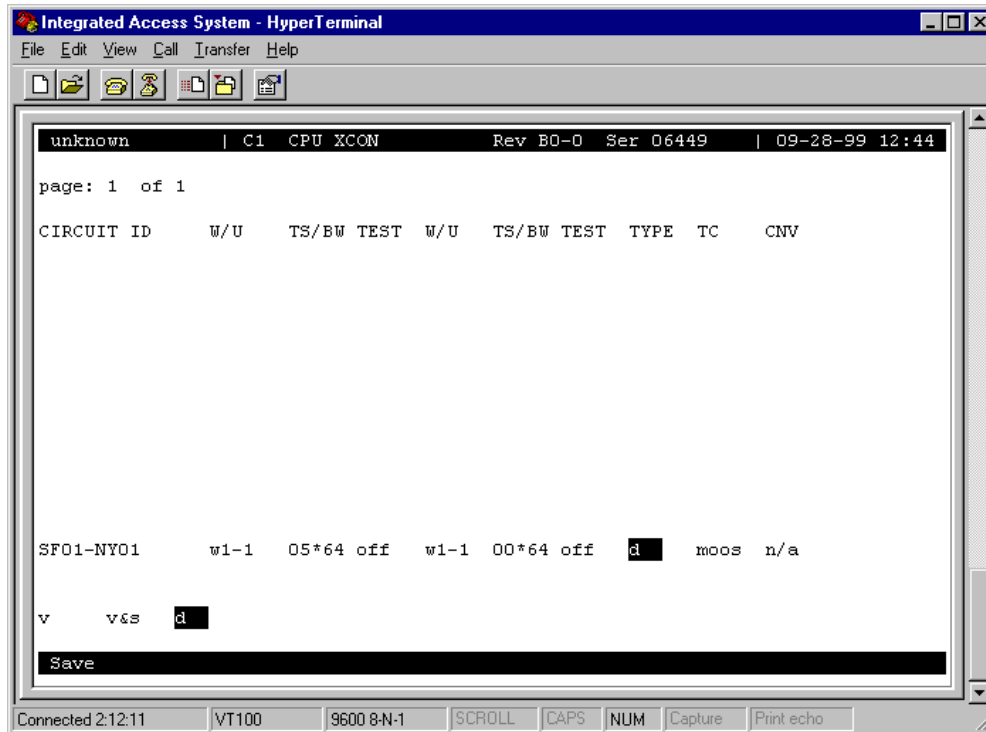

Figure 4-31. Cross-Connect Circuit Type Selection

TC

You can define the pattern to be transmitted on a cross-connected circuit if one of the circuit's two WAN links fails. This is known as Trunk Conditioning (TC), and the available selections depend on the Type column setting.

If the Type setting is **d** (data), no TC choice is available and the system automatically shows **moos**. An example of this is shown as Figure 4-31.

If the Type setting is **v&s** (voice with signaling), the TC choices are shown in Figure 4-32. They are as follows: **user** (user-defined bit pattern), **e&m** (trunk signaling), **fxsl** (foreign exchange station-loop-start), **fxsg** (foreign exchange station ground-start), **fxsd** (foreign exchange station-defined network), **plar** (private-line automatic ringdown), **dpo** (dial-pulse originating), **fxol** (foreign exchange office loop-start), **fxog** (foreign exchange office ground-start), **fxod** (foreign exchange office-defined network), **dpt** (dial-pulse terminating) and **mrd** (manual ringdown).

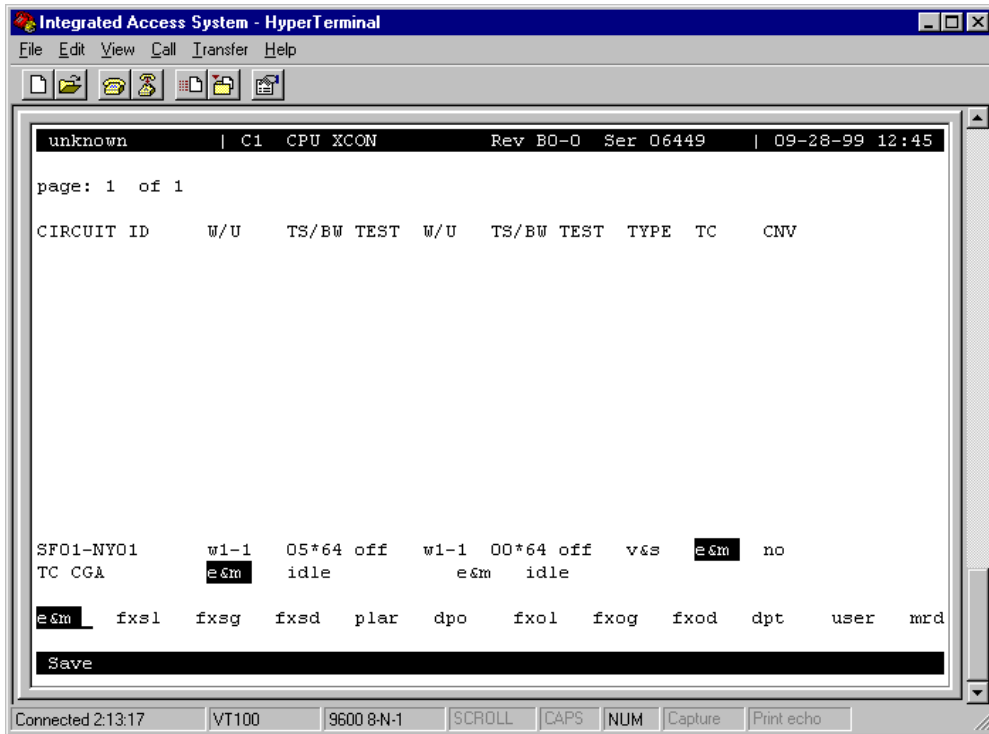

Figure 4-32. Trunk Conditioning Option Selection

If you choose **user**, also enter a two-digit hexadecimal code for the bit pattern to be sent in each direction. Each digit can be from **0** to **9** or **a** to **f**. Figure 4-33 shows a typical signaling bit pattern entry screen.

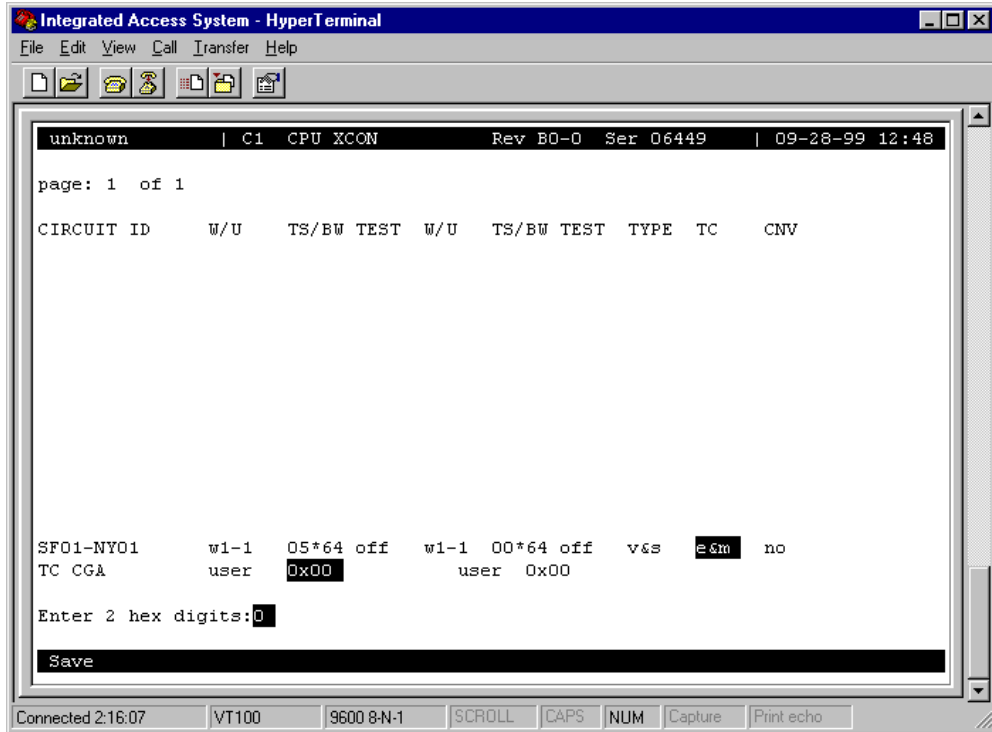

Figure 4-33. Signaling Bit Pattern Selection

For **v** (voice), no TC choice is available, so the system always shows **n/a** (not applicable). This is shown as Figure 4-34.

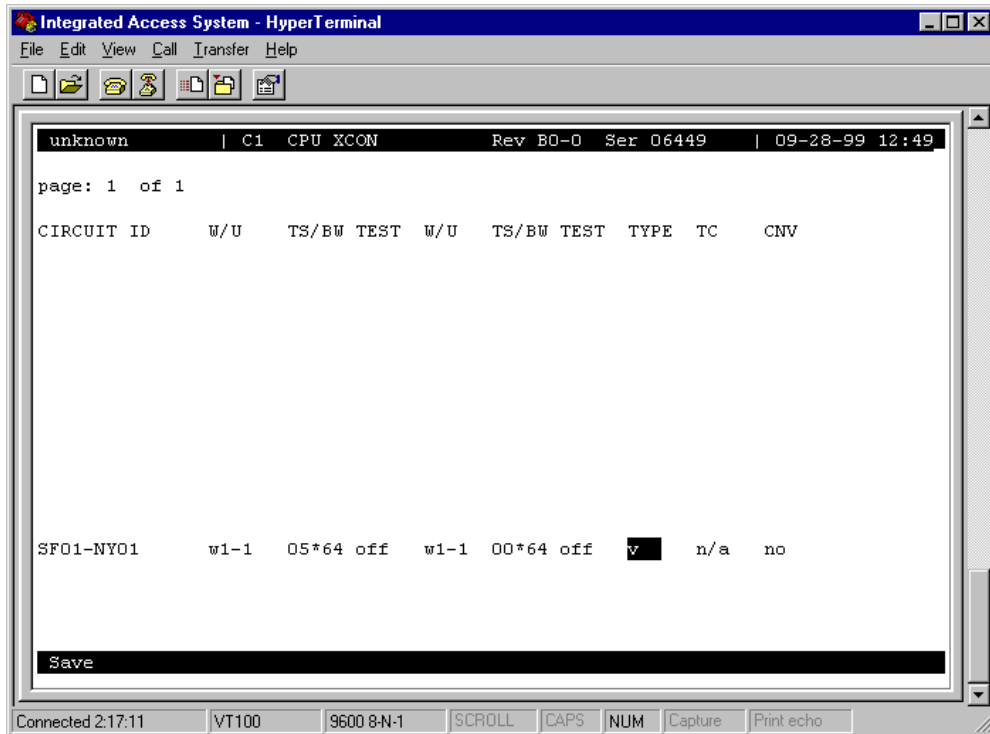

Figure 4-34. Voice Options Screen

CNV

The Conversion (CNV) parameter allows you to request that PCM companding and signaling conversion be performed on this cross-connect circuit. Since these conversions only apply to voice circuits, if the TYPE selected is **d** (data), then the only acceptable value here is **n/a**. Similarly, if the TYPE selected is **v** (voice without signaling), the system will only allow users to request PCM companding conversion. If the TYPE is **v&s** (voice with signaling), then users can select any combination of companding and/or signaling conversion.

If the TYPE is **v** or **v&s**, the system will first ask users to "Select PCM CONV:" for defining the type of companding conversion users require (see Figure 4-35). The options are no companding conversion (**none**), convert the incoming **A-mu** (A-law signal to mu-law) and convert the incoming **mu-A** (mu-law signal to A-law).

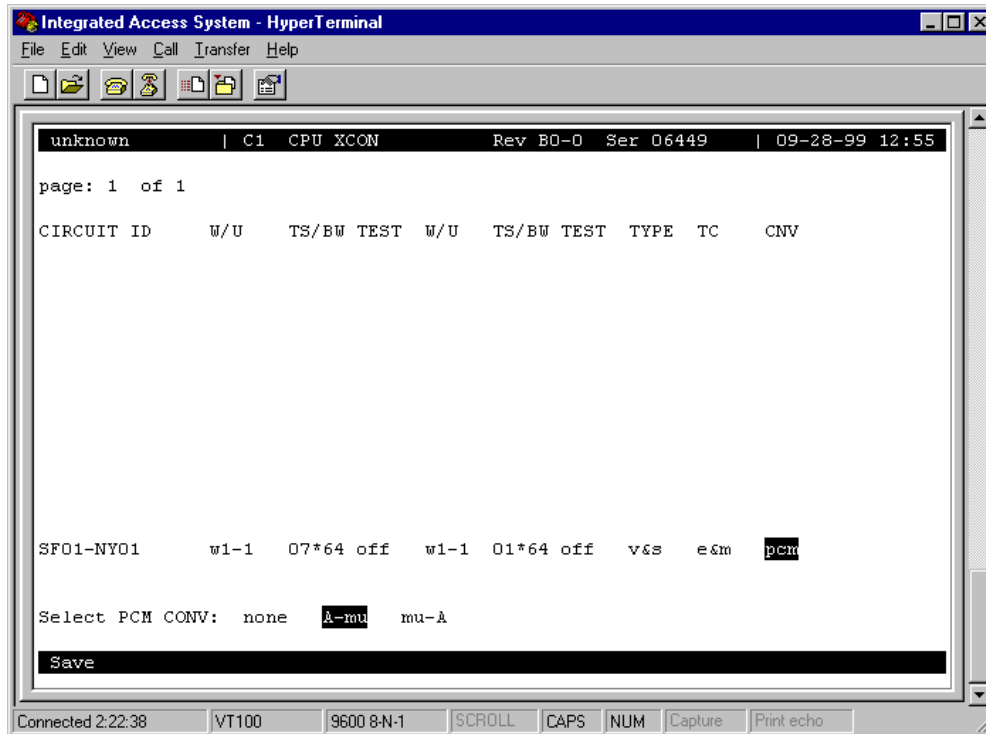

Figure 4-35. Selecting PCM Conversion

If the TYPE is **v&s**, the system will prompt users to "Select SIG CONV:" for selecting the type of signaling conversion needed (see Figure 4-36). The option **none** (default signaling conversion) is where a bit pattern of "0000" will automatically be converted to "0001" in the T1-to-CEPT E1 direction.

The **ANSI-CCITT** setting will convert the incoming ANSI signaling to CCITT signaling. Conversely, the **CCITT-ANSI** setting will convert the incoming CCITT signaling to ANSI signaling. These two options are complementary (i.e., if either is selected in one direction, the other is automatically selected for the reverse direction).

The **ABCD-ABAB** setting will convert the incoming CEPT signaling to T1 signaling for an ESF or D4 cross-connect. The **ABCD-AB01** option will convert the incoming T1 signaling to CEPT signaling for an ESF or D4 cross-connection. These two options are complementary (if either one is selected in one direction, the other is automatically selected for the reverse direction).

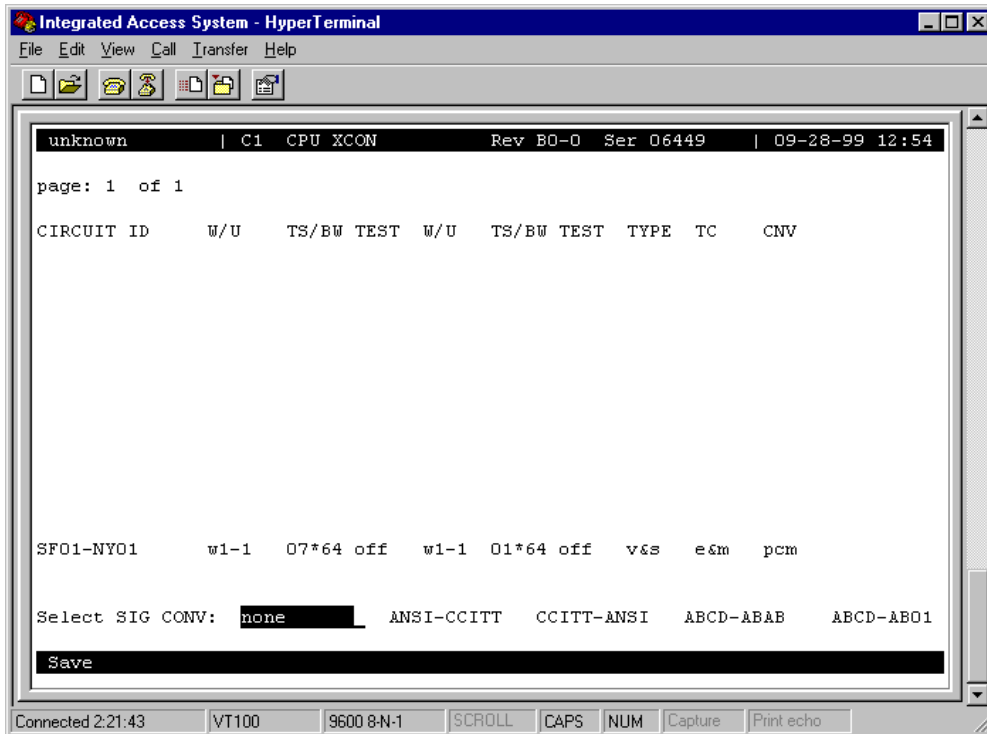

Figure 4-36. Selecting Signaling Conversion

Due to space limitations in the CNV column on the screen, the system will display a summary notation of the choices just made. The possible values are **no** (no conversion), **sig** (signaling is converted, but not the PCM), **pcm** (PCM is converted, but not the signaling) and **p&s** (both signaling and PCM are converted). Figure 4-37 shows those options.

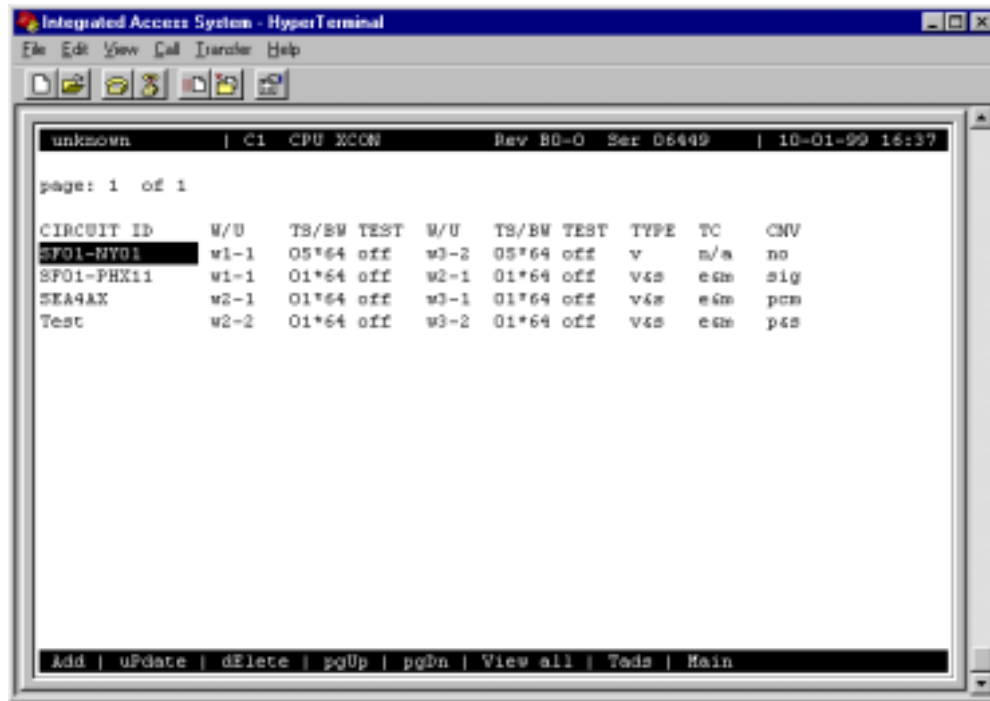

Figure 4-37. Typical Completed Circuits

4.19 Cross-Connect Actions

Table 4-5 summarizes the actions you can perform from the CPU Cross-Connect Screen. These actions appear at the bottom highlighted line of the screen.

Table 4-5. CPU Cross-Connect Screen Actions

Action	Function
Add	Allows you to program additional pass-through cross-connects in the system. If mistakes are made during the add process, pressing the up arrow or down arrow key will terminate this operation.
uPdate	Initiated by pressing the "p" key. With this command, users can change any of the parameters of a pass-through connection. Use the arrow keys to highlight the area to be changed and close the transaction using the "s" (Save) command.
dElete	Initiated by pressing the "e" key. Use this command to delete existing pass-through connections. The system will prompt users to delete the circuit, and the "y" key must be pressed to complete the transaction.

pgUp	Initiated by pressing the "u" key. Since the system can handle many different cross-connect circuits, users may exceed a single screen. New pages will be added automatically to accommodate additional circuits. The page count feature at the top of the screen shows the current page and the total amount of cross-connect pages. Use this command to scroll up through the pages of cross-connect information.
pgDn	Initiated by pressing the "d" key. This action is similar to the pgUp command. Use this command to scroll down through the pages of cross-connect information.
View all	The View all action is initiated by pressing the "v" key. This action is used to access the Broadcast screen discussed in a later section.
Tads	Test Access Digroups is a remote test access for data cross connects that pass through the system.
Save	Once the pass-through connection is defined, pressing "s" (Save) will cause the circuit to be established and will update the WAN cards involved.

To update a cross-connected circuit from the CPU Cross-Connect Screen, highlight the circuit name to be updated, and press "p" to invoke the **uPdate** command. Figure 4-38 shows the WAN card in TS (time slot) 8 through 12 being updated. However if the WANs are selected and deleted as shown in Figure 4-39 then the screen in Figure 4-38 will be blank for WAN TS 8 through 12.

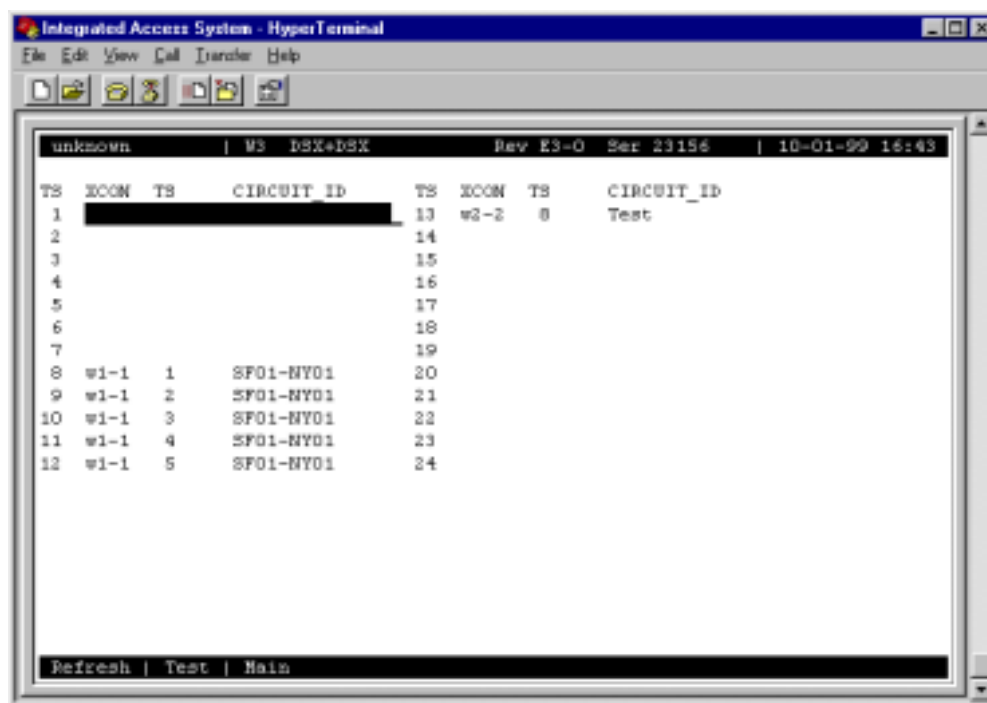

Figure 4-38. Updated WAN Card Screen

To delete a cross-connected circuit from the CPU Cross-Connect Screen, highlight the circuit name to be deleted, and press "e" to invoke the **dElete** command. Figure 4-39 shows the deletion process.

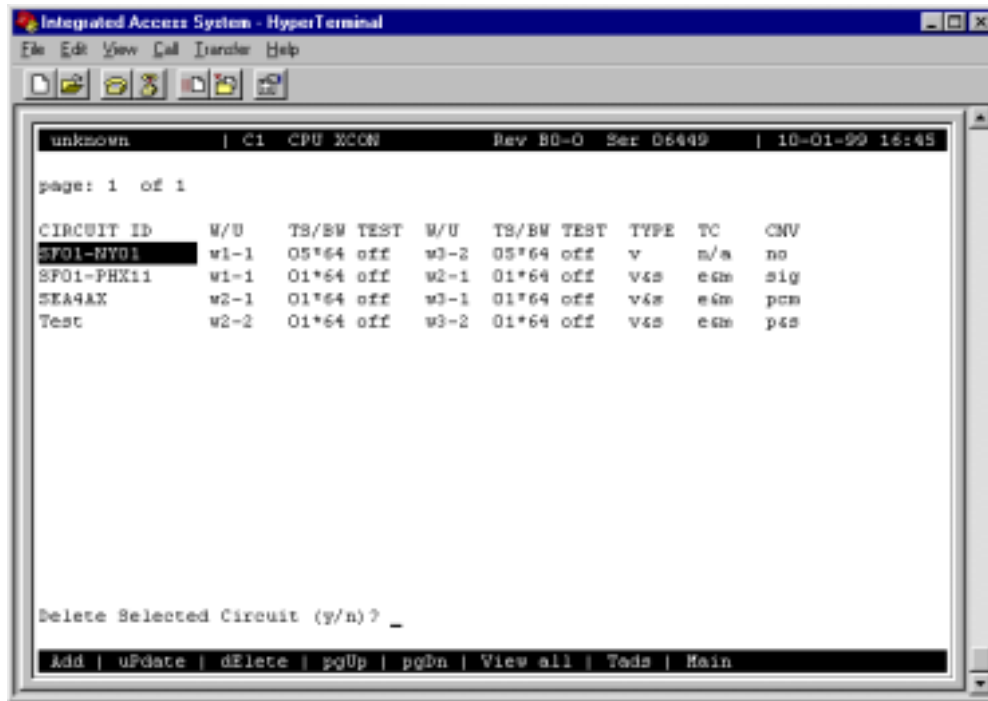

Figure 4-39. Delete Cross-Connection Screen

4.20 Testing Voice Cross-Connects

Voice and data circuits differ in the way the test function is accessed. While you can set up test patterns on data circuits on the cross-connect screen from the System Main Screen, you must use a subscreen of the WAN Cross-Connect Card Screen for circuit testing. Figure 4-40 shows the error message that appears when you attempt to test voice circuits from the CPU Cross-Connect Screen.

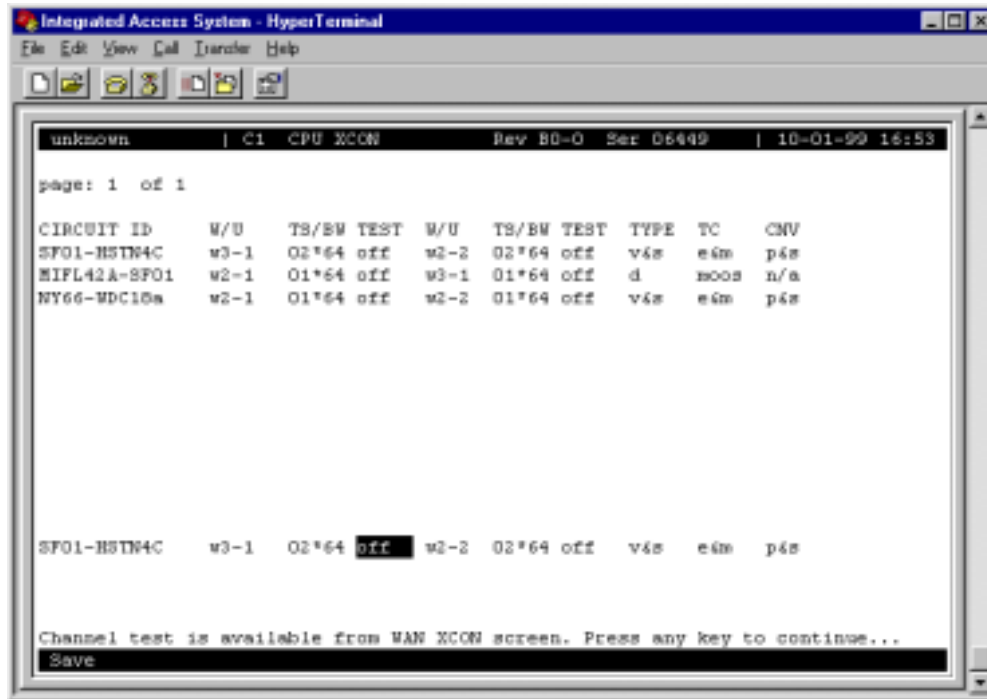
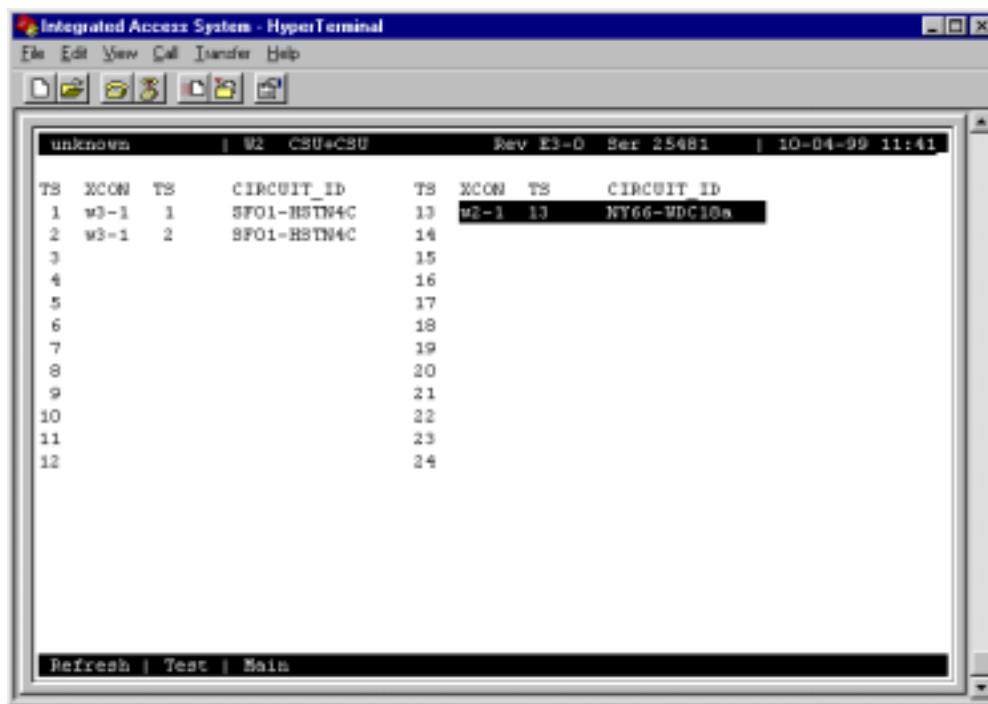

Figure 4-40. Typical Message on a CPU Cross-Connect Screen

Figure 4-41 shows the WAN Cross-Connect Screen for the voice circuit used in this example. Place the cursor over the selected circuit and press the "t" key to bring up the Test Screen shown in Figure 4-42. This screen now splits the circuit into two parts, with the location acting as the midpoint. The first column of test parameters will apply to that portion of the circuit on port w2-1, time slot 13. The second column of test parameters will apply to that portion of the circuit on port w2-2, time slot 13.

Table 4-6 lists the test parameters and their available and default values.



The screenshot shows a HyperTerminal window titled "Integrated Access System - HyperTerminal". The window contains a menu bar (File, Edit, View, Call, Transfer, Help) and a toolbar. The main display area shows a terminal session with the following text:

```
unknown | W2 CSU+CSU Rev E3-0 Ser 25481 | 10-04-99 11:41
```

TS	XCON	TS	CIRCUIT_ID	TS	XCON	TS	CIRCUIT_ID
1	w3-1	1	SFO1-HSTN4C	13	w2-1	13	NY66-MDC10a
2	w3-1	2	SFO1-HSTN4C	14			
3				15			
4				16			
5				17			
6				18			
7				19			
8				20			
9				21			
10				22			
11				23			
12				24			

At the bottom of the terminal window, there is a status bar with the text "Refresh | Test | Main".

Figure 4-41. Highlighted Circuit on a WAN Cross-Connect Screen

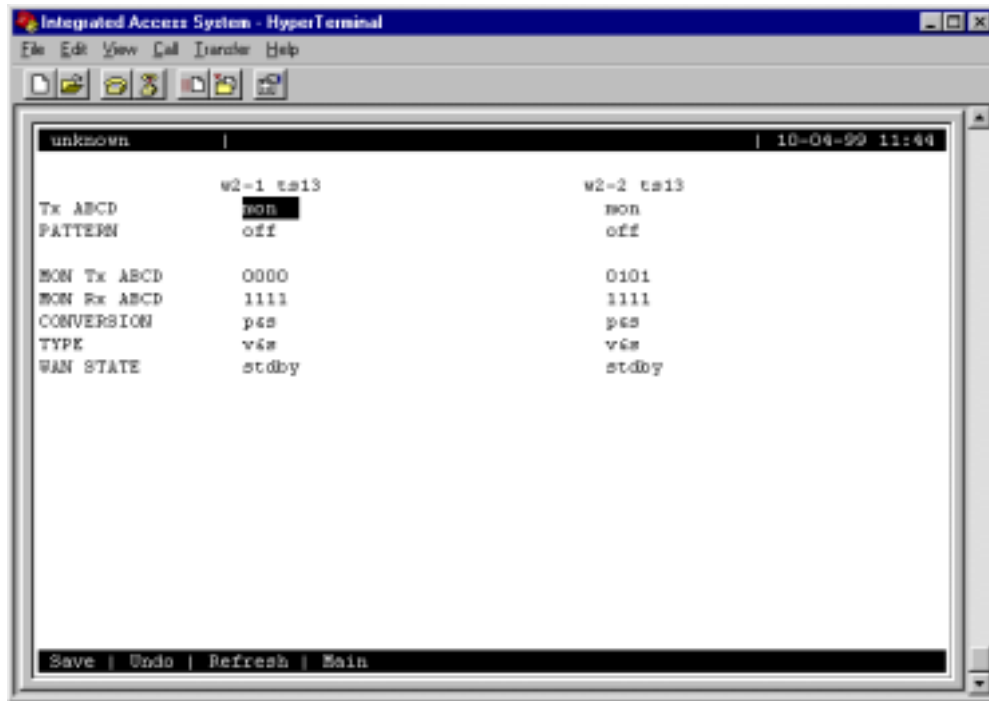

Figure 4-42. Typical Test Screen and ABCD Bit Options

Table 4-6. WAN Cross-Connect Test Screen Options

Parameter	User Options	Default
Tx ABCD	mon set	mon
PATTERN	off all0 all1 m_oos 1:1 1:7 lpbk 300Hz 1KHz 3KHz	off
MON Tx ABCD	information only—no user options	
MON Rx ABCD	information only—no user option	
CONVERSION	information only—no user option	
TYPE	information only—no user option	
WAN STATE	information only—no user option	

Tx ABCD BITS

The Transmit ABCD bit parameter has two options: **mon** (allowing you to observe the bit pattern being sent on the transmit side of the line), and **set** (to choose a different pattern for testing that portion of the circuit). Choosing **set** brings up a small four-character window at the bottom of the screen, where you can type in a new pattern of ones and zeros.

Figure 4-43 shows a diagram of the test process. When Tx ABCD for w2-1 is set to **mon**, the w2-1 column reflects the ABCD bits being sent out on w2-1. This pattern should be identical to Rx ABCD on w2-2, unless the conversion table is used. When Tx ABCD for w2-1 is

optioned to **set**, users supplies a bit pattern of four 1s and 0s for the new ABCD bits. The Rx ABCD stream from w2-2 is broken at circle #1, and the new pattern is inserted into the Tx ABCD stream. The same applies for **mon** and **set** for w2-2. The bitstream will be broken at circle 2.

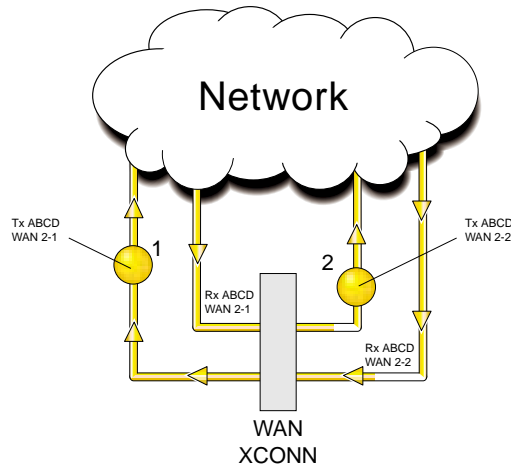

Figure 4-43. Voice Test Diagram

PATTERN

The Pattern parameter allows you to choose a test pattern to be transmitted as PCM data on the selected side of the circuit. The options are **off**, **all 0** (zero), **all 1** (one), **m_oos** (multiplexer out of synchronization), **1:1** (a 1 followed by a zero and then another 1), **1:7** (a zero followed by a 1 and seven zeros, then another 1), **lpbk** (loopback), **300 Hz** (300 Hz tone), **1KHz** (1 kHz tone) and **3KHz** (3 kHz tone). Since Tx ABCD only changes signaling bits, this option allows you to choose the test pattern. You can send a different pattern toward either side of the circuit.

Mon Tx ABCD

The Monitor Transmit ABCD bit information field shows the ABCD bit pattern being transmitted on the outbound circuit. You can change it by using the **set** command. *This parameter is for information only.*

Mon Rx ABCD

The Monitor Receive ABCD bit information field allows you to observe the bit pattern being received on the inbound circuit. *This parameter is for information only; you cannot change it.*

CONVERSION

The Conversion information field shows users the conversion setting selected from the cross-connect screen. The possible values are **no** (no conversion), **sig** (signaling is converted, but not the PCM), **pcm** (PCM is converted, but not the signaling) and **p&s** (both signaling and PCM are converted). *This parameter is for information only; you cannot change it.*

TYPE

The Type information field show you the type of circuit (**v** for voice or **v&s** for voice and signaling).

WAN STATE

The WAN State information field shows the current status of the port. The possible values are **stdby**, **actv**, **test** (the user is actively controlling the circuit), **OOS** (WAN port is Out of Service), and **CGA** (WAN port has a CGA alarm). *This parameter is for information only; you cannot change it.*

4.21 Using the Broadcast Option

One of the special features of WAN time slot assignment in cross-connect systems is the ability to copy a data signal and send it to multiple locations without disturbing the original circuit. This feature is called *broadcasting*, which means “multi-cast” (not to be confused with broadcast-quality video transmission).

For example, assume that a major company has a video lecture transmitted from the corporate headquarters in Denver to the sales office in San Francisco. The sales offices in Salt Lake City, Houston, and Phoenix would also like to view the lecture.

The master circuit (Denver to San Francisco) is a two-way circuit (i.e., both ends can send and receive data). The other ends of the broadcast circuits (the sales offices in Salt Lake City, Houston and Phoenix) will only be able to receive the output of the Denver end of the master circuit. That is, they will not be able to participate in the live discussion.

The following series of figures shows how the process works.

Figure 4-44 shows the Main Cross-Connect screen. In this example, T1 circuits connected at the Denver office go to San Francisco (**w1-1**), Houston (**w1-2**), Salt Lake City (**w2-1**), and Phoenix (**w2-2**).



Note: The screen only shows the cross-connects made from WAN cards to WAN cards, not from user cards to WAN cards.

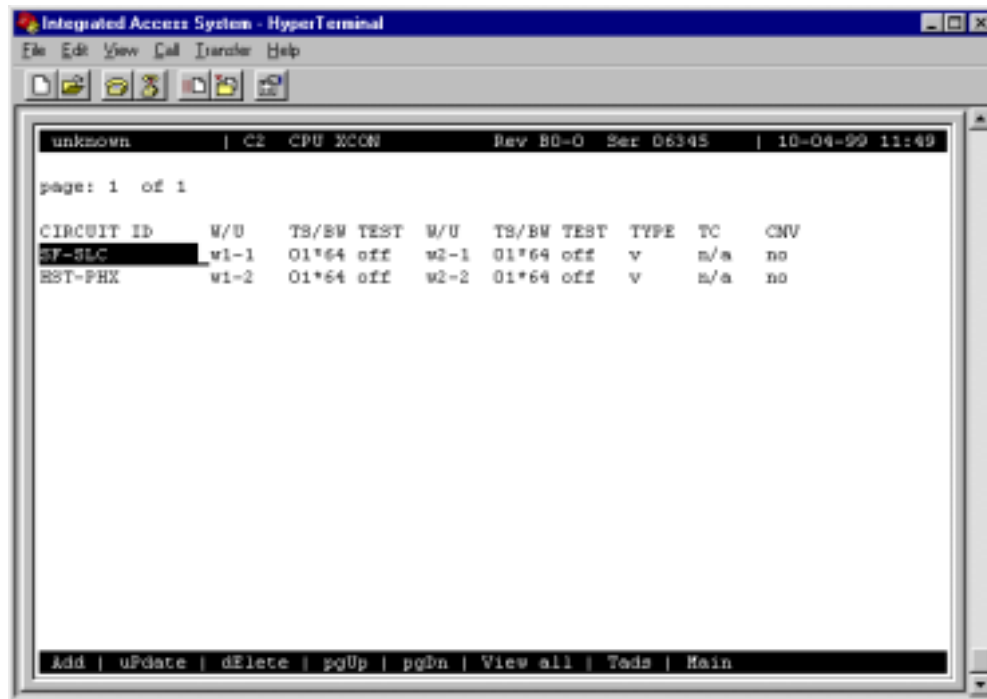

Figure 4-44. Typical Main Cross-Connect Screen

Broadcast circuits can be initiated, updated, or deleted only from the broadcast screen.

To access the Broadcast option, press "v" (for **View all**) in the Main Cross-Connect Screen. The All Circuits Screen of Figure 4-45 appears. In addition to the WAN card-to-WAN card cross-connects, this screen also shows all user card-to-WAN card time slot assignments **for all WAN cards**.

Because this screen shows all WAN time slots that are either assigned to user cards or cross-connected to other time slots, it may be filled with data.

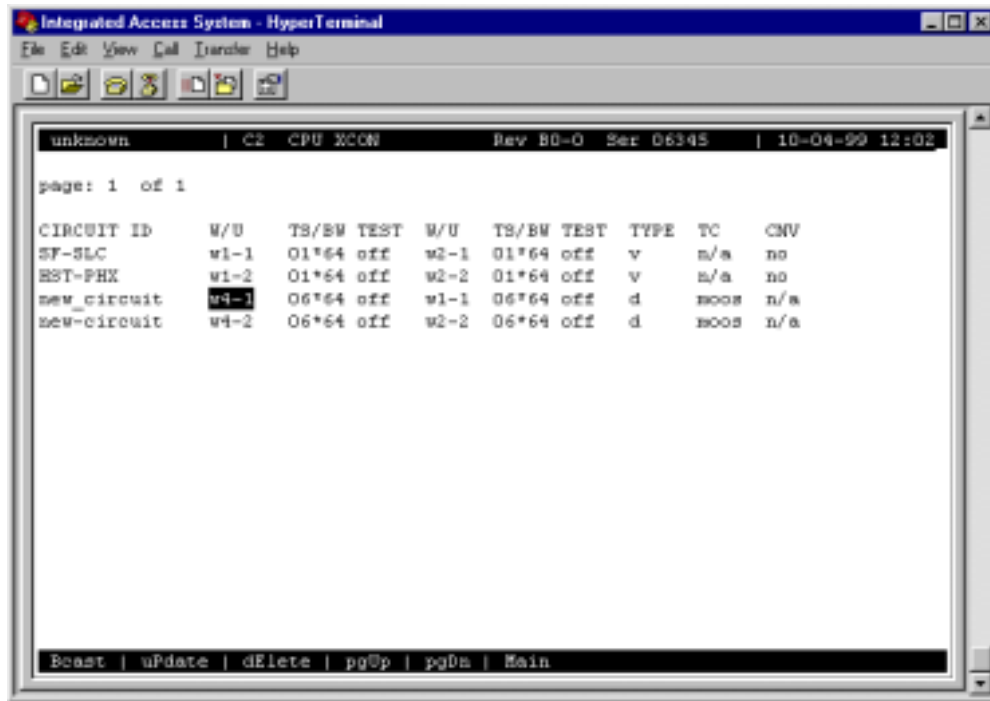

Figure 4-45. Typical All Circuits Screen

In addition to the two WAN-to-WAN cross-connects shown in Figure 4-44, an HSU circuit from slot U4-1 to the San Francisco T1 circuit (on WAN 1-1), and an HSU circuit from slot U4-2 to Phoenix (on WAN 2-2) are shown in Figure 4-45.

To select the broadcast option, place the cursor over the User card circuit that will be copied. In this case, it will be the Denver end of the Denver-to-San Francisco link on WAN 1-1. Then, press the "**b**" (**Bcast**) key from the actions at the bottom of the screen.

The screen of Figure 4-45 shows the dynamics of the first copy of that circuit. Press the <Enter> key to access and modify the connection options.

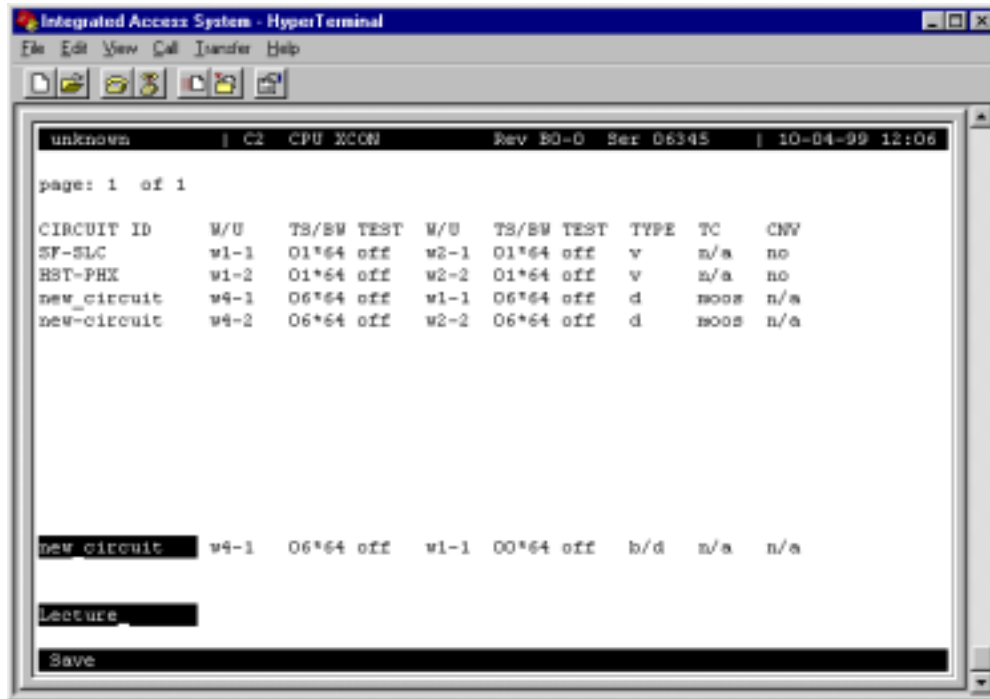

Figure 4-46. Typical Add Broadcast Screen

In this example, the broadcast circuit is named "Lecture" for easier identification later, when the circuit will be disconnected.

Figure 4-46 shows the selection of a second destination for the broadcast circuit. In that example, that destination is Salt Lake City, which is accessed through **w2-1**. The time slot selection is shown in Figure 4-46. Press "**s**" (**Save**) to save the parameters of the new circuit. Figure 4-49 shows the new circuit, whose type is **b/d** (broadcast/data).

Use similar actions to duplicate this circuit for the other destinations. Figure 4-47 shows the completed circuits.

To disconnect the circuits when the program is finished, highlight the circuit to be disconnected and press the "**e**" key. The screen shown in Figure 4-51 will appear. Then, select "**y**" to permanently delete the copied circuit while leaving the original circuit intact.

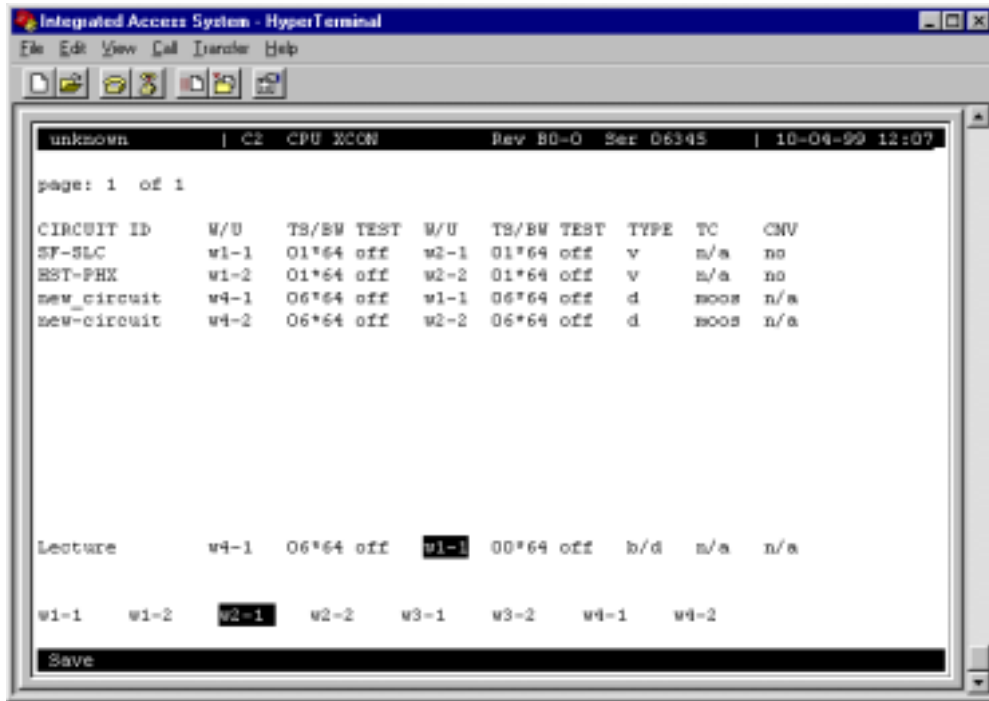

Figure 4-47. Typical "To" Destination Selection

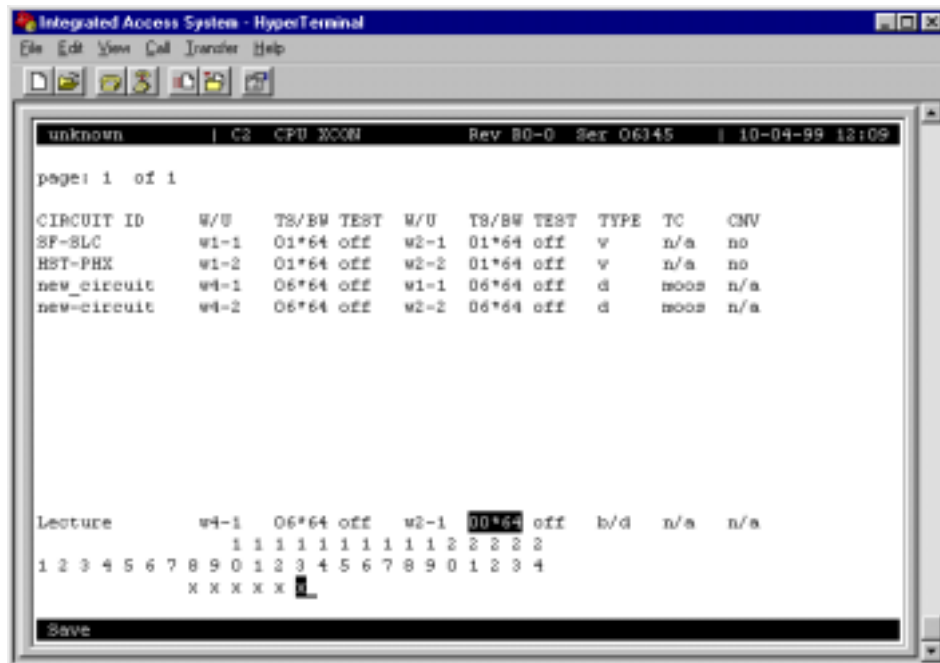

Figure 4-48. Typical Time Slot Selection

```

Integrated Access System - HyperTerminal
File Edit View Call Transfer Help

unknown | C2 CPU XCON Rev B0-0 Ser 06345 | 10-04-99 12:10

page: 1 of 1

CIRCUIT ID  W/U  TS/BW TEST  W/U  TS/BW TEST  TYPE  TC  CNV
SF-SLC      w1-1  01*64 off   w2-1  01*64 off   v     n/a no
HST-PHX     w1-2  01*64 off   w2-2  01*64 off   v     n/a no
new_circuit w4-1  06*64 off   w1-1  06*64 off   d     moos n/a
new_circuit w4-2  06*64 off   w2-2  06*64 off   d     moos n/a
Lecture     w4-1  06*64 off   w2-1  06*64 off   b/d   n/a  n/a

Bcast | uPdate | dElete | pgUp | pgDn | Main

```

Figure 4-49. Typical Complete Broadcast Circuit

```

Integrated Access System - HyperTerminal
File Edit View Call Transfer Help

unknown | C2 CPU XCON Rev B0-0 Ser 06345 | 10-04-99 12:17

page: 1 of 1

CIRCUIT ID  W/U  TS/BW TEST  W/U  TS/BW TEST  TYPE  TC  CNV
SF-SLC      w1-1  01*64 off   w2-1  01*64 off   v     n/a no
HST-PHX     w1-2  01*64 off   w2-2  01*64 off   v     n/a no
new_circuit w4-1  06*64 off   w1-1  06*64 off   d     moos n/a
new_circuit w4-2  06*64 off   w2-2  06*64 off   d     moos n/a
Lecture     w4-1  06*64 off   w2-1  06*64 off   b/d   n/a  n/a
Lecture     w4-1  06*64 off   w1-2  06*64 off   b/d   n/a  n/a
Lecture     w4-1  06*64 off   w2-2  06*64 off   b/d   n/a  n/a

Bcast | uPdate | dElete | pgUp | pgDn | Main

```

Figure 4-50. Three Broadcast Circuits

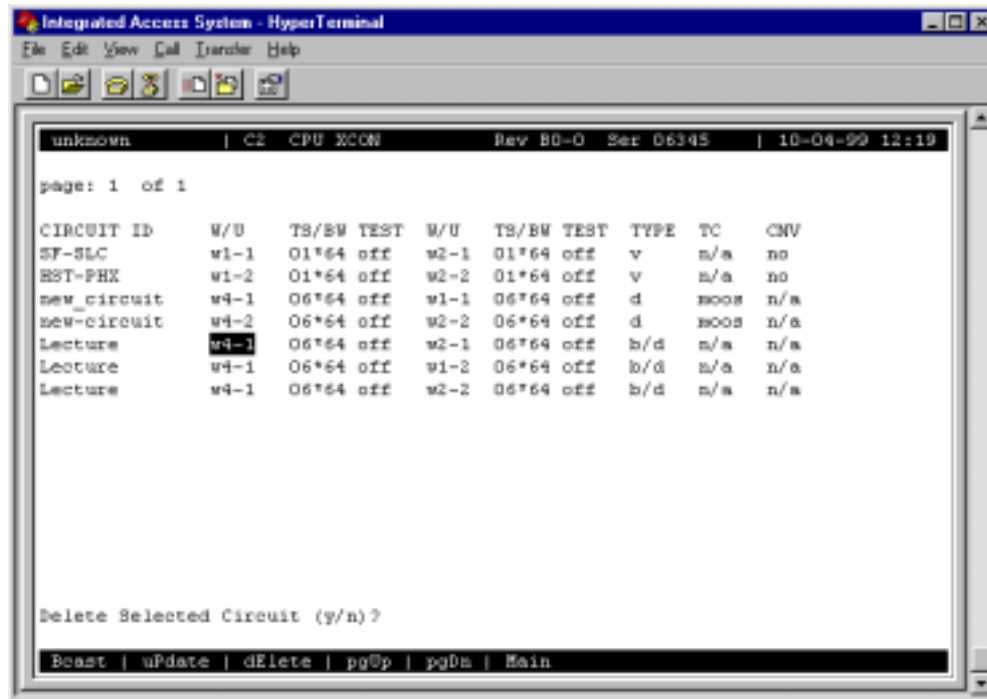

Figure 4-51. Typical Deleted Broadcast Circuit

4.21.1 WAN Link to WAN Link

Circuits from a WAN link to another WAN link can also be duplicated from the broadcast screen. Use the same procedure to establish multiple connections for WAN-to-WAN circuits.

In Figure 4-47, highlighting the WAN link circuit on slot w1-1 allows you to cross-connect duplicate information to any other WAN link.

4.21.2 Broadcast Screen Actions

Table 4-7 lists the actions you can perform in the Broadcast Screen. These actions appear on the bottom highlighted line of that screen.

Table 4-7. Broadcast Screen Actions

Action	Function
Bcast	Bcast allows users to program additional broadcast cross-connects in the system. If mistakes are made during the add process, pressing the up arrow or down arrow key will terminate this operation.

uPdate	The uPdate action is initiated by pressing the "p" key. With this command, users can change any of the parameters of a broadcast connection. Use the arrow keys to highlight the area to be changed and close the transaction using the "s" (Save) command.
dElete	The dElete action is initiated by pressing the "e" key. Use this command to delete existing broadcast connections. The system will prompt users to delete the circuit, and the "y" key must be pressed to complete the transaction.
pgUp	The pgUp (Page Up) action is initiated by pressing the "u" key. Since the system can handle many different circuits, users may fill the screen allotment for data. New pages will be added automatically to accommodate additional circuits. The page count feature at the top of the screen shows users the current page and the total amount of pages of information. Use this command to scroll up through the pages of cross-connect information.
pgDn	The pgDn (Page Down) action is initiated by pressing the "d" key. This action is similar to the pgUp command. Use this command to scroll down through the pages of cross-connect information.
Main	Pressing "m" (Main) will return users to the cross-connect screen.

4.21.3 Test Access Digroups (TADS)

The Test Access Digroups (TADS) is a remote test access for data cross connects that pass through the system according to publication TR-TSY-00033, Issue #1, June 1986.

A test center can access the system and assign split intrusive or non-intrusive monitor testing circuits between the unit and the test center via another WAN link. For the purpose of this discussion on Test Access Digroups, the figures show a 64kbps data circuit between Fremont, CA. and Jacksonville, FL. Figure 4-52 shows the cross-connect screen with the data circuits connected.

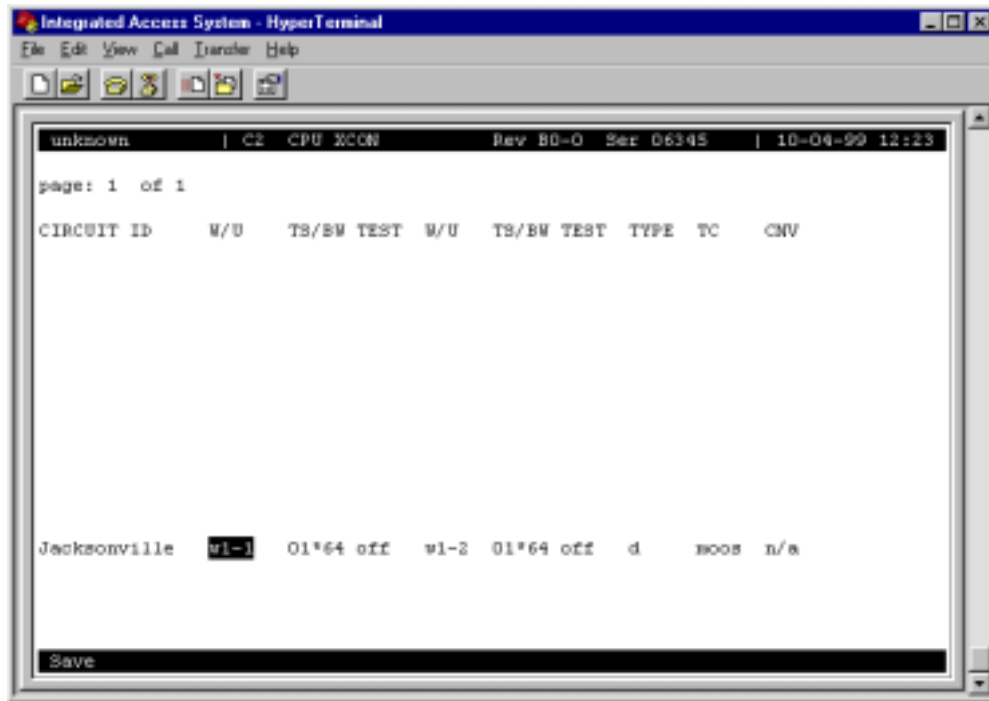

Figure 4-52. The TADS screen

In Figure 4-52, the data circuit called “Jacksonville” is connected on a single time slot between WAN1-1 and WAN1-2.

4.21.4 Monitor Circuit

With the monitor circuit, the data test center (by remote access) creates a “hitless” monitor connection (i.e., one that can be created, maintained and dropped without affecting the information on the circuit being tested) between the data test center and the Node_1 Device.

Highlighting the desired circuit and pressing the “N” key brings up the add monitor circuit screen shown in Figure 4-53.

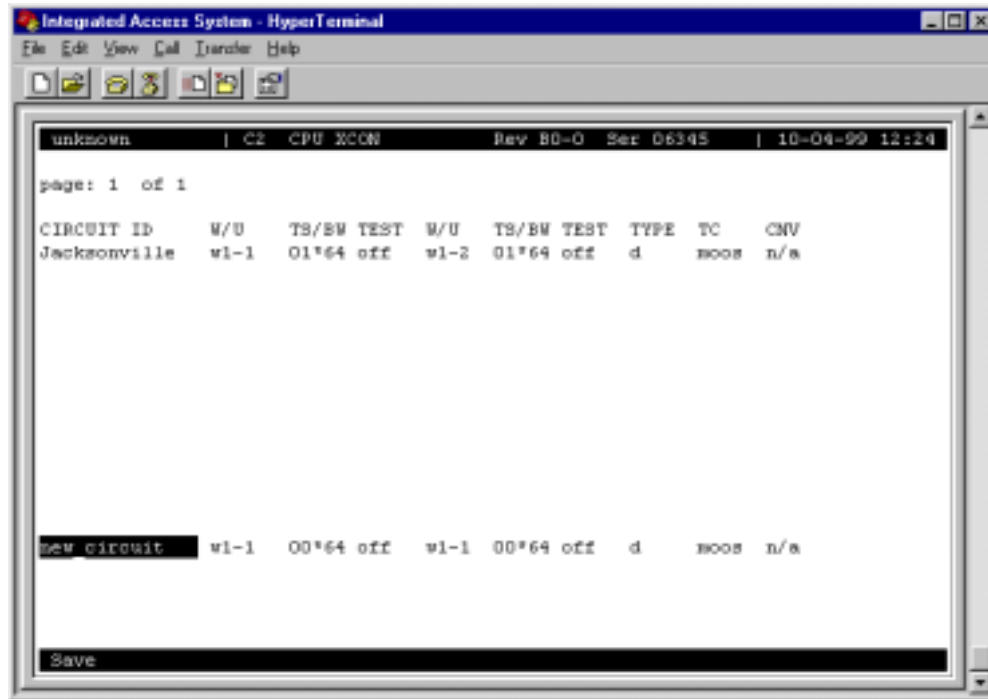
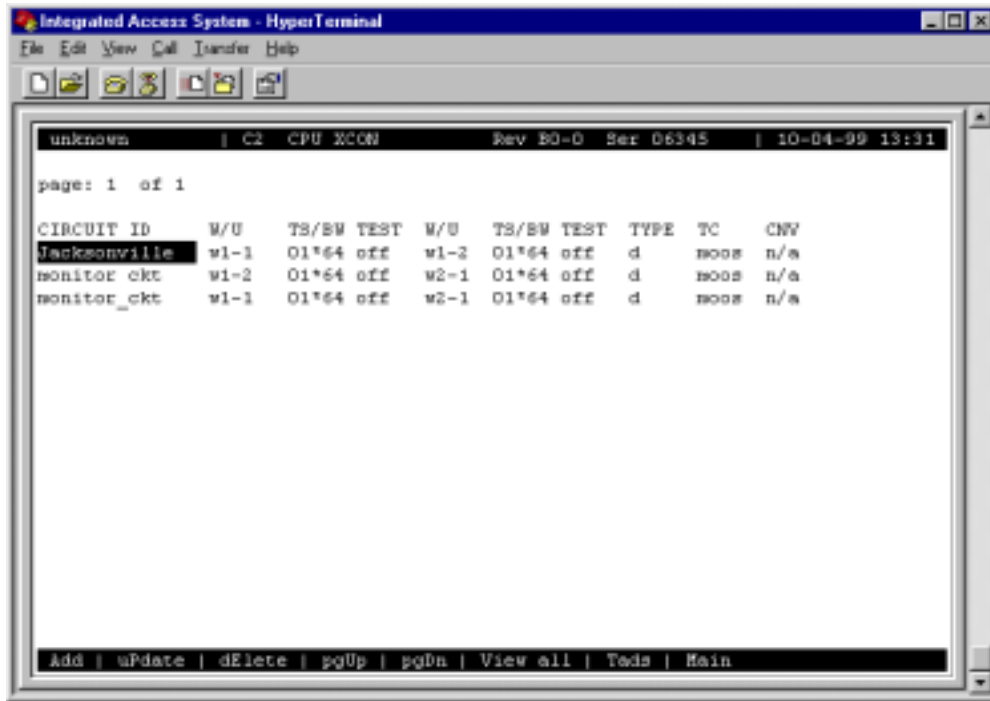

Figure 4-53. The Add Monitor Circuit Screen

Cross connect information is added in a similar fashion to the Add Broadcast screen mentioned previously. Figure 4-54 shows the completed monitor circuit.



The screenshot shows a HyperTerminal window titled "Integrated Access System - HyperTerminal". The window displays a command-line interface with the following text:

```
unknown | C2 CPU XCON Rev B0-0 Ser 06345 | 10-04-99 13:31  
page: 1 of 1  
CIRCUIT ID W/U TS/BW TEST W/U TS/BW TEST TYPE TC CNV  
Jacksonville w1-1 01*64 off w1-2 01*64 off d noos n/a  
monitor_ckt w1-2 01*64 off w2-1 01*64 off d noos n/a  
monitor_ckt w1-1 01*64 off w2-1 01*64 off d noos n/a
```

At the bottom of the window, there is a navigation bar with the following options: Add | uPdate | dElete | pgUp | pgDn | View all | Teds | Main.

Figure 4-54. Completed Monitor Circuit

Figure 4-55 shows a diagram of how the Monitor circuit splits the original cross connect circuit for testing.

Notice how the test circuit uses two 64kbps WAN time slots, one for the transmit side and one for the receive side of the line.

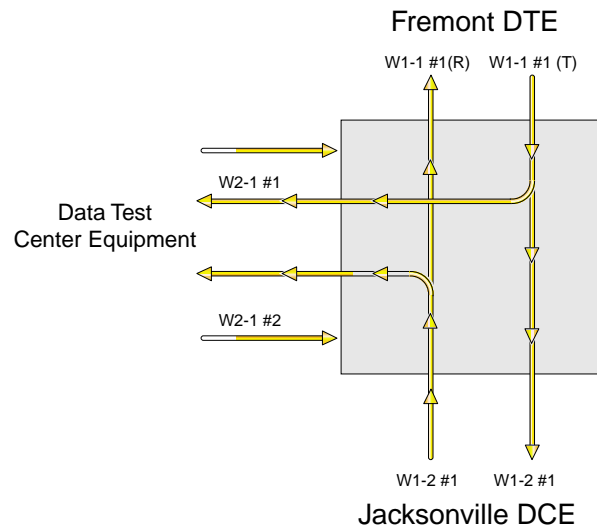

Figure 4-55. Monitor Circuit Diagram

4.21.5 Split Circuit

Pressing the “L” command from the Menu of Actions allows you to split the circuit through the data test center equipment. New circuit information is added in the same way as with the monitor circuit.

With the Split Circuit, the data test center splits the circuit and connects it to their equipment. Unlike the Monitor test circuit, the Split test circuit is intrusive and all transmit and receive data must pass through the equipment at the data test center.

Figure 4-56 shows the TADS screen with a split circuit completed. It uses two 64kbps time slots (like the Monitor circuit). Figure 4-57 shows a diagram of the split test circuit.

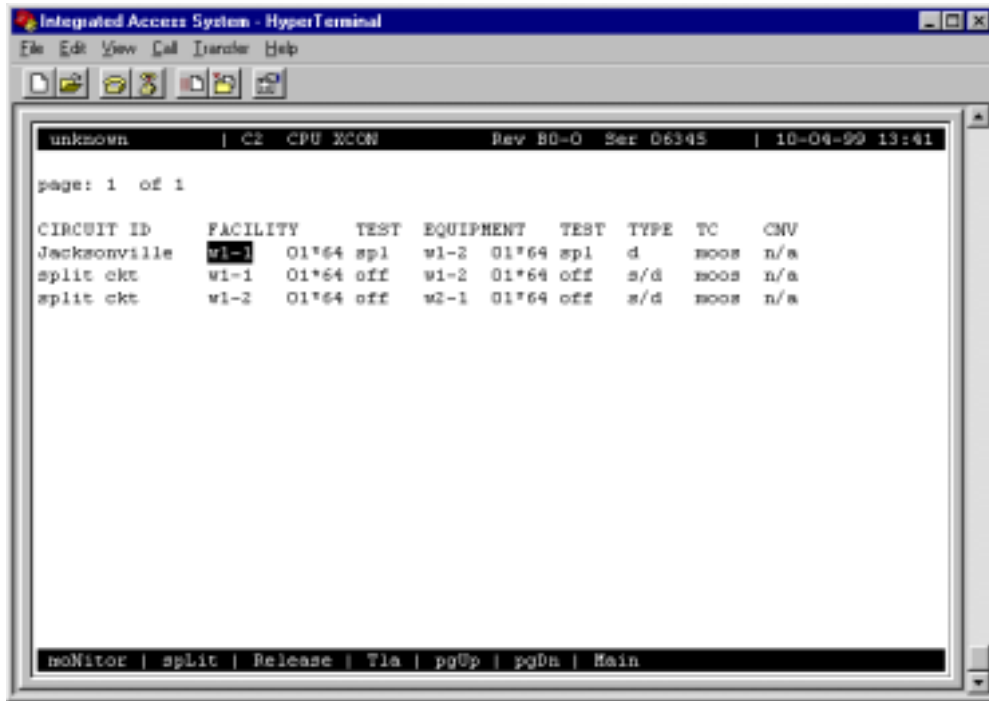

Figure 4-56. TADS Screen with Split Circuits

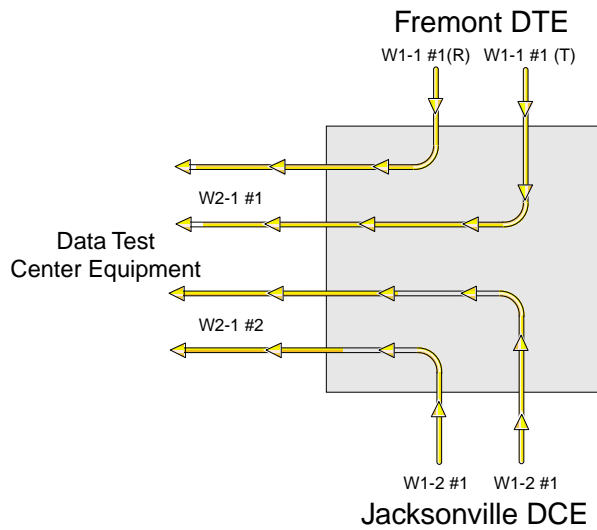

Figure 4-57. Split Circuit Diagram

4.21.6 Release

Pressing the “**R**” (**Release**) command allows you to release the circuit from the data test equipment. The system will verify the action desired with a yes/no question.

With the Release Circuit, the Data Test Center removes the connection between the circuit being tested and restores the circuit to its pre-accessed state.

Figure 4-58 shows the TADS screen with the release verification.

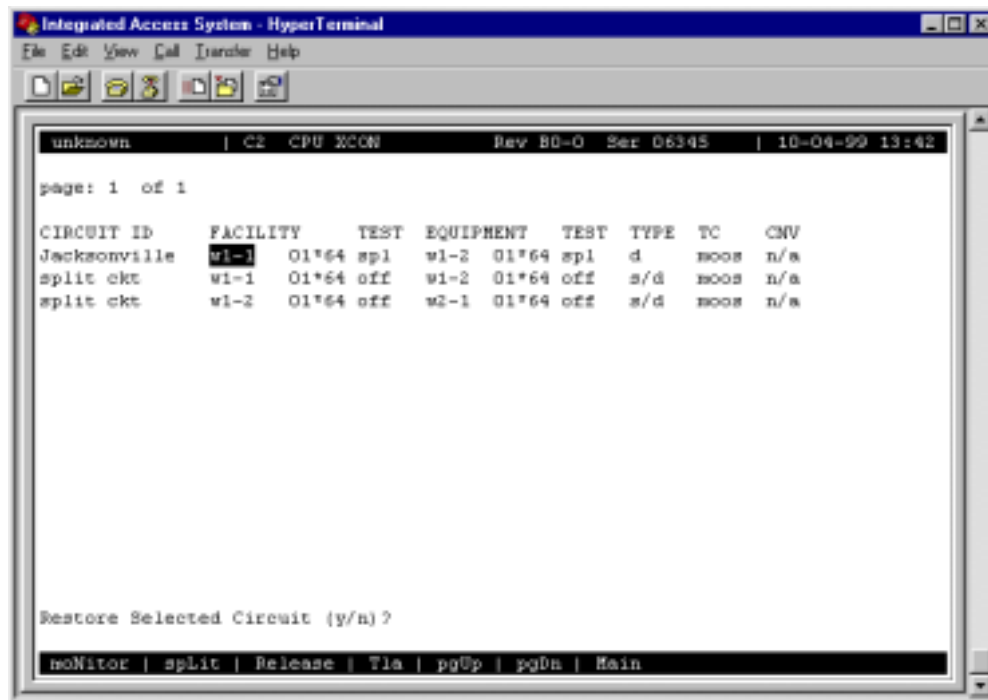

Figure 4-58. TADS Restore Circuit Screen

4.21.7 Terminate and Leave Access

The Terminate and Leave Access (TLA) circuit gives the data test center the capability to terminate one or both directions of transmission on a circuit by inserting an unassigned channel code (01111111) in the outgoing transmission path(s). The TLA feature is useful in circuit provisioning to turn circuits up and down remotely, and in testing multipoint circuits to isolate and remove noisy bridge legs from service.

Figure 4-59 shows the TLA screen with the choice of Monitor (**mon**) or Unassigned Channel Code (**uca**) to be applied to the highlighted circuit. (If TLA had been applied to a Split circuit, the choices would have been **spl** or **uca**.)

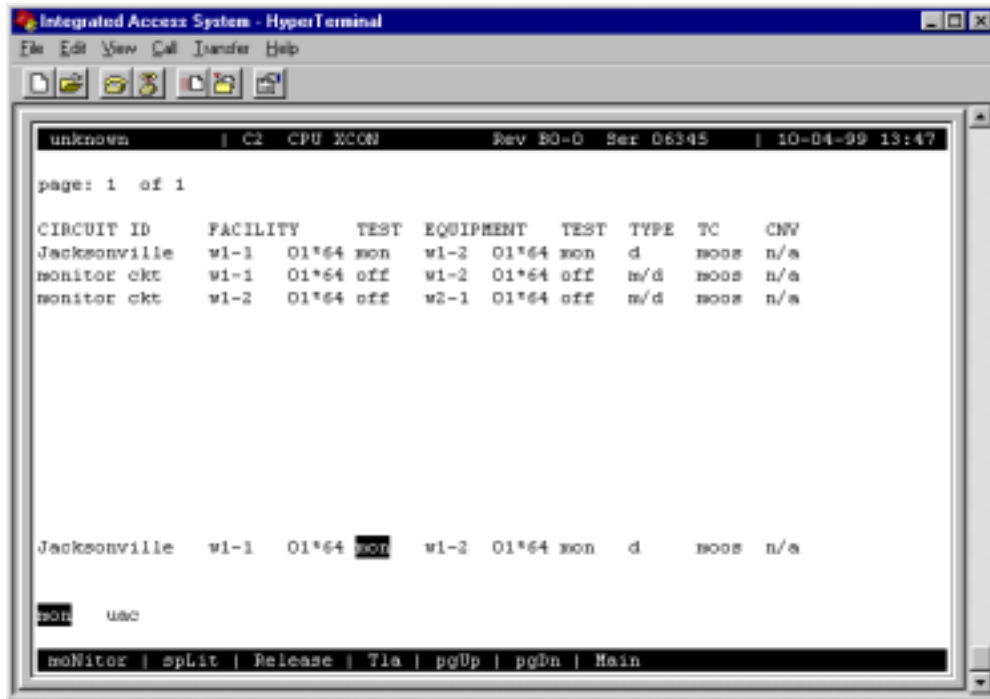

Figure 4-59. TLA Circuit State Screen

Table 4-8. TLA Circuit State Screen Menu of Actions

Action	Function
moNitor	The Monitor command allows the user to create a monitor circuit at the WAN interface. See section above.
spLit	The Monitor command allows the user to create a split circuit at the WAN interface. See section above.
Release	The Release command allows the user to release and restore a split circuit or a monitor circuit. See section above.
Tla	The Terminate and Leave Access (TLA) command is the capability to terminate one or both directions of transmission on a circuit. See section above.
pgUp	The pgUp (Page Up) action is initiated by pressing the "u" key. Since the system can handle many different TADS circuits, you may fill the screen allotment for data. New pages will be added automatically to accommodate additional circuits. Use this command to scroll up through the pages of TADS information.
pgDn	The pgDn (Page Down) action is initiated by pressing the "d" key. This action is similar to the pgUp command. Use this command to scroll down through the pages of cross-connect information.
Main	Pressing "m" (Main) will return you to the cross-connect screen.

4.22 Checking the Time Slot Map

Once you select and assign the time slots, you can view the list of DS0 connections (the time slot map) through the WAN card Cross-Connect Screen for cross-connect systems. You can see the results of your assignments in the time slot map as follows:

1. From the Main Screen, select the WAN card in slot W-1.
2. Type “x” (**Xcon**) to bring up the time slot screen (see Figure 4-60 for T1 operation and Figure 4-61 for E1 operation).
3. Selecting “m” (**Main**) to return users to the WAN card Main Screen.
4. Selecting “m” (**Main**) again will return users to the Main System Screen.

TS	XCON	TS	CIRCUIT_ID	TS	XCON	TS	CIRCUIT_ID
0	frame align		64k	16	cas		64k
1	u2-1	D-03	user_circuit	17	u3-4	A-04	user_circuit
2	u2-1	D-04	user_circuit	18	u3-5	A-05	user_circuit
3	u2-1	D-05	user_circuit	19	u3-6	A-06	user_circuit
4	u2-1	D-00	user_circuit	20	u3-7	A-07	user_circuit
5	u2-1	D-01	user_circuit	21	u3-8	A-08	user_circuit
6	u2-1	D-02	user_circuit	22	u1-1	A-09	user_circuit
7	u2-2	D-09	user_circuit	23	u1-2	A-10	user_circuit
8	u2-2	D-10	user_circuit	24	u1-3	A-11	user_circuit
9	u2-2	D-11	user_circuit	25	u1-4	A-12	user_circuit
10	u2-2	D-06	user_circuit	26	u1-5	A-13	user_circuit
11	u2-2	D-07	user_circuit	27	u1-6	A-14	user_circuit
12	u2-2	D-08	user_circuit	28	u1-7	A-15	user_circuit
13	u3-1	A-01	user_circuit	29	u1-8	A-17	user_circuit
14	u3-2	A-02	user_circuit	30			
15	u3-3	A-03	user_circuit	31			

Figure 4-60. Typical Time Slot Screen for T1 Operation

For E1 transmission (Figure 4-61), time slot 0 and 16 are not available for assignment on either the HSU table or the voice card time slots. Like T1 operation in **d/i** mode, unspecified time slots are **automatically** assigned to corresponding slots on the other WAN port on the same card.

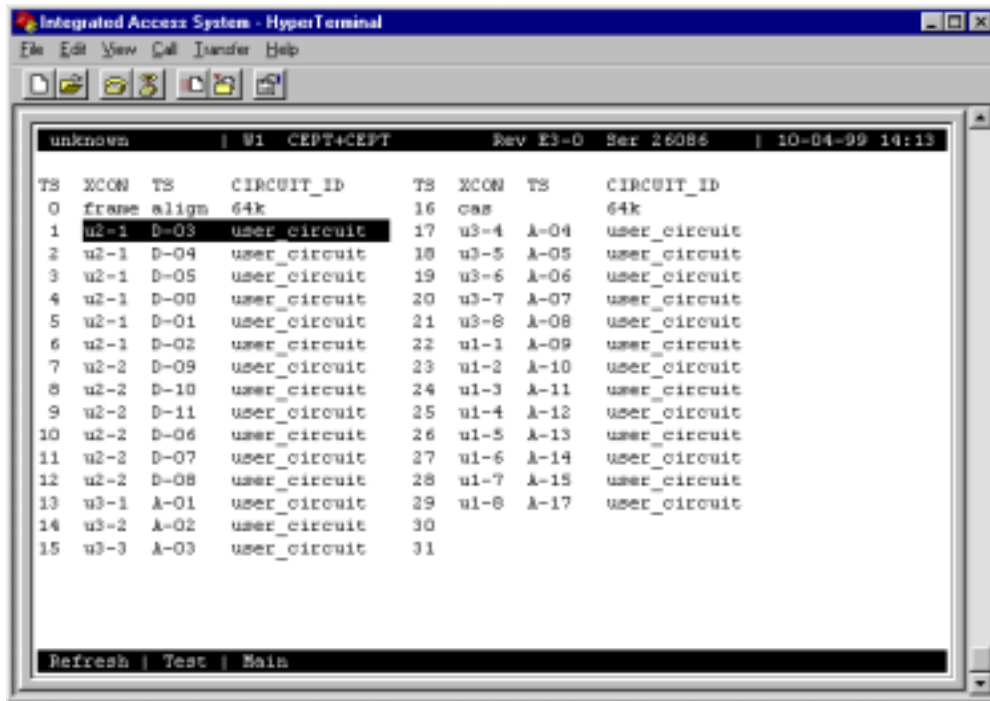

Figure 4-61. Typical Time Slot Screen in E1 Operation

4.23 Recording the Time Slot Configuration

After setting up the initial system configuration and define the time slot map, record this information on paper. Recording the initial configuration in a logical manner will help if you have a problem later.

Record the information in a way that makes sense to you and will be easy for others to understand. Also be sure to note the initial settings for each card in copies of the T1 or E1 operation tables provided in Table 4-9 and Table 4-10. Store all initial configuration information in a safe place where anyone needing to service the system can easily find it.

Table 4-9. Time Slot Recording Form for T1 Operation

WAN Port No. _____ - _____

TS Number	Card Type	Port Number
1		
2		
3		
4		
5		

System Configuration and Operation Recording the Time Slot Configuration

6		
7		
8		
9		
10		
11		
12		
13		
14		
15		
16		
17		
18		
19		
20		
21		
22		
23		
24		

Table 4-10. Time Slot Recording Form for E1 Operation

WAN Port No. _____ - _____

TS Number	Card Type	Port Number
0		
1		
2		
3		
4		
5		
6		
7		
8		
9		
10		
11		
12		
13		
14		
15		
16		
17		
18		
19		
20		
21		
22		
23		
24		
25		

26		
27		
28		
29		
30		
31		

4.24 Redundant Operations

This section describes the redundancy features of the Integrated Access System, and provides instructions for configuring the system with redundant elements.

The Integrated Access System can be configured with redundant (backup) critical system elements. This feature switches operation from failed components to identical backup replacements, thereby reducing the likelihood of service disruptions.

The four areas of redundant operation are the power system, the CPU card, WAN card, and ADPCM cards. These are described below.

4.25 Power Supply Redundancy

Each power supply component is designed to switch to a backup if a primary unit fails. Also, the defective unit will create a system alarm upon failure, to alert an operator so that the necessary diagnostic and repair work can be initiated. The following power supply components can have redundancy:

- AC Power Supply
- DC Power Supply
- AC/DC Converter
- Ringing generator (master only; see below)

Upon failure, the LED on the AC-DC power converter will be turned off but **will not generate a system alarm** (unless the system is equipped with the ALR 4+3PF Card (External Alarm card)).

If the primary ringing generator fails, an alarm will be generated and the LED will turn off. If a backup ringing generator fails, the LED will turn off but no alarm will be generated by the system.

Figure 4-62 shows a System Main Screen with redundant power supplies, in which Power Supply 1 (PS1) has failed. The power supply failure is noted in the alarm message **PS1 OOS** in the upper right corner of the screen.

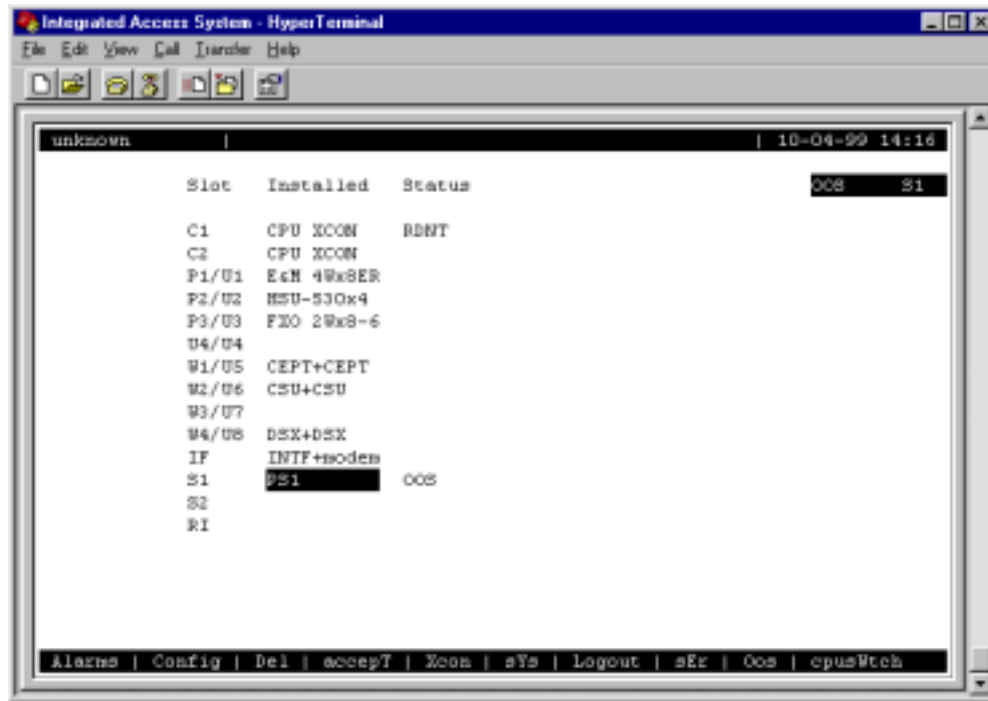

Figure 4-62. Typical Redundant-Power Supply System Main Screen

4.26 CPU Card Redundancy

CPU card redundancy is valuable because the CPU card is essential to system operation. CPU redundancy is supported using two CPU-5 XCON (880360). The CPU card in slot C2 will be the redundant card for the CPU XCON card in slot C1, but only if they are both the same type with the same level of Host Code, for example 5.1.x. For redundancy, the first two digits of the Host Code must be the same, but the last digit does not matter.

A switch from one CPU card to the other is triggered by any of the following:

- A software command issued by an operator
- Removal of the active CPU card from the system
- Failure or malfunction of the active CPU card

During a CPU redundancy switch over, disruptions to voice and data traffic are momentary and traffic will recover automatically.

Figure 4-63 shows a System Main Screen with redundant CPU cards. The card in slot C1 is active, and the card in slot C2 is redundant. To switch operation to the redundant CPU card, press “w” to invoke the **cpusWtch** command from the bottom highlighted line of this screen. The system prompts you with a yes/no confirmation prompt, as shown.



Figure 4-63. Manually Switching to a Redundant CPU

At the prompt, press “y”. The CPU card in slot C2 is now active, and the CPU card in C1 is redundant (**RDNT** status), as shown in Figure 4-64. These states remain in effect on both cards until you manually switch back to the CPU card in slot C1.

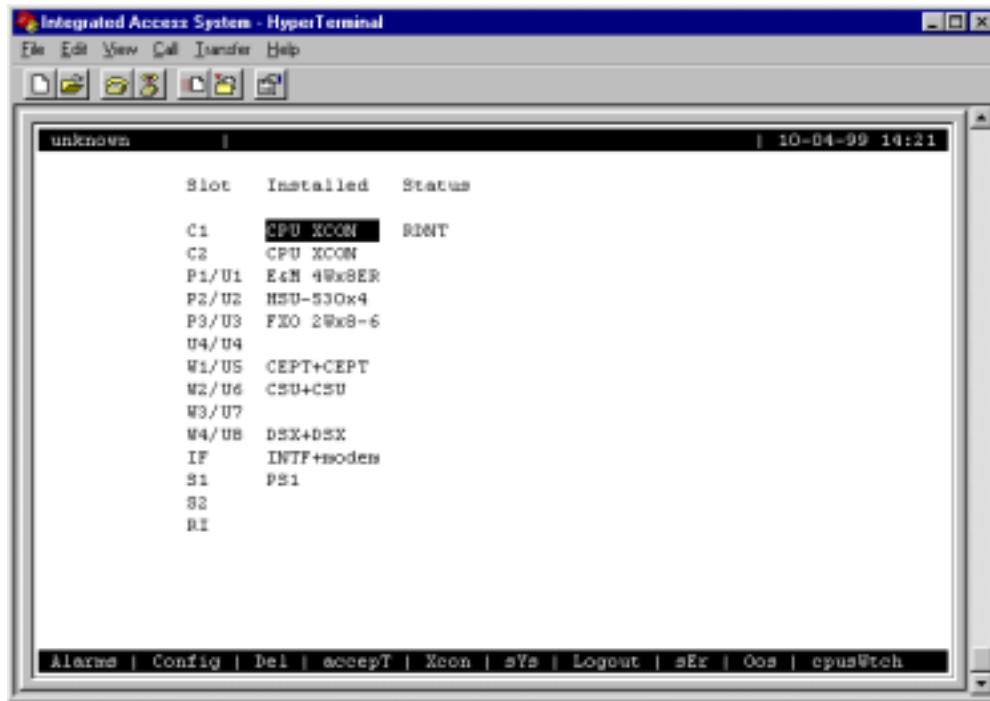

Figure 4-64. Typical System with CPU Switchover Completed

4.27 WAN Card Redundancy

Both T1 and E1 WAN redundancy are supported in cross-connect systems.

The cross-connect system allows 1:N redundancy with an 801460 WAN in slot W4 protecting the 801060 WANs in slot W1 through W3. Only WAN cards with identical DSX, CEPT and/or CSU modules and configured the same are protected. The 801460 1:N redundancy protects against WAN card failure only, it does not protect against T1/E1 facility failure. The 801460 WAN card in slot W4 must not have any T1/E1 connections as it will disturb the signal and cause a constant CGA alarm to be logged.

WAN redundancy switching can be initiated by one of the following:

- A software command issued by the operator
- Removal of the active WAN card from the system
- Failure of the active WAN port or card
- CGA alarm declaration on the active WAN port or card

During a WAN redundancy switch, voice and data traffic are momentarily disrupted, and transmission then recovers automatically.

4.27.1 Cross-Connect WAN Card Redundancy Switching

In cross-connect systems, WAN redundancy requires a WAN-R DUAL card in slot W4 (as marked on its faceplate ejector). This card becomes a redundant card for the WAN cards in slots W1 through W3 if it is equipped with matching DSX/CEPT, CSU, or HDSL modules, and if those modules are installed in the same positions on both WAN cards. This protection scheme is known as 1-in-N redundancy. When a switch occurs, a relay on the WAN-R card switches the output of that card to the corresponding pins on the WAN connector of the Interface card.

The following restrictions apply to cross-connect WAN redundancy:

You must install the WAN-R card in slot W4 for redundancy. If you install it in slot W1, W2 or W3, it will work only as a standard WAN card with two ports.

If the plug-in modules on the WAN-R card do not match those on a card in slot W1, W2, or W3, the WAN-R card will not behave as a backup for that active WAN card. The system will not reject the card, but it will not switch even if the active WAN card fails.

If a standard WAN card is in slot W4, the system does not support WAN redundancy.

In cross-connect systems, switching always occurs on both ports of a WAN card. Therefore, both ports of all active WAN cards must have the same plug-in modules as the redundant-card ports.

Figure 4-65 shows a System Main Screen for a cross-connect system with WAN card redundancy. In this example, the CSU ports of the WAN cards in slots W1, W2, and W3 are backed up by the CSU ports of the WAN card in slot W4. The redundant WAN card in slot W4 takes over for the first active WAN card that fails.

The screenshot shows a HyperTerminal window titled "Integrated Access System - HyperTerminal". The window displays a table with three columns: "Slot", "Installed", and "Status". The table lists various hardware components and their current status. At the bottom of the window, there is a command prompt with several menu options.

Slot	Installed	Status
C1	CPU XCON	RDNT
C2	CPU XCON	aaaa
P1/U1	EcM 40x8ER	aaaaaaaa
P2/U2	NSU-530x4	aaaa
P3/U3	FXO 20x8-6	aaaaaaaa
U4/U4	BRI-Ux8ac	aaaaaa #
W1/U5	DSX+DSX	aa
W2/U6	DSX+DSX	aa
W3/U7	DSX+DSX	aa
W4/U8	DSX+DSX	rr
IF	INTF+modem	
S1	PS1	
S2		
RI		

At the bottom of the window, the command prompt shows: `Alarms | Config | Del | accepT | Xcon | sYs | Logout | sEr | Oos | cpusWtch`

Figure 4-65. Typical Cross-Connect System with WAN Card Redundancy

Figure 4-66 shows a WAN Card Main Screen for the card in slot W1 with port 1-1 selected. To force a switch, press "w" (**sWitch** command), then press "y" to complete the switch. The traffic on the WAN card in slot W1 will be switched to the WAN-R card in slot W4. The Main System Screen (see Figure 4-66) now shows both ports of the card in slot W4 as active port (Status = **aa**) and the ports on the card in slot W1 as redundant (Status = **rr**).



Figure 4-66. Switching to a Redundant Cross-Connect WAN Card

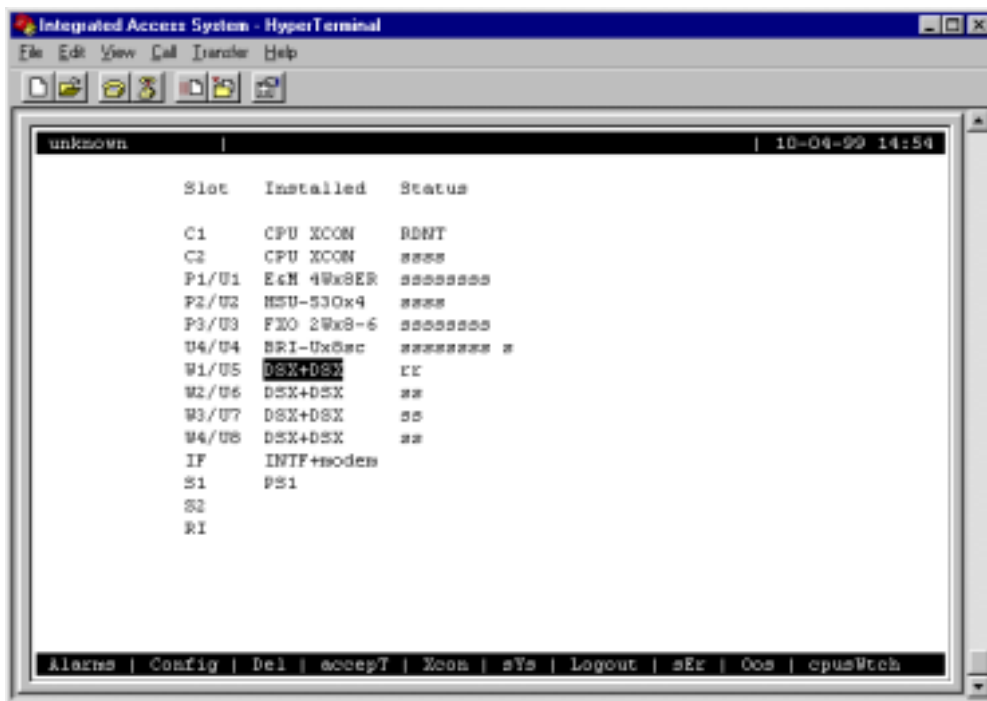

Figure 4-67. Typical Cross-Connect WAN Card Redundancy Switch in Progress

4.28 ADPCM Card Redundancy

The Integrated Access System can also have ADPCM cards, which use voice compression technology to effectively increase the digital voice transmission capabilities of voice cards (E&M, FXS, or FXO) or WAN links. See Server Card Reference Guide for more information on the ADPCM card.

Each system can have up to three ADPCM cards in slots P1 through P3, depending on slot availability. In systems with two or three ADPCM cards, any of those cards can be selected as the redundant (backup) card. There are no restrictions on chassis slot order.

Figure 4-68 shows a system with three ADPCM cards. The ADPCM card in slot P1 is highlighted. Pressing <Enter> will bring up the ADPCM Main Screen shown in Figure 4-69.

Slot	Installed	Status
C1	CPU XCON	RMNT
C2	CPU XCON	xxxx
P1/U1	ADPCM-64x1	xxxxxxxx
P2/U2	ADPCM-64x1	xxxxxxxx
P3/U3	ADPCM-64x1	xxxxxxxx
U4/U4	BRI-Ux8ac	xxxxxxxx x
W1/U5	E&M 4Wx8ER	xxxxxxxx
W2/U6	MSU-530x4	xxxx
W3/U7	DSX+DSX	xx
W4/U8	DSX+DSX	xx
IF	INTF+modem	
S1	PS1	
S2		
RI		

unknown | 10-04-99 15:01

Alarms | Config | Del | accepT | Xcon | sYa | Logout | sEr | Oos | cpus@tch

Figure 4-68. Typical System with Redundant ADPCM Cards

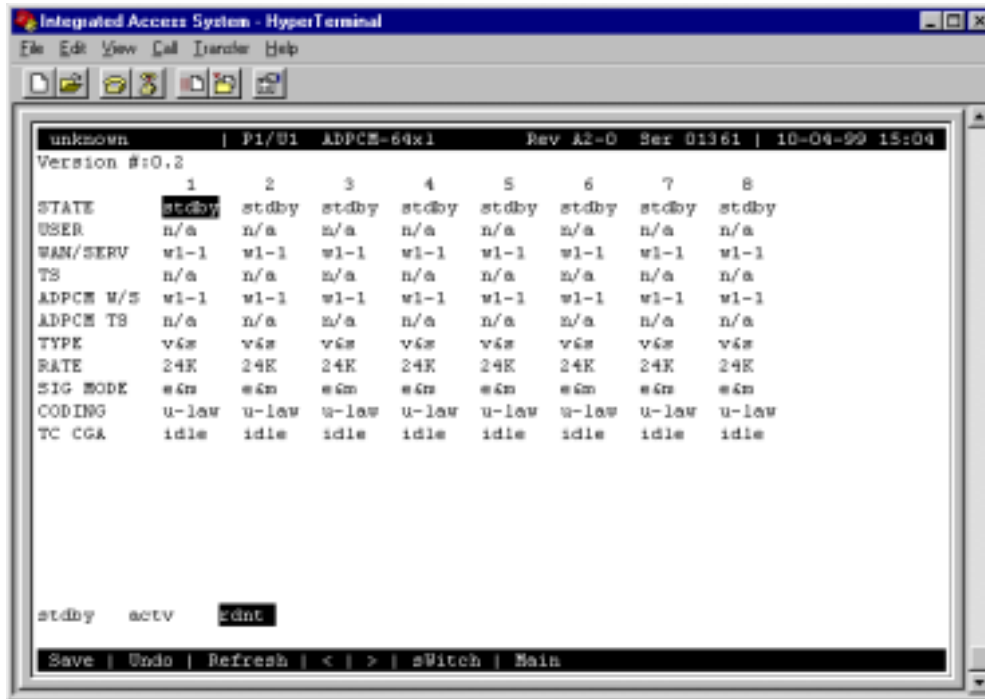

Figure 4-69. Typical ADPCM Card Main Screen

To choose a redundant ADPCM card for the system, proceed as follows:

1. Go to the System Main Screen (if you are not already there).
2. Select the desired ADPCM card from the System Main Screen, and press <Enter> to go to the Main Screen of that card. Figure 4-69 shows the card in slot P1 is chosen.
3. Highlight the STATE parameter of any ADPCM port on the card, and press the <Enter> key. This changes the STATE setting to **rdnt**. The entire ADPCM card now becomes the redundant ADPCM card for the system.

The System Main Screen now looks like Figure 4-70. The status of all ADPCM ports of the card in slot P1 is “r”.

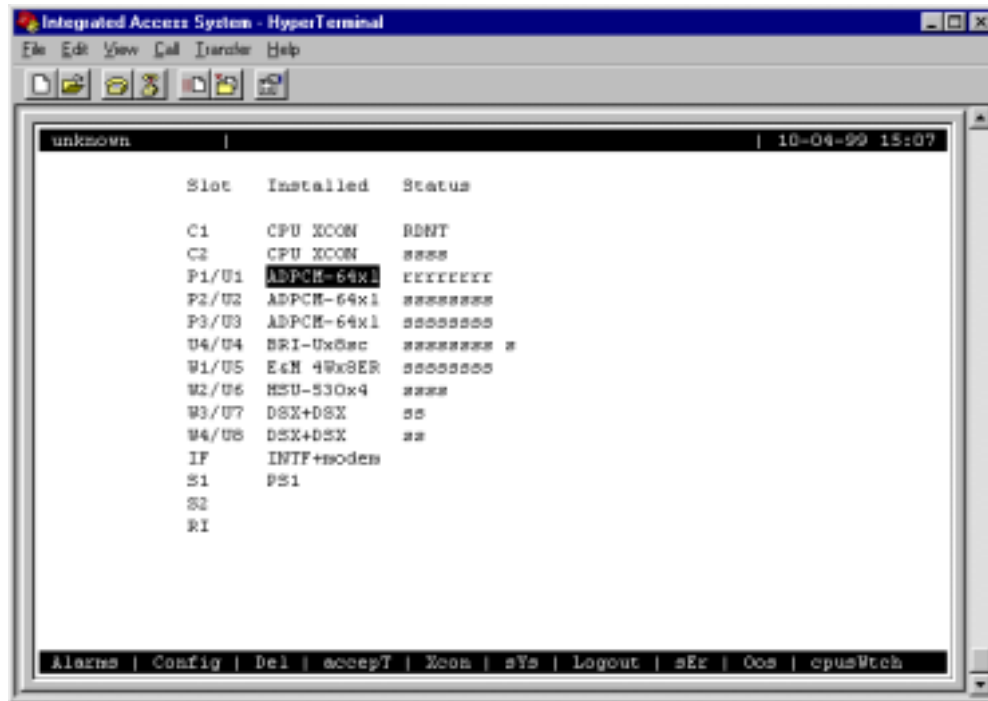

Figure 4-70. Typical ADPCM Card Redundancy Switch in Progress

If the card in slot P2 or P3 fails, the entire voice compression network will switch to the redundant card in slot P1. When the Out of Service condition is repaired, the ADPCM card in the slot that previously failed becomes the redundant card for the system.

The system does not require any ADPCM cards to be redundant. All three slots (P1 to P3) can be used for normal traffic on ADPCM voice networks.

Chapter 5

CPU Card

5.1 Introduction

The CPU is the “brain” of the Integrated Access System and performs most of the configuration, management, and common processing for the system. In addition the CPU card provides the interconnection of WAN/User/Server Pulse Code Modulation (PCM) buses through a bus connect or cross connect function. The Integrated Access System can have up to 2 CPU cards which provide a redundant control and switching complex. If the primary CPU fails, the standby takes over. A Mini-DACS 1/0 cross-connect for 256 DS0s is available.

5.2 CPU Card Descriptions

5.2.1 CPU XCON (880360)

The CPU XCON card controls the Integrated Access System. It performs the following functions:

- Initializes the system upon power-up, and runs a self-test on all cards plugged into the chassis at that time.
- Polls all cards in the system every second to determine their operating status.
- Processes all incoming operator commands and displays the responses in a series of operator interface screens for each card in the system. The operator interface system (local VT-100 terminal, remote computer, or network management system) connects to the Interface card, which sends these commands to the CPU card for processing.
- Includes circuitry that allows you to cross-connect DS0 time slots between T1 and E1 lines connected to the system WAN cards. Refer to the DS0 time slot assignment operations.
- Includes a test pattern generator for T1 and E1 line test purposes.
- Performs primary-secondary CPU arbitration. In a system with redundant CPU cards, the two CPU cards communicate their status to each other. If the primary CPU card fails, the redundant card takes over and becomes the primary.

5.2.1.1 Card Jumper/Switch Settings

The CPU XCON Card has US/EURO jumpers on its motherboard.

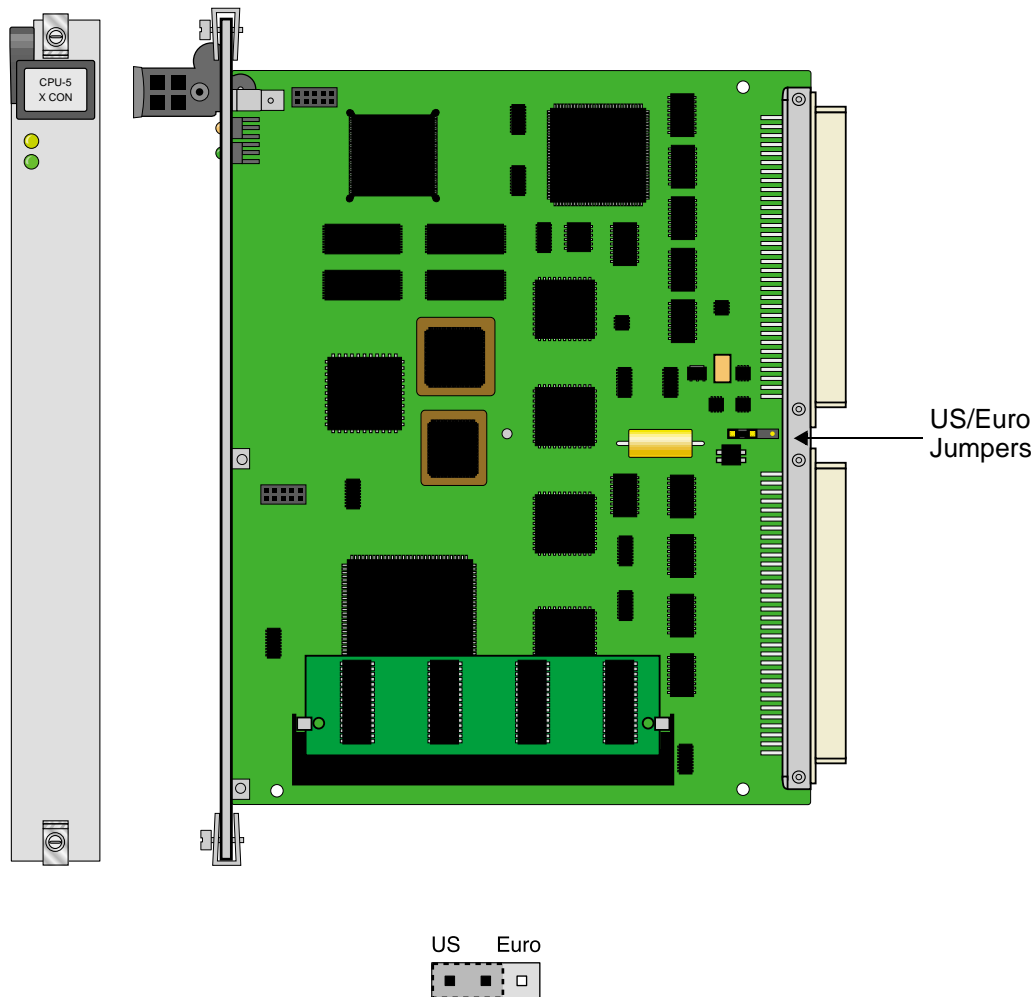

Figure 5-1. CPU XCON US/EURO Jumper Settings

5.2.1.2 Installing the CPU XCON Card

Install the CPU XCON card into slot C1 of the system chassis. If your system will use redundant CPU cards, also install another identical card into slot C2. The card in slot C1 will be the primary, and the card in slot C2 will be the secondary.

5.3 CPU Card User Screens and Settings

The CPU card has several user interface screens for card configuration and network status viewing purposes. These screens are described in the remainder of this chapter.

5.3.1 CPU Card Main Screen

Figure 5-2 shows the CPU Card Main Screen. You must configure the CPU card after logging into the system for the first time. To view this screen, highlight the desired CPU card in the System Main Screen and press <Enter>.

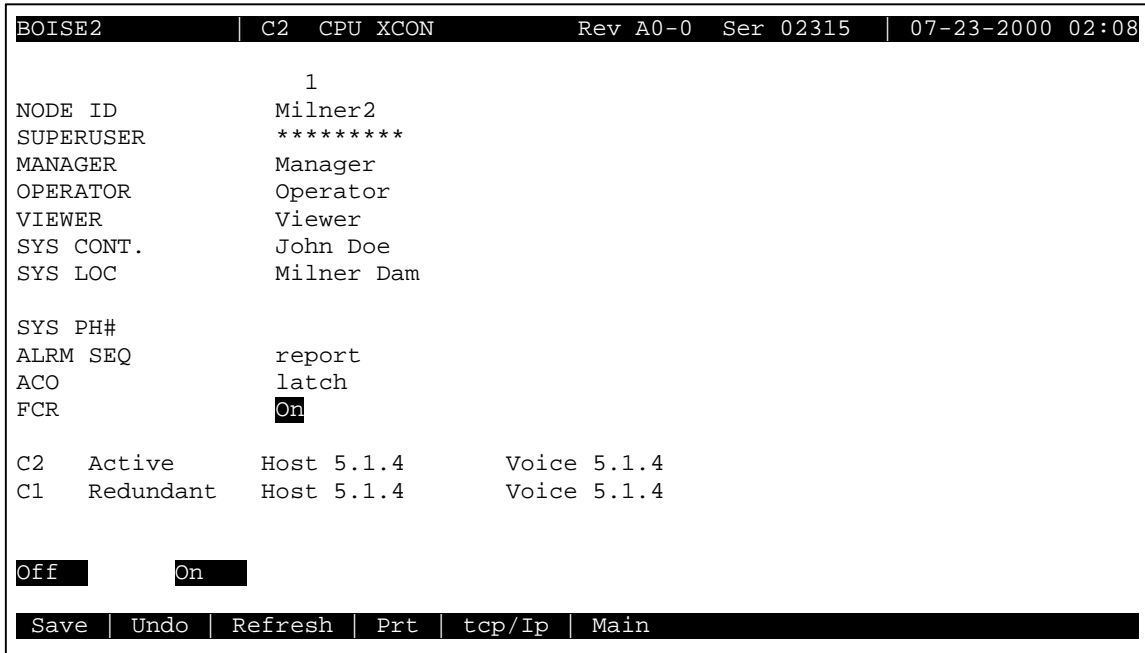

Figure 5-2. CPU Card Main Screen

The CPU card has numerous settings that you must configure. The CPU Main Screen displays the status of each CPU card (active or redundant), the type of card installed, and the host and voice software versions currently installed on that card. The settings are described in the next few sections of this chapter.

The bottom highlighted line of the above screen shows a series of actions you can perform in this menu. To perform an action, press the letter key associated with the uppercase letter of the desired action. For example, to save your card option settings after making them, press “s” to invoke the **Save** command. Table 5-1 lists and describes these actions.

Table 5-1. CPU Card Main Screen Actions

Action	Function
Save	Saves changes to settings.
Undo	Returns all settings to the last saved state.
Refresh	Updates certain time-related information fields that are not automatically updated (i.e., performance and test data).

Prt	Allows the user to print alarms to a remote device through the modem and/or the DB-9 computer port on the Interface Card. Refer to the "Printing Alarms Remotely" section later in this chapter.
tcp/Ip	Allows the user to configure for TCP/IP functionality.
Main	Returns you to the System Main Screen. If you made changes to any card settings but did not save them yet, you will be prompted to save or lose those changes before exiting.

5.3.1.1 Changing Your Passwords

You may want to change your system access passwords frequently, in order to maintain optimum security on your network. The recommended passwords are a minimum of 6 and no more than 12 characters in length, are not found in a dictionary, and contain both letters and numbers. Because the system is case-sensitive for password entries, you can mix uppercase and lowercase letters to provide more possible passwords.

The system provides three passwords that can be edited. Each represents a different access level that allows an operator to perform system certain tasks after logging in.

To change a password, first log into the system under the **Manager** access level password, then choose the CPU card from the System Main Screen. Then, in the CPU Card Main Screen (Figure 5-2), highlight the password you want to change, press the <Enter> key, type the new password over the current one, and press <Enter> again. Finally, make sure the new password appears as you want (remember that passwords are case-sensitive), and save your changes.

SUPERUSER

The "*Superuser*" password level is reserved for use only by factory personnel. You cannot edit this password.

MANAGER, OPERATOR, AND VIEWER

The other three passwords are, "*Manager*," "*Operator*" and "*Viewer*." Each of these passwords can have up to 14 characters (letters and numbers only). All three passwords are case-sensitive.

5.3.1.2 Other CPU Card Settings

You also must set the additional card parameters described below in the CPU Card Main Screen. Most of these are user-defined alphanumeric entries. To make new entries in these fields, first press <Enter> to highlight the current entry in the lower left of the screen. Then, type the new data on the keyboard. If you make a mistake, press either the backspace or <Delete> key to back up the cursor and erase the incorrect characters. Then, retype the correct characters. Finally, press <Enter> again to store the new entry in the field.

NODE ID

In this field, enter a 14-character node name for the Integrated Access System. This entry must be unique for each system in your network. It can have alphanumeric characters and spaces.

SYS CONT

In this field, enter the name of a person to contact for questions about the Integrated Access System. This field can have up to 23 alphanumeric characters, including spaces. For convenience, use the system administrator's name in this field.

SYS LOC

In this field, specify the location of the Integrated Access System. This field can have up to 23 alphanumeric characters, including spaces.

SYS PH#

Type the phone number of the Integrated Access System in this field. This phone number is used by a remote operator to access the system for a VT-100 session, via either ISDN D-channel dialing or a Remote IMACS Terminal System (RITS). You can enter up to 10 numeric characters in this field. However, do not include any dashes in this entry.

ALRM SEQ

The Alarm Sequence setting establishes how the sequence number for alarms is generated. Set this option to **all** if you want any alarm generated by the system to be assigned a sequence number. Or, set this field to **report** if you want only the alarms set to **report** to have sequence numbers.

ACO

The Alarm Cutoff (ACO) option reports a status to you based on the **latch** (condition held) or **cur** (current condition) setting.

FCR

FCR will allow traffic circuits to resume their activity after a T1 line failure faster than what is implemented in the Integrated Access System prior to this release. This feature may have applications in 'protective relaying circuits', assuming that random data received during the period of the outage is acceptable

With FCR Off - Default

Integrated Access System operation follows the standard requirements of service restoration for failures. If a T1 line or WAN card fails, the system will generate either a red or yellow alarm and will clear CGA-RED and CGA-YEL alarms per standard definitions.

FCR On

With FCR On the Integrated Access System will bypass the standard equipment. The system will clear CGA-RED and CGA-YEL alarms immediately after a T1 frame is recovered. This will allow restoration of the voice and data circuits within 700 400ms.

5.3.2 Printing Alarms Remotely

Integrated Access Systems are typically placed in unattended locations (equipment closets, etc.). If no one is present to detect alarms that might occur, a system administrator has no way of knowing whether or not the system is working properly.

The solution to this network management problem is the Print Alarm feature. Each system unit can be programmed to call a predetermined telephone number at specific intervals and report the presence of selected system alarms. Choose alarms to print remotely by selecting the **Report** option in the alarm filters.

You can use either an external modem or the internal modem (2.4 kbps) on many of the Interface cards to send system alarms to a remote logging device, such as a printer or personal computer. If using the internal modem, the remote device should be connected to a V.22bis 2.4 kbps asynchronous modem set to auto-answer mode, eight data bits, one stop bit, and no parity. When the modem connected to the remote logging device answers, the system sends the alarm messages as a string of ASCII characters formatted with carriage returns and line feeds, then terminates the call. More information on this process can be found later in this chapter.

A network administrator can also call the phone number associated with the system modem and initiate a two-way, interactive VT-100 session with the system to determine the nature of the problem and dispatch technicians if necessary.

Another Network Management solution is the TCP/IP feature discussed later in this chapter. Note that **if the TCP/IP network management system is active, the Print Alarm feature will not operate.**

Using the TCP/IP feature automatically converts alarm messages into SNMP traps for forwarding to downstream NMS equipment.

To get to the CPU Print Alarm screen in Figure 5-3, press “**p**” to choose the **Prt** command from the CPU Card Main Screen.



Figure 5-3. Typical CPU Print Alarm Screen

Table 5-2 lists the operations that can be performed from the Print Alarm Screen above. These appear on the highlighted line at the bottom of the screen.

Table 5-2. Print Alarm Screen Actions

Action	Function
Save	Saves changes to settings.
Undo	Returns all settings to the last saved state.
Refresh	Used on Monitoring Screens to update statistics, and on other screens to redraw them.
Main	Returns to the CPU Card Main Screen. If changes are made to settings and not saved, you will be prompted to save or lose changes.

Table 5-3 summarizes the option settings for the CPU Print Alarm Screen. These settings are also described in the following paragraphs.

Table 5-3. Print Alarm Screen Options and Defaults

Parameter	User Options	Notes	Default
PRT ALARMS	off direct modem	1	off
PRT Phone#	telephone number (up to 14 numbers)		
PRT RETRY	1 to 60		1

PRT ATTEMPTS	1 to 99		1
PRT MAJ&CRIT	1 to 500		1
PRT MIN&INFO	1 to 32000		1
ELEMENT 1	alarm number	model empty	address time severity 2
ELEMENT 2	alarm number	model empty	address time severity 2
ELEMENT 3	alarm number	model empty	address time severity 2
ELEMENT 4	alarm number	model empty	address time severity 2
ELEMENT 5	alarm number	model empty	address time severity 2
ELEMENT 6	alarm number	model empty	address time severity 2

Notes:

1. The Print Alarms option must be **off** if TCP/IP is **on**.
2. The choice of “empty” will eliminate that element from the NMS report.

PRT ALARMS

The Print Alarms option allows you to choose a remote device for alarm condition reporting. The system uses the modem (if present) on the Interface card to call a remote device or Network Management System. The system sends the alarm information for all alarm filters set to **Report** in the Alarm Filters screen. Refer to Chapter 4 *System Configuration and Operation*.

Set the Print Alarms setting to **off** to disable all external alarm-generated messages. Choose **direct** to send all alarms reported since the last report cycle to a local device through the DB-9 computer port of the Interface card. The **modem** setting sends all alarms reported since the last report cycle to a remote dial-up device through the modem port.

The remote device may be any asynchronous ASCII device that can accept lines of text up to 80 characters long. It must support XON/XOFF flow control and be capable of attaching to an asynchronous dial-up modem. Figure 5-4 shows an OOS alarm reported to a remote device.

The remote device’s modem must be compatible with CCITT V.22bis and support connections at 2.4 kbps. Set the remote modem for auto-answer mode. **Both the remote device and modem should be set for 8 data bits, 1 stop bit and no parity.**

PRT PHONE#

The Print Phone Number field shows the number the modem dials to report alarms to the remote device. This number can be up to 14 digits long.

PRT RETRY

The Print Retry field specifies the amount of time the system will wait between attempts to redial the remote device. The retry interval can be from **1** to **60** minutes.

PRT ATTEMPTS

The Print Attempts field is the maximum number of times the system will try to contact the remote device before giving up. The number of attempts can be from **1** to **99**.

PRT, MAJ&CRIT

The Print Major field specifies the maximum amount of time the system will wait from the occurrence of a major alarm until it places a call to the external device to report it. This interval cycle can be from **1** to **500** seconds. All alarm reports designated as **Major** will be reported at that time. For example, if you specify an interval cycle of 5 minutes (300 seconds), every major alarm occurring during that interval will be reported at the end of that cycle.

The Print Major and Critical interval cycle starts from the most recent of:

1. The end of the last Major alarm cycle (if no alarms occur).
2. When parameters are saved using the Save command from the Menu of Actions.
3. Forty (40) seconds after the last alarm message is reported.

PRT MIN&INFO

The Print Minor field is the maximum time the system will wait from the occurrence of a minor alarm until it places a call to the remote device to report it. This interval cycle can be from **1** to **32,000** seconds. All alarm reports designated as **Minor** will be reported at that time. For example, if you specify an interval cycle of 60 minutes (3600 seconds), every minor alarm that occurs during that interval will be reported at the end of that cycle.

The Print Minor interval cycle starts from the most recent of any of the following:

1. The end of the last Minor alarm cycle (if no alarms occur).
2. When parameters are saved via the **Save** command from the Menu of Actions.
3. Forty (40) seconds after the last alarm message is reported.

When the specified interval cycle for major or minor alarms is reached, the system will send a list of the accumulated alarms sorted by the elements below. To avoid congestion, alarm reporting is limited at the remote device or Network Management System to the first 40 lines of non-reported alarms. The system will then wait 40 seconds and send the next 40 lines, and

continue sending in that fashion (i.e., send 40 lines, wait 40 seconds) until it finishes the entire list of non-reported alarms. The next interval cycle starts 40 seconds after the last alarm message is reported.

ELEMENT 1-6

The Element 1 through Element 6 fields show the six alarm configuration elements (**alarm, model, address, time, severity, number, and empty**). These elements can be arranged in any user-defined order. For instance, one user may want the order of the alarm configuration to be severity, time, model, address, alarm, and number, while another user might prefer the sequence to be model, time, alarm, address severity, and number. Use the six Element fields to order these variables as desired.

Figure 5-4 shows a typical remote printout of alarms reported by an Integrated Access System. In this example, the Node Name (NO) is "Node_1," the Acknowledgment Number (AK) is 7, the Alarm Number (NU) is 38. This is an Out of Service alarm (AL = OOS); it was reported by a Model (ML) 8840 Card in chassis slot P2 (UN = P2). The alarm began on 3/20/96 at 14:44:12 (2:44 p.m.) and ended on 3/20/96 at 16:12:16 (4:12 p.m.). The Severity level of this alarm is Critical (SV = C).

```
NO=Node_1, AK=7,  
NU=00038, AL=OOS, ML=8840, UN=P2, ON=03-20-96  
14:44:12,  
OF=03-20-96 16:12:16, SV=C  
END
```

Figure 5-4. Typical Alarm Printout

5.4 TCP/IP Network Management

This section presents another type of Network Management System (NMS) for diagnosing and reporting trouble at unsupervised locations. The SNMP alarm traps and TELNET configuration can connect using this alternate method. Both formats can use the 4 kbps FDL (Facility Data Link) of an ESF-framed T1 link, the SA4 on an E1 link, a full DS0 on a T1 or E1 link, or the computer port of the Interface card via SLIP or PPP protocol.

If you do not understand the NMS concepts of IP addressing, SNMP, SLIP or PPP, TELNET, and Ping, please consult with your network administrator before attempting to install or repair components presented in this section.

If you have a small number of remote units to manage, one of the Network Management System options is to use a B7R (Bit-7 Redundant) card at the NMS site. Up to eight remote system units send alarm information on the FDL/SA4 of a T1/E1 link to either a DACSII or

eight individual DS0s, and multiplex the contents into a single 38.4 kbps asynchronous circuit via the SLIP protocol. This data is used by a communication server or terminal server for routing to a Local Area Network.

If the FDL is used to transmit and receive information, a DACSII or DACSII ISX (3.0 or higher) is used to convert the FDL/IP information to a full DS0 time slot. On a point-to-point circuit, a DACSII is not needed. See Figure 5-5.

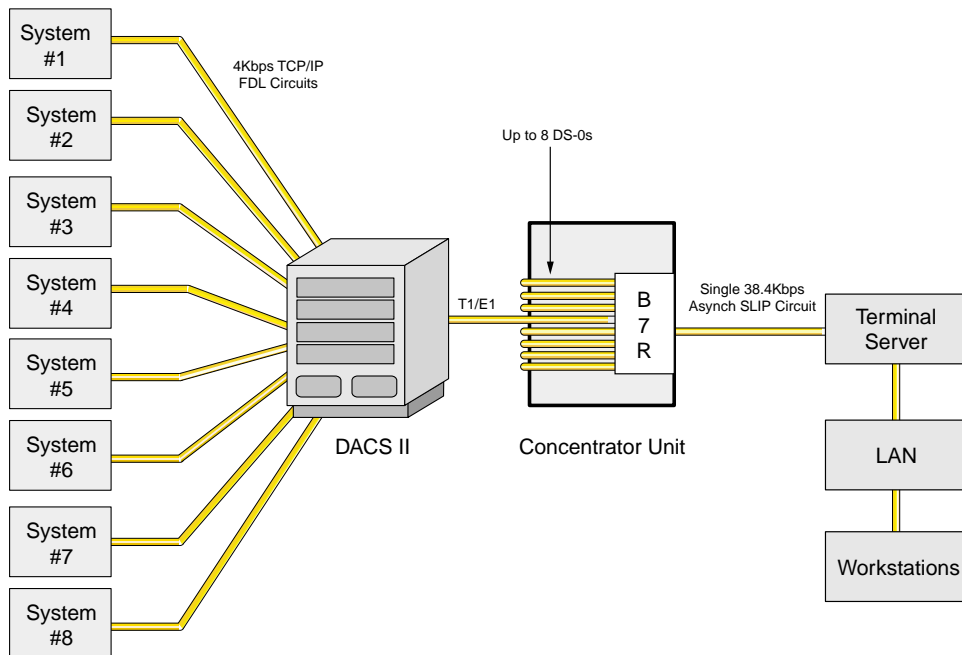

Figure 5-5. Typical TCP/IP Network Management System

Using IP addresses, you can communicate directly with the affected system, diagnose the problem, and dispatch a technician if necessary.

Figure 5-6 shows the TCP/IP Screen. To access this screen, press “**T**” (**tcp/Ip**) in the CPU Card Main Screen. Table 5-4 summarizes the actions that can be performed from this screen, and Table 5-5 lists the TCP/IP Screen parameters and options.

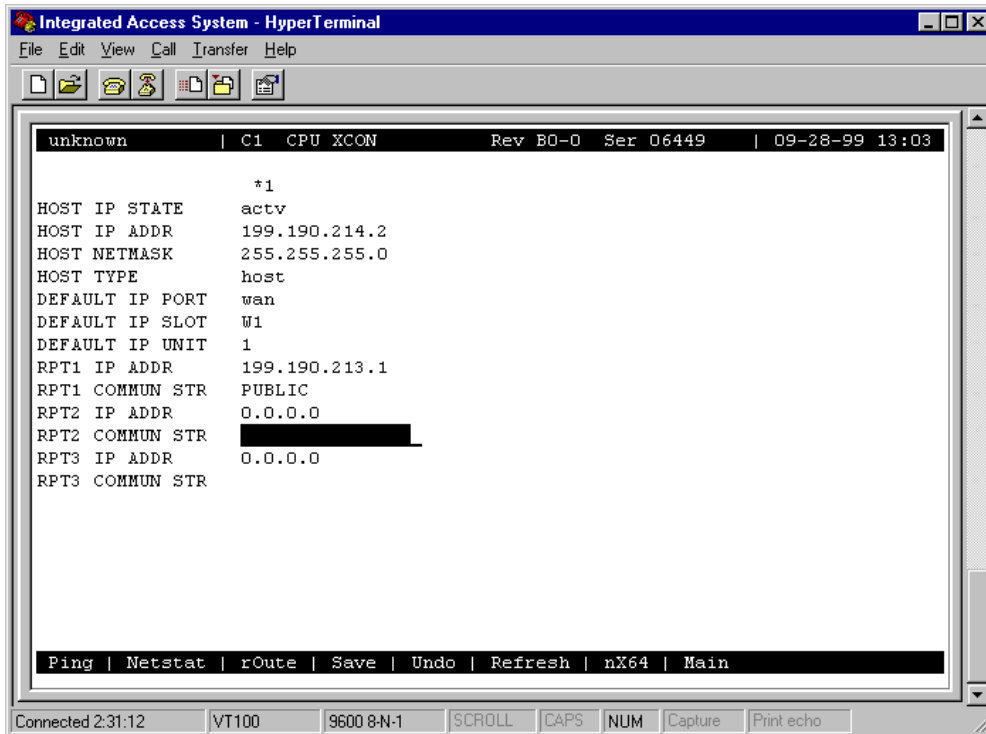

Figure 5-6. Typical TCP/IP Screen

Table 5-4. TCP/IP Screen Actions

Action	Function
Ping	Test whether the connected device responds to an echo request message. After entering the IP address of the host device, the status line will display, "Testing . . ." The next message indicates if the host is alive or down.
Netstat	Displays the Network Statistics. See below.
rOute	Shows the Routing screen. See the "Routing" section below.
Save	Saves changes to settings.
Undo	Returns all settings to the last saved state.
Refresh	Used on Testing and Monitoring screens to update statistics, and on other screens to redraw the screen.
nX64	Used for nx64 kbps HDLC/FR connectivity to other Integrated Access Systems as well as directly connecting to the MCC, IPR, FR at nx64 kbps.
Main	Returns to the CPU card main screen. If changes are made to settings and not saved, you will be prompted to save or lose changes.

Table 5-5. TCP/IP Screen Options and Defaults

Parameter	User Options	Default
HOST IP STATE	stdby actv	stdby

HOST IP ADDR	IP address	0.0.0.0
HOST NETMASK	Network	0.0.0.0
HOST TYPE	host gateway	host
DEFAULT IP PORT	none local wan servr nX64	none
DEFAULT IP SLOT	n/a local wan (w1, w2, w3, w4) servr (P1, P2, P3) nx64	n/a
DEFAULT IP UNIT	n/a 1-2 C1 C2 C3 C4	n/a
RPT1 IP ADDR	IP address	0.0.0.0
RPT1 COMMUN STR		blank
RPT2 IP ADDR	IP address	0.0.0.0
RPT2 COMMUN STR		blank
RPT3 IP ADDR	IP address	0.0.0.0
RPT3 COMMUN STR		blank

HOST IP STATE

This parameter determines whether TCP/IP is active or inactive. This is the master switch for the host IP stack, and is required to be set active in order for any IP communication to go through. The HOST IP STATE defaults to **stdby** (standby) prior to configuration. You must set it to **actv** (active) to enable TCP/IP.

HOST ID ADDR

The Host IP Address is the IP address for this specific system unit. If the B7R card is used for this NMS, the Port IP address must be the same as the one entered in the **ADDR** field of that card.

HOST NETMASK

The Host Netmask is used to indicate how much of the IP address is used for host addressing and how much is used for network addressing.

If the B7R card is used for this NMS, the CPU netmask address must be the same as the one entered in the **NETMASK** field of that card.

HOST TYPE

The Host Type is used to control IP forwarding. When Host Type is set to **gateway**, IP datagrams are allowed being forwarded. When Host Type is set to **host**, no forwarding is allowed. For IP forwarding (routing) to work correctly, a route must be created in the routing table.

DEFAULT IP PORT

The Default IP Port setting (Figure 5-7), tells the CPU card where IP packets will be sent when there is no matching entry in the routing table. The options are **none** (no default route used), **local** (SLIP/PPP over DB-9 serial port), **wan** (W1 W2 W3 W4) (FDL/SA4 or B7R [chosen on the WAN card main screen with ESF/NMS RPT option]) **servr** (P1 P2 P3) (WAN DS0s or Ethernet depending on type of server card) or **nX64** (C1, C2, C3, C4 WAN nx64 ports).

If this parameter is set to **local**, **wan** or **servr**, the Print Alarms feature (mentioned in the previous section) must be set to **off**. If **local** is chosen for this setting, the internal modem will not operate.

If this parameter is set to **nX64**, the default IP port selected is **nX64**, packets will be directed to one of the four nX64 ports selected (**C1**, **C2**, **C3** or **C4**). (Refer to Default IP Unit below).

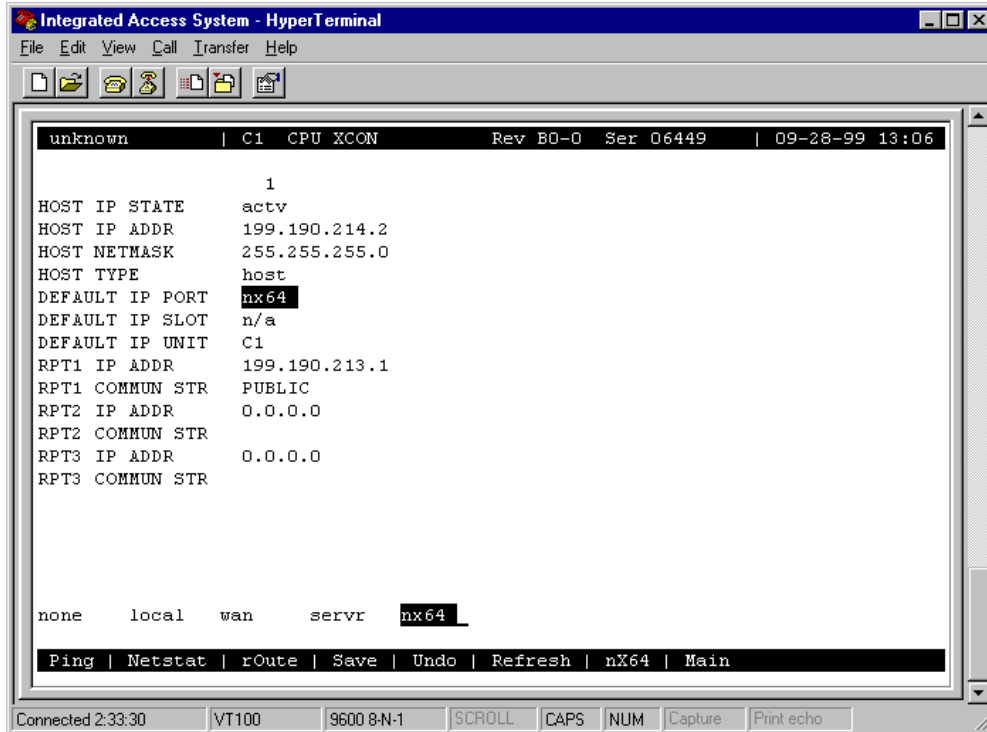

Figure 5-7. CPU Default IP Port Selection Screen

DEFAULT IP SLOT

The Default IP Slot options are determined by the choice of Default IP Port. If **off** or **local** is selected for that parameter, this option will show **n/a**. If **wan** is selected, the options for this parameter will show **W1-W4** (the WAN card slot that transmits and receives NMS information). If **servr** is chosen, the options for this parameter will show **P1-P3** (the server card slot that transmits and receives NMS information).

The Default IP Slot option is not used when default IP port is set to **nX64**.

DEFAULT IP UNIT

The Default IP Unit (Figure 5-8) options are determined by the choice of Default IP Port. If **off** or **local** is selected for that parameter, this option will show **n/a**. If **wan** is selected above, the options for this parameter will be **1-2** (corresponding with the WAN port). If **nX64** is selected above, the options for this parameter will be **C1, C2, C3 and C4**.

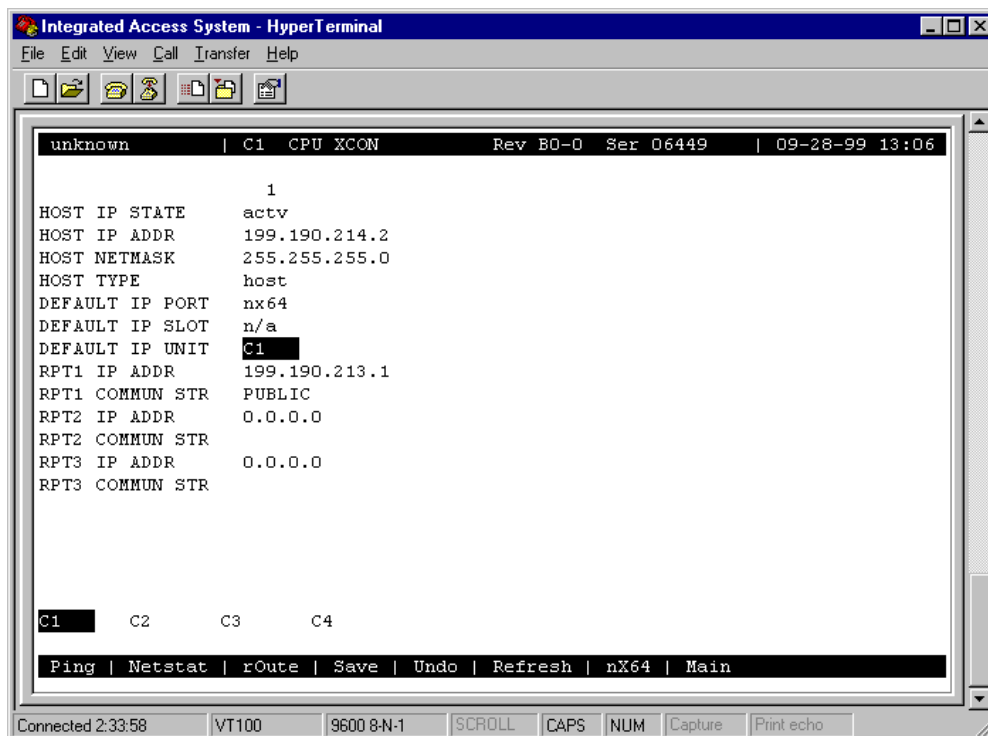

Figure 5-8. CPU Default IP Unit Selection Screen

RPT1 IP ADDR

The RPT1 IP Address is the IP address of the first Network Management System host running an SNMP trap server.

RPT1 COMMUN STR

The RPT1 Community String holds the community string for the first NMS host running a SNMP trap server. The community string provides additional security by rejecting messages that do not contain the correct string. *There must be some entry in this field to enable RPT1.*

RPT2 IP ADDR

The RPT2 IP Address is the IP address of the second Network Management System host running a SNMP trap server.

RPT2 COMMUN STR

The RPT2 Community String holds the community string for the second NMS host running a SNMP trap server. The community string provides additional security by rejecting messages that do not contain the correct string. *There must be some entry in this field to enable RPT2.*

RPT3 IP ADDR

The RPT3 IP Address is the IP address of the third Network Management System host running an SNMP trap server.

RPT3 COMMUN STR

The RPT3 Community String holds the community string for the third NMS host running a SNMP trap server. The community string provides additional security by rejecting messages that do not contain the correct string. *There must be an entry in this field to enable RPT3.*

5.4.1 Network Statistics Screens

The Network Statistics Screens provide maintenance and diagnostic information for the different protocols supported by this equipment. The system starts accumulating statistics when the TCP/IP Port is changed from **off** to **local** or **wan**, and it continues to store information until it is turned off.

Figure 5-9 shows the first of four Network Statistics Screens, and Figure 5-10 through Figure 5-12 show the other three screens. To go to the first screen, press “n” in the TCP/IP Screen to choose **Netstat** from the bottom line of that screen. Table 5-6 lists the actions that can be taken from the Network Statistics Screens, and the following paragraphs describe the parameters in each screen.

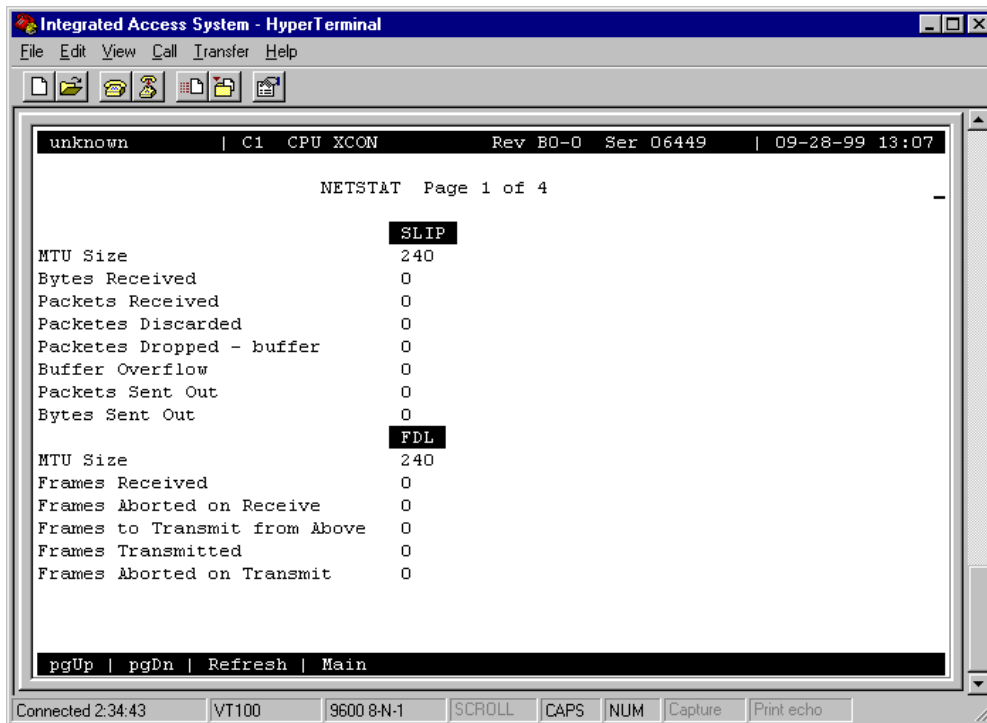

Figure 5-9. Typical Network Statistics Screen, Page 1

To move from one screen (page) to another, press “d” (**pgDn**) or “u” (**pgUp**). Pressing “d” goes to the next-highest page number. If you are on Page 4 when you press “d”, you will wrap around to Page 1. Pressing “u” goes to the next-lowest page number. If you are on Page 1 when you press “u”, you will wrap around to Page 4.

Table 5-6. Network Statistics Screen Actions

Action	Function
pgUp	Scrolls backward through network statistics, one page at a time. If you are on the first screen (Page 1), automatically “wraps around” back to the fourth screen (Page 4).
pgDn	Scrolls forward through network statistics, one page at a time. If you are on Page 4, automatically “wraps around” back to Page 1.
Refresh	Since the system does not update statistics automatically, the Refresh command must be used to update information in statistics fields.
Main	Returns to the TCP/IP Screen. If changes are made to settings and not saved, you will be prompted to save or lose changes.

5.4.1.1 SLIP Parameters

The Serial Line Interface Protocol (SLIP) parameters appear in the first Network Statistics Screen (Figure 5-10). These are described below.

MTU Size

The MTU (Maximum Transmission Unit) Size field shows the largest number of user-data (e.g., the largest size packet) that can be sent in a single frame. The MTU for this system is 240 bytes.

Bytes Received

The Bytes Received field shows the number of bytes received by the local system from the network host.

Packets Received

The Packets Received field shows the number of packets (unit of bytes, roughly similar to an IP datagram) received by the local system from the network host.

Packets Discarded

The Packets Discarded field shows the number of packets sent by the network host that were discarded by the local system. Packets are discarded because they either exceed the MTU or are not complete.

Packets Dropped - Buffer

The Packets Dropped - Buffer field shows the number of incoming packets that were dropped because there was not enough free memory to buffer them.

Buffer Overflow

The Buffer Overflow field shows the occurrences of buffer overflow at the local system.

Packets Sent Out

The Packets Sent Out field shows the number of packets transmitted by the local system to the network host.

Bytes Sent Out

The Bytes Sent Out field shows the number of bytes transmitted to the network host by the local system.

5.4.1.2 FDL Parameters

The FDL parameters also appear in the first Network Statistics Screen (Figure 5-9). They are described below.

MTU Size

The MTU (Maximum Transmission Unit) Size field shows the largest number of bytes that can be sent in a single frame. The default MTU is 240 bytes.

Frames Received

The Frames Received field shows the number of frames received by the local system from the network host.

Frames Aborted on Receive

The Frames Aborted on Receive field shows the number of frames that were aborted when received by the local system from the network host. Frames are aborted because they either exceed the MTU or are not complete.

Frames to Transmit from Above

The Frames to Transmit from Above field shows the number of frames that were sent by the local system to the TCP layer of the network host.

Frames Transmitted

The Frames Transmitted field shows the number of frames sent from the local system to the network host.

Frames Aborted on Transmit

The Frames Aborted on Transmit field shows the number of frames aborted when transmitted by the local system to the network host. Frames are aborted because they either exceed the MTU or are not complete.

5.4.1.3 IP Parameters

The IP parameters appear in the second Network Statistics Screen (Figure 5-10). These are described below.

```

Integrated Access System - HyperTerminal
File Edit View Call Transfer Help
unknown | C1 CPU XCON Rev B0-0 Ser 06449 | 09-28-99 13:08
NETSTAT Page 2 of 4
IP
Default TTL                255
Datagrams Received         0
Datagrams Discarded        0
Datagrams Delivered Above  0
Datagrams From Above       0
Datagrams Sent             0
TX Discarded - RAM         0
TX Discarded - mailbox short 0
TX Discarded - other       0
ICMP
Messages Sent              0
Echo Requests Received     0
Echo Replies Sent          0
Echo Requests Sent         0
Echo Replies Received      0
Dest Unreachable Sent      0
pgUp | pgDn | Refresh | Main
Connected 2:35:34 | VT100 | 9600 8-N-1 | SCROLL | CAPS | NUM | Capture | Print echo

```

Figure 5-10. Typical Network Statistics Screen, Page 2

Default TTL

The Default TTL field shows the Time To Live for information packets from transmission to delivery. The TTL for this system is 255 seconds.

Datagrams Received

The Datagrams Received field shows the number of IP datagrams (packets) received by the local system from the network host.

Datagrams Discarded

The Datagrams Discarded field shows the number of datagrams that were discarded by the local system.

Datagrams Delivered Above

The Datagrams Delivered Above field shows the number of datagrams sent to the TCP layer of the network host to the local system.

Datagrams From Above

The Datagrams From Above field shows the number of information or traps sent by the local system to the UDP or TCP layer of the network host.

Datagrams Sent

The Datagrams Sent field shows the total number of datagrams sent by the local system to the network host.

TX Discarded - RAM

The TX Discarded - RAM field shows the total number of datagrams sent by the local system that were discarded due to lack of free RAM memory.

TX Discarded - Mailbox Short

The TX Discarded - mailbox short field shows the total number of datagrams aborted by the local system because of a mail subsystem overflow.

TX Discarded - Other

The TX Discarded - other field shows the total number of datagrams discarded due to other causes.

5.4.1.4 ICMP Parameters

The ICMP parameters also appear in the second Network Statistics Screen (Figure 5-10). They are described below.

Messages Sent

The Messages Sent field shows the number of ICMP messages sent by the local system to the network host.

Echo Requests Received

The Echo Requests Received field shows the number of "ping" message requests received by local system by the network host. This figure is part of the total messages received.

Echo Replies Sent

The Echo Replies Sent field shows the number of "ping" message requests transmitted to the network host. This figure is part of the total messages sent.

Echo Requests Sent

The Echo Requests Sent field shows the number of "ping" requests sent to the network host by the local system. This figure is part of the total messages sent.

Echo Replies Received

The Echo Replies Received field shows the number of "ping" message replies received by the local system. This figure is part of the total messages received.

Destination Unreachable Sent

The Destination Unreachable Sent field shows the number of ICMP messages that were discarded upon receipt by the network host because they were improperly addressed.

5.4.1.5 TCP State Parameters

The TCP state parameters appear in the third Network Statistics Screen (Figure 5-11). They are described below.

```

Integrated Access System - HyperTerminal
File Edit View Call Transfer Help
unknown | C1 CPU XCOM Rev B0-0 Ser 06449 | 09-28-99 13:08
NETSTAT Page 3 of 4
TCP State = LISTEN
Packets Received 0
Packets Discarded - Checksum 0
Packets Discarded - Port 0
Packets Discarded - Window 0
Bytes Delivered Above 0
Bytes From Above 0
Packets Sent 0
ACKs Received 0
Packets Sent - reset 0
Packets Sent - ACK 0
Packets Retransmitted 0
RTT Increased 0
RTT Decreased 0
Connections Opened 0
Connections Closed 0
Connections Aborted 0
Packets Tx Aborted - RAM 0
pgUp | pgDn | Refresh | Main
Connected 2:36:02 VT100 9600 8-N-1 SCROLL CAPS NUM Capture Print echo

```

Figure 5-11. Typical Network Statistics Screen, Page 3

Packets Received

The Packets Received field shows the number of TCP packets received by the local system from the network host.

Packets Discarded - Checksum

The Packets Discarded - Checksum field shows the number of TCP packets that were discarded by the local system because the checksum failed.

Packets Discarded - Port

The Packets Discarded - Port field shows the number of TCP packets that were discarded by the local system because the port assignment was incorrect.

Packets Discarded - Window

The Packets Discarded - Window field shows the number of TCP packets that were discarded by the local system because the window data was incorrect.

Bytes Delivered Above

The Bytes Delivered Above field shows the number of information or traps sent from TCP layer of the network host to the local system.

Bytes From Above

The Bytes From Above field shows the number of information or traps sent to the TCP layer of the network host from the local system.

Packets Sent

The Packets Sent field shows the total number of TCP packets that were transmitted to the network host by the local system.

ACKs Received

The ACKS Received field shows the total number of acknowledgments that were received by the local system from the network host.

Packets Sent - Reset

The Packets Sent - reset field shows the total number of TCP packets that were transmitted by the network host to the local system.

Packets Sent- ACK

The Packets Sent - ACK field shows the total number of TCP acknowledgment packets that were transmitted by the network host to the local system.

Packets Retransmitted

The Packets Retransmitted field shows the total number of TCP packets that were retransmitted by the local system to the network host.

RTT Increased

The RTT Increased field shows the number of times the retransmission time-out was increased because the system was busy.

RTT Decreased

The RTT Decreased field shows the number of times the retransmission time-out was decreased because the system was not busy.

Connections Opened

The Connections Opened field shows the total number of connections that were opened by the local system to the network host.

Connections Closed

The Connections Closed field shows the total number of connections that were closed by the local system to the network host.

Connections Aborted

The Connections Aborted field shows the number of times the connection was aborted because either the number of consecutive retransmissions was equal to 10 or retransmission time-out was equal to 15 minutes.

Packets TX Aborted - RAM

The Packets TX Aborted - RAM field shows the total number of packets sent by the local system which were aborted because of the lack of free RAM memory.

5.4.1.6 UDP Parameters

The UDP parameters appear in the fourth Network Statistics Screen (Figure 5-12). They are described below.

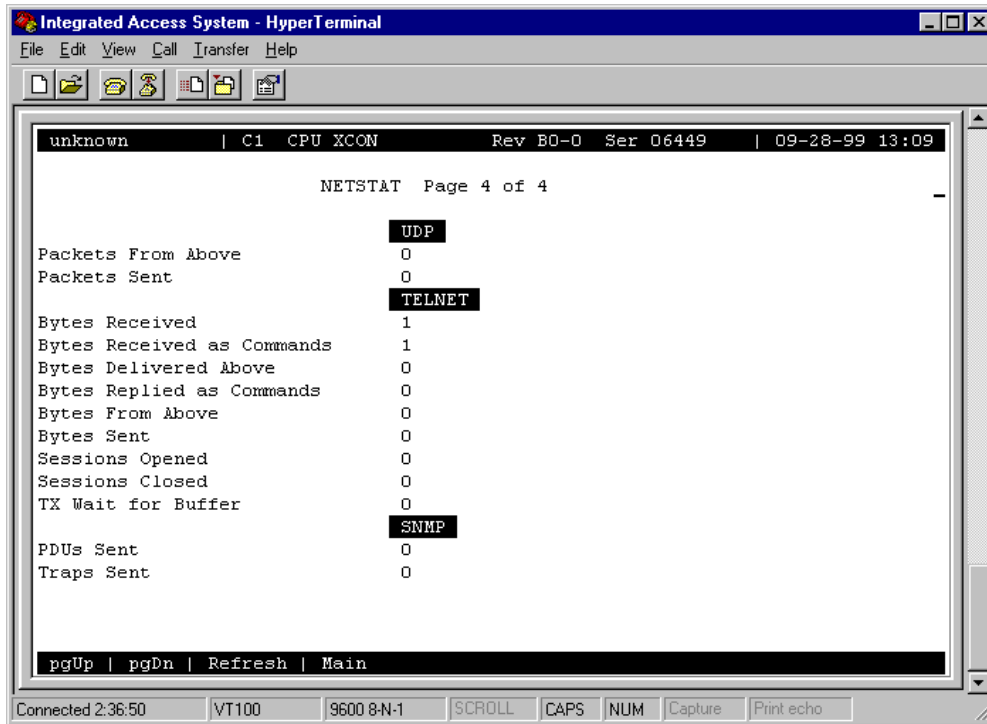

Figure 5-12. Typical Network Statistics Screen, Page 4

Packets From Above

The Packets From Above field shows the number of UDP packets sent by the local system to the network host.

Packets Sent

The Packets Sent field shows the number of UDP packets transmitted from the local system to the network host.

5.4.1.7 TELNET Parameters

The TELNET parameters also appear in the fourth Network Statistics Screen (Figure 5-12). They are described below.

Bytes Received

The Bytes Received field shows the total number of bytes that were received by the local system from the network host.

Bytes Receive as Commands

The Bytes Received as Commands field shows the total number of bytes that were received as commands by the local network from the network host.

Bytes Delivered Above

The Bytes Delivered Above field shows the total number of bytes that were transmitted by the network host to the local system.

Bytes Replied as Commands

The Bytes Replied as Commands field shows the total number of bytes that were transmitted as commands by the local system to the network host.

Bytes From Above

The Bytes From Above field shows the total number of bytes that were received by the network host from the local system.

Bytes Sent

The Bytes Sent field shows the total number of bytes that were transmitted by the local system to the network host.

Sessions Opened

The Sessions Opened field shows the total number of sessions that were opened by the local system with the network host.

Sessions Closed

The Sessions Closed field shows the total number of sessions that were closed by the local system with the network host.

TX Wait for Buffer

The TX Wait for Buffer field shows the total number of transmissions that were delayed by the local system for free memory in the buffer.

5.4.1.8 SNMP Parameters

The TELNET parameters also appear in the fourth Network Statistics Screen (Figure 5-12). They are described below.

PDU Sent

The PDUs Sent field shows the number of Protocol Data Units sent from the local system. A Protocol Data Unit is a data object exchanged by protocol drivers, usually containing both protocol control information and user data.

Traps Sent

The Traps Sent field shows the total number of SNMP traps that were transmitted by the local system to the network host.

5.5 IP Packet Routing

The Integrated Access System supports multipoint routing of Internet Protocol (IP) between all of its interfaces. These are: Serial Computer Port Interface, Server card interface (service depends on type of card), 4 nx64 interfaces, and 8 WAN interfaces using FDL or B7R time slot 24 of a D4-framed T1 link, or the Facility Data Link (FDL) of an ESF-framed T1 link. For E1 links IP datagrams are forwarded using time slot 31 or the SA4 (national) bit.

To use B7R, FDL, or SA4, you must make an additional selection on the associated WAN card. For T1 links, the selection is made via the ESF/NMS RP parameter. For E1 links, it is made via the COM/NMS RP parameter. Refer to WAN Card and B7R Card Chapters for further information.

All packets arriving on any of the optional paths or the local port will be treated by the IP stack as follows:

- If the packet's destination address matches that system's address, the packet is processed locally.
- If the address is not the same, the unit will search the routing table to find a remote address that matches the destination of the packet.
- If a match is not found for the packet, it is routed to the interface specified in the DEF DEST field. If the default destination matches the interface the packet arrived from, the packet is dropped.
- IP datagrams generated as a response to a request is sent back on the same interface it was received from. For this reason, 'ping' may work without even though the routing table is not set up.

Figure 5-13 shows a typical routing arrangement. Although 24 units are used in this example, the number of remote units is unlimited except for bandwidth and link-down considerations.

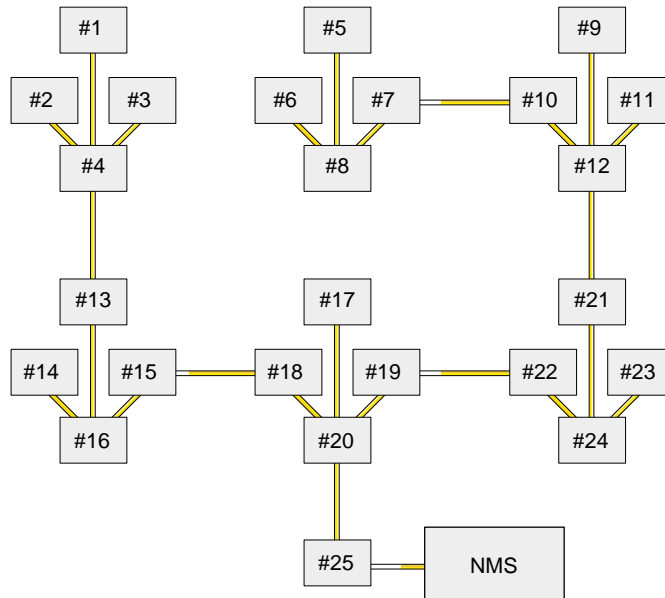

Figure 5-13. Typical Routing Diagram

In Figure 5-13, 24 system units transmit alarm information to an IP routing system unit (System 25) via the optional paths of separate WAN links. The network administrator assigns IP addresses for each system on the TCP/IP screen of each system's ICPU card (HOST IP ADDR). System 20 is connected by any of the optional paths to System 25, which supports NMS equipment (the communications server) with either a local SLIP connection directly from the CPU card or any optional path of a T1 or E1 WAN link. In this example, all alarms received by any of the system units will be forwarded via system 25 to the NMS over a single WAN link.

Each of the 24 reporting units use NMS's IP address as the RPT1 IP ADDR on the TCP/IP screen of its CPU card.

The local port is included to be able to transmit the IP packets generated by the routing unit to the same destination. In most cases, the DEF DEST of all units controlled by this router will be the same place (either the local port or optional WAN paths to a distant location).

The Routing screen column headings are associated with the incoming WAN link associated with the IP location of the remote systems. For example, if you expect incoming information from system 1 on WAN 1-1, you assign the IP address for system 1 IP NET for WAN 1-1.

Figure 5-14 shows the Routing Screen, and Table 5-7 lists the actions that can be performed from that screen. Table 5-8 summarizes the available option settings and defaults for that screen.

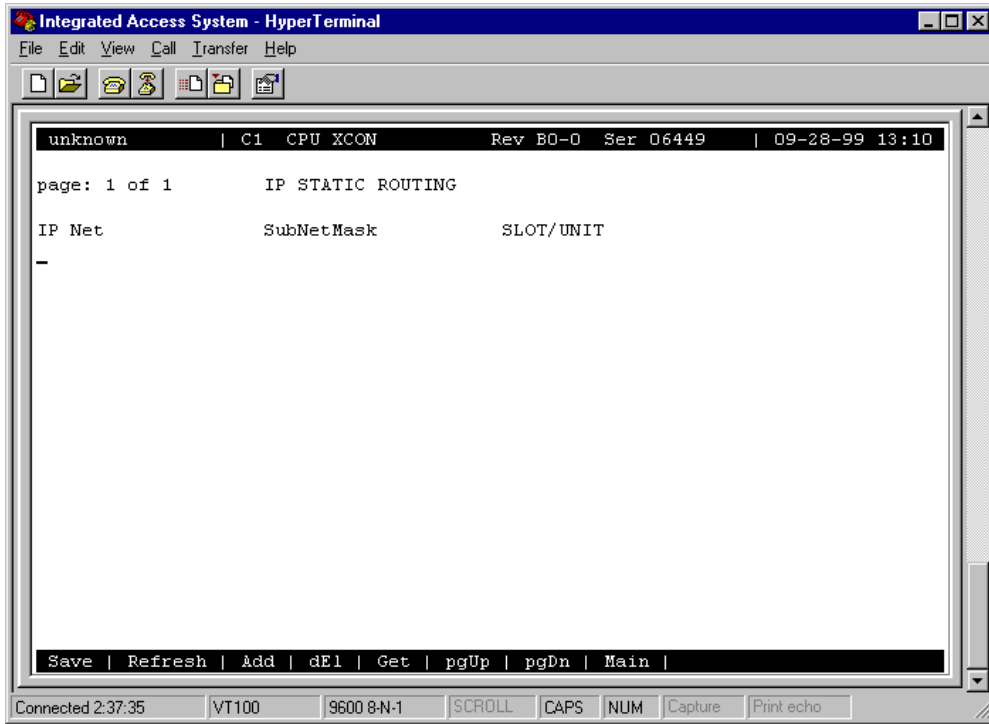

Figure 5-14. Typical IP Routing Screen

Table 5-7. Routing Screen Actions

Action	Function
Save	Saves changes to settings.
Refresh	Used on Testing and Monitoring screens to update statistics and on other screens to redraw the screen.
Add	Open the data entry screen to add a route
dEl	Delete a route
Get	Get information on routing destinations
PgUp	Go to a previous page of routing paths
PdDn	Go to the next page of routing paths
Main	Returns to the CPU card main screen. If changes are made to settings and not saved, you will be prompted to save or lose changes.

Table 5-8. Settings for Routing Parameters

Parameter	User Options	Default
IP NET	a valid IP address	0.0.0.0
SUBNETMASK	a valid Netmask IP address	0.0.0.0

SLOT/UNIT	wan: W1-1 through W4-2 serv: P1-P3 user: not supported local: COMP nX64: C1 through C4	w1-1
-----------	--	------

IP NET

The IP Net field shows the IP address of a device located on this system unit. This must be a valid IP address.

SUBNETMASK

The Remote Netmask field shows the Netmask of a device located remotely from this system. Any valid Netmask is acceptable. The remote netmask information is the same as that placed on the remote unit's TCP/IP screen.

SLOT/UNIT

The Default Destination specifies where to route packets received from a remote device and the routing device to downstream NMS equipment (either the optional paths of a WAN link or the local SLIP port).

Adding Routes

In the Routing Screen, type "a" (**Add**) to present a data entry screen. A data line appears near the bottom of the screen for the three address parameters of Table 5-8. Use the right/left arrow keys to move to the desired field. Press <Enter> to present the corresponding data entry field (Figure 5-15). Type in the correct address parameters, up to three digits (0-255) in each segment of the address, using the right arrow key to move to the next segment. Press <Enter> again to move the entered address into the data line. Use the left/right arrow keys to move on to the SubNet Mask and repeat the process. The Slot/Unit field offers the entry categories shown in Figure 5-16. Scroll to the desired category and press <Enter> to present one of the choices shown in Table 5-9. Scroll to the desired value and press <Enter>. When valid address and destination parameters have been added, type "s" to **save** the address (Figure 5-17). The system will not save an invalid address. To exit the Add screen without saving press the up or down arrow keys.

Delete a Route

In the Routing Screen, scroll to the route to be deleted. With the route highlighted, press e to delete.

Get Information

To obtain addressing information, press **g** for Get. The system displays the destination variables wan, serv, user, and local across the bottom of the screen. Use the left/right arrow keys to scroll to the desired destination and press <Enter> to select. The choices available under each of these options are then displayed. Now highlight the desired option and press <Enter> again to initiate the search. The system responds:

```

Sending RIP Request. Please wait ...
Press any key to cancel

```

After the system send RIP request, the IP Static Routing screen will return, displaying valid IP Net (address), SubNetMask, and Slot/Unit information.

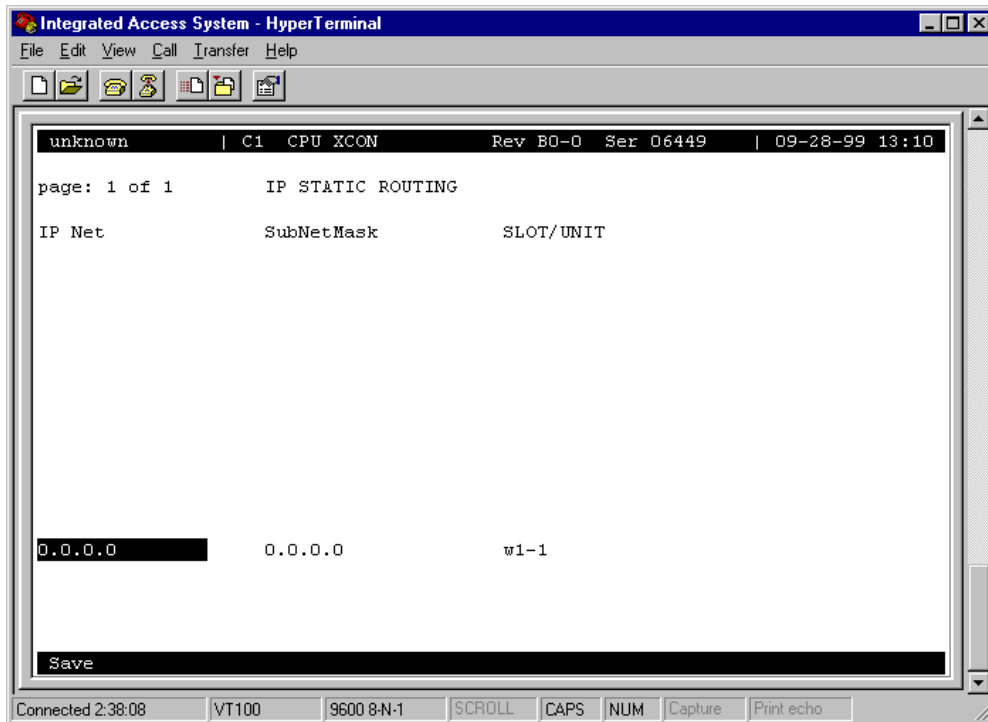

Figure 5-15. Routing Address Entry Screen

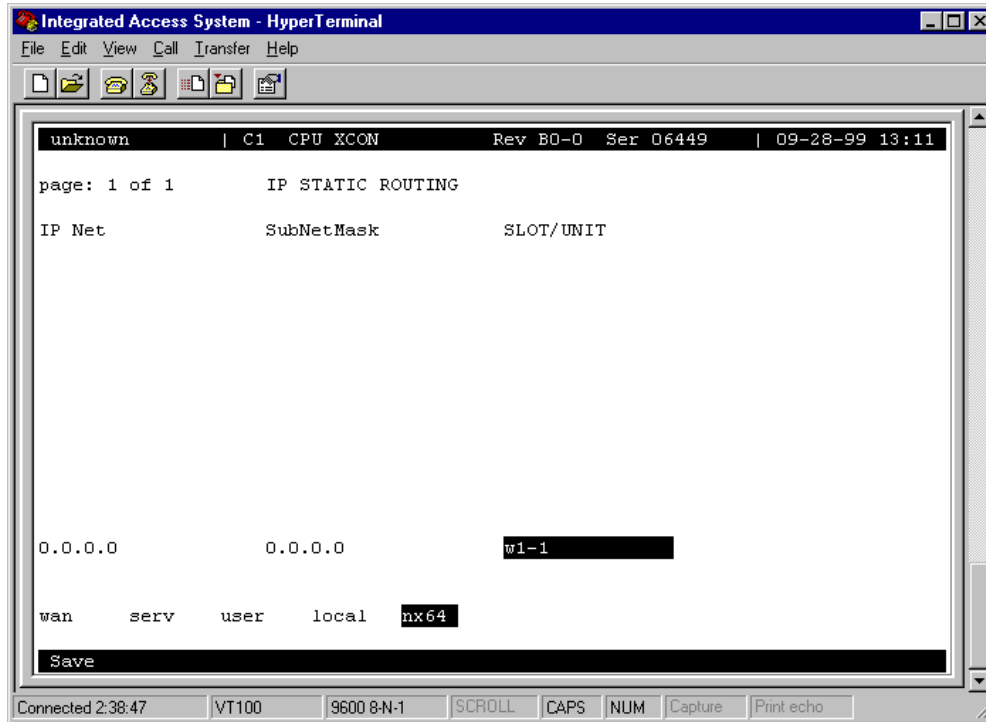

Figure 5-16. Slot/Unit Options Screen

Table 5-9. Slot/Unit Options

Slot/Unit Options	Description	Default
WAN	w1-1 w1-2 w2-1 w2-2 w3-1 w3-2 w4-1 w4-2	w1-1
SERV	P1 P2 P3	P1
USER	not supported	n/a
LOCAL	IF-2	IF-2
nX64	C1 through C4	C1

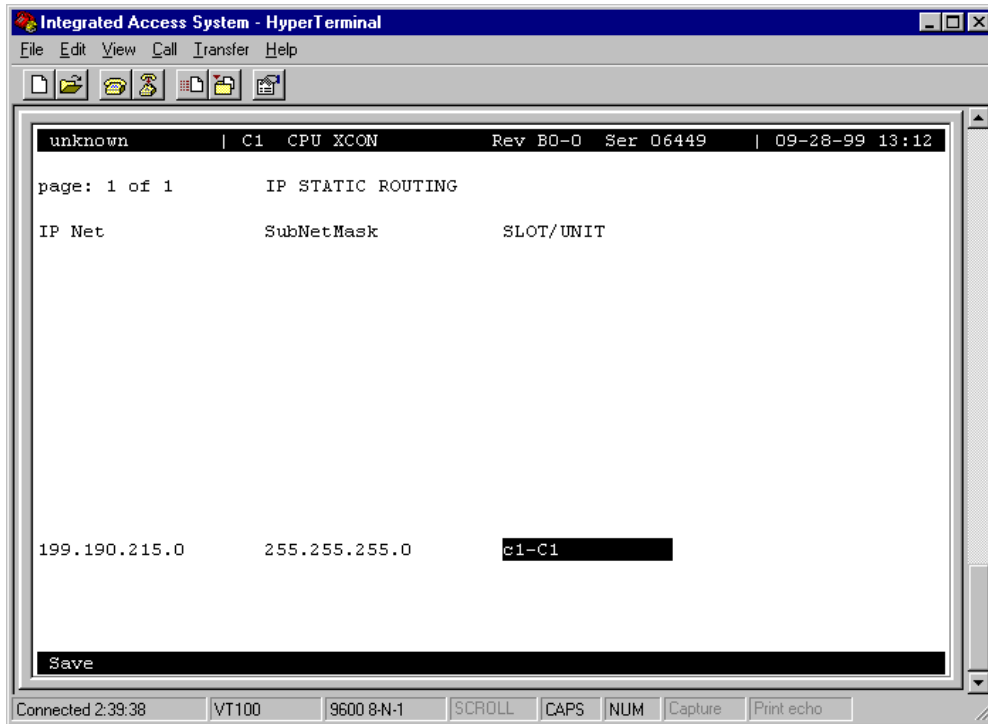

Figure 5-17. IP Static Routing Information Screen

5.5.1 nX64 Screen

The Enhanced NMS Connectivity screen (Figure 5-18) provides a solution to increase bandwidth channel for management purposes. FDL was previously the answer to this need for not consuming valuable bandwidth. However, by giving up a time slot the increase of bandwidth provided better connectivity allowing a variable bandwidth from 56 Kbps to 1.54 Mbps for T1 and 2 Mbps for E1. A single 1x64 kbps channel improves the bandwidth over FDL 16 times.

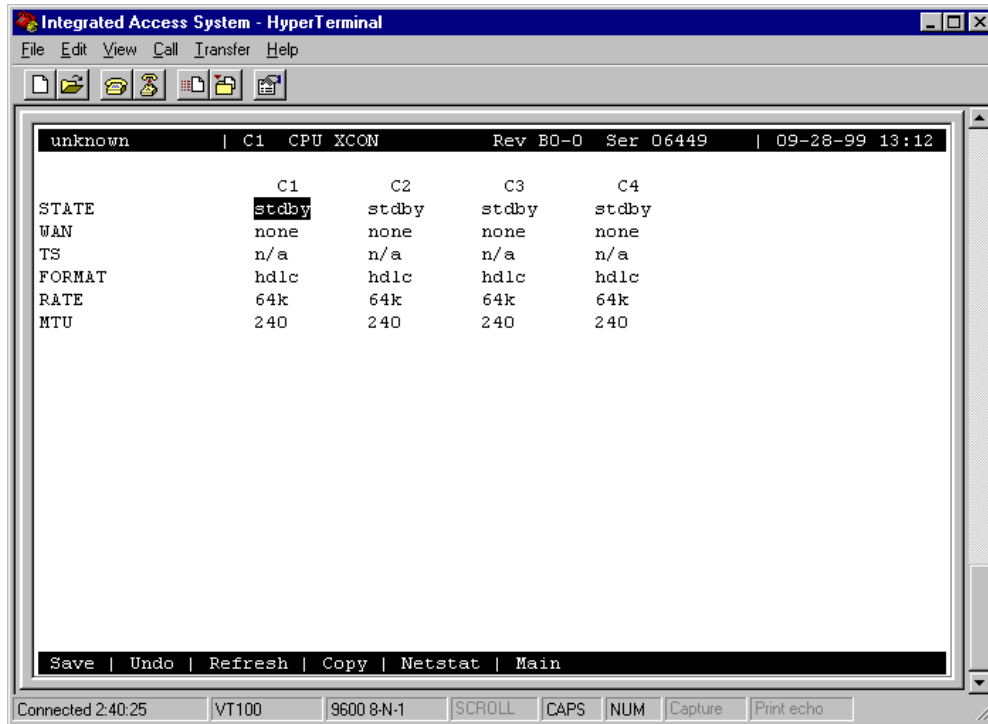

Figure 5-18. nX64 Main Screen

The 5.x CPU includes four controllers for use in various types of communication. All four controllers are mapped through two TSA (Time Slot Assigner) devices and will share a common pool of 64 time slots. The TSAs are cross-connected to the TDM (Time Division Multiplexing) bus via MTUSs (Memory Time Switches).

Currently, the four nx64 ports can only be assigned to WAN resources.

The four available channels may be configured at nx64 kpbs, using plain HDLC for communication with other Integrated Access Systems, or using RFC1490 encapsulation for connectivity to other Integrated Access Systems as well as the Frame Relay public network.

Table 5-10. nX64 Screen Actions

Action	Function
Save	Saves changes to settings.
Undo	Returns all settings to the last saved state.
Refresh	Used on Testing and Monitoring screens to update statistics, and on other screens to redraw the screen.
Copy	Copies settings to next available slot
Netstat	Displays the Network Statistics Screen. See below.
Main	Returns to the CPU card main screen. If changes are made to settings and not saved, you will be prompted to save or lose changes.

Table 5-11. nX64 Screen Options and Defaults

Parameter	User Options	Default
STATE	actv stdby	stdby
WAN/SERV	none wan (w1-1, w1-2, w2-1, w2-2, w3-1, w3-2, w4-1, w4-2)	none
TS	n/a 1-24(T1) 1-31(E1)	no
FORMAT	hdlc fr ether	hdlc
RATE	56k 64k	64k
MTU	<128 - 1500>	240

STATE

The state indicates whether the port is enabled or disabled. Upon activation all parameters are validated. The selected IP address and netmask must be valid. The WAN must be available, and the selected combination of time slots must be available to activate the port. Default state is **stdby**.

WAN

This parameter indicates which WAN/SERV the nX64 can be connected to. The WAN selected should be available. If the selected WAN is removed and deleted, the port should be set to **stdby**. Default WAN is none.

TS

This table shows 24 selectable time slots when configured for T1, 31 selectable time slots when configured for E1. Time slot 16 is only available if TS16 is set to **nos** from the WAN screen. No time slots are selected as default.

FORMAT

The format indicates which format is selected for the given nX64 communications port. Possible options are HDLC, Frame Relay and Ethernet. Ethernet is only allowed for communications port1. Default setting is HDLC.

RATE

The Rate setting allows you to adjust the speed of the circuit according to the application requirements. The only speed available for ports C1 to C4 is **64k** (64 kbps). However, ports 1 to 64 can be set to either **56k** or **64k**.

MTU

The MTU needs to be 240 for 1x64 in order to communicate with the MCC. Since the MTU is desired larger than that this needs to be a configurable option. Dependent on implementation this can either be a number entered in a given range, or the selection from a predefined list of fixed MTU sizes.

5.5.2 Network Statistics Screen

Figure 5-19 shows the Netstat screen for the network statistics at the interface level for the selected nX64 communications port. The IP stack netstat is available from the standard CPU IP screen.

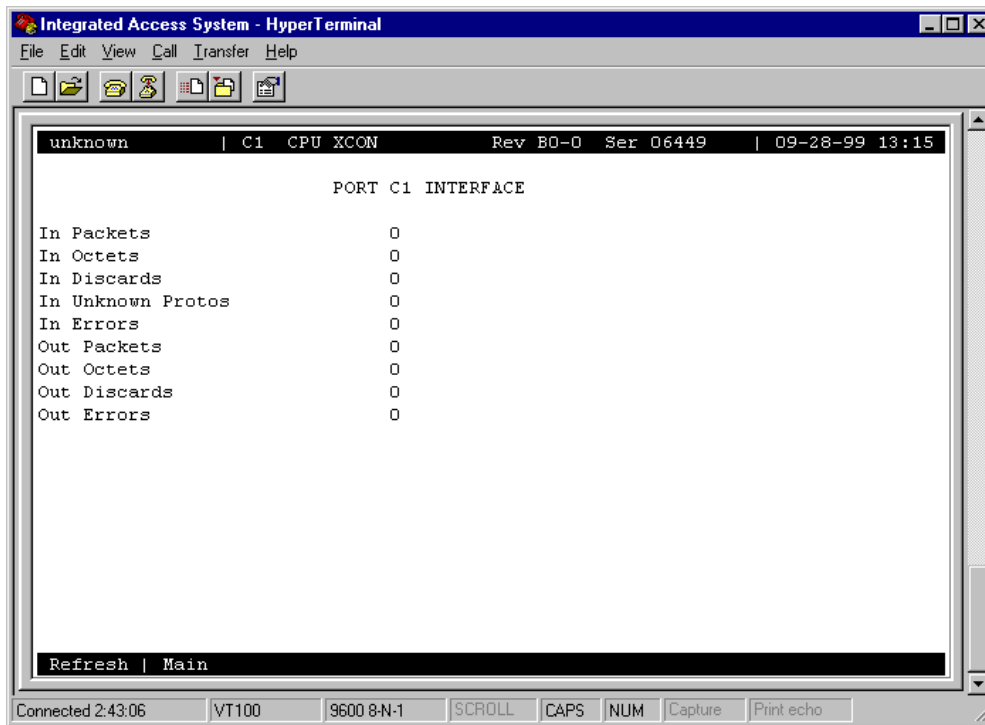

Figure 5-19. nX64 Netstat Screen

Table 5-12. nx64 Netstat Screen Actions

Action	Function
Refresh	Used on Testing and Monitoring screens to update statistics, and on other screens to redraw the screen.
Main	Returns to the CPU card main screen. If changes are made to settings and not saved, you will be prompted to save or lose changes.

5.6 CPU Host Software Upgrade Procedure

This section provides procedures for upgrading Integrated Access System host software. The procedures for upgrading from 5.0.0 to 5.1.4, and from 5.0.1 or greater, to 5.1.4.

The CPU-5 XCON card contains the host software that controls the Integrated Access System. The host software is stored in flash memory facilitating download of future software releases to the CPU card.

Version 5.0.0 of the host software utilizes kernel 5.0.0, while all other versions including 5.1.4 host software use kernel 5.0.1. To upgrade to the 5.1.4 host, the CPU(s) must be replaced with CPU(s) that contain the new 5.1.4 host software containing the new 5.0.1 kernel. CPUs with 5.0.1 host software or above already use the 5.0.1 kernel and can be upgraded by flash download as outlined in the procedures in Section 5.7 on page 5-40.

5.6.1 Equipment Requirements

Following are the equipment requirements for CPU host software upgrade.

- CPU-5 XCON's equipped with 5.0.1 or greater host software
- Laptop computer running Windows 3.1, 95, or 98
- Serial port cable to connect to the TERM port on the Integrated Access System
- Host software 5.1.4 on disk or loaded into laptop computer

5.6.2 Laptop Setup

Follow the steps listed below to set up the laptop computer.

1. Boot the laptop.
2. Click **"START"**.
3. Select **"Programs"**, **"Accessories"**, and click on **"HyperTerminal"**.
4. In the HyperTerminal window, double click on **"Hypertrm"** icon.
5. In the *New Connection* window, *Enter Name:* enter **Upgrade**.
6. Select icon and click **OK**.
7. In *Connect to Window*, *Connect Using*, click down arrow and select **"Direct to COM1"**.
8. Click **OK**.

9. In COM 1 window, set BITS per second to “9600” (leave other settings as is) click **OK**.
10. In Upgrade window, click **File** menu, select **Properties**, and select **Settings**.
11. In Emulation window, select **VT100** and click **Terminal Setup**.
12. Select **132 column mode**, click **OK**.
13. Close **Properties** window and save.
14. Right click on **Upgrade Icon** and select **Create Shortcut**.
15. Drag shortcut to the desktop.

5.6.2.1 Log Upgrade Activity

Create a log to record upgrade activity on a per-site basis that includes the following information:

- Site name, date and time, and name of technician performing upgrade
- System name(s) and number of CPU cards per system
- Model, serial number, and host version of previous CPU cards
- Model, serial number, and host version of new CPU cards
- Model and serial number of Interface card

5.6.3 Upgrade Preparation

Follow the steps listed below to perform an upgrade.

1. Connect the laptop to the TERM port on the Integrated Access System.
2. Press **Enter**, and log into the system.
3. Using the arrow keys, move the cursor to **CPU** and press **Enter**.
4. Verify and record the current host software version.
5. Determine one of the following upgrade methods to be used:
 - Replace the CPU if the current version is 5.0.0, or
 - Download flash if the version is 5.0.1 or above.

5.6.3.1 Upgrade from 5.0.0 to 5.1.4

Follow the steps listed below to perform an upgrade from host software.

1. Record the serial number of the new CPU(s).
2. Replace the current CPU(s) with new 5.1.4 CPU(s). The system will briefly display the Test and Initialization screen and then appear blank. Press the **Enter** key and the Login screen will appear.
3. Log into the system and verify that system information is correct.
4. Using the arrow keys, move the cursor to the CPU and press **Enter**.
5. Verify that the host software version is 5.1.4.
6. Logout of system and repeat procedure for each system at the site.

5.6.3.2 Upgrade from 5.0.1 or greater

Follow the steps listed below to perform an upgrade from host software.

Log into the system and follow procedures as detailed in Section 5.7 following.

5.7 Software Download Procedures

5.7.1 CPU Swap

The first and easiest way to accomplish a field upgrade is to order an upgraded CPU from the manufacturer and swap the CPUs at the CPE site. Following are instructions for swapping the CPU cards.

1. Loosen the screws from the top and bottom front panel on the existing CPU, and remove the card from the chassis.
2. Unpack the upgraded CPU and slide into the same slot in which the previous CPU resided (usually the C1 chassis slot).

Following the CPU swap, the system re-initializes. Upon completion of re-initialization, verify that all circuits are active and operating.

5.7.2 XMODEM Protocol Binary Download

Follow the steps listed below to perform an XMODEM protocol bin download.

1. Set up a direct connection to the VT-100 craft port.
2. Locally connect the PC to the VT-100 craft port. Log into the system with the *Superuser* password.
3. Highlight the active CPU and press “P”.
4. The binary buffer area appears, and one of the buffers displays in an active state. The other buffer may be empty or may have a file in it. Verify that the kernel version on the lower half of this screen indicates *5.0.1* with a *checksum* of *0x12A459*.
5. If both buffers have files in them, highlight the buffer that is not active. Press the **Enter** key and four options appear at the bottom of the screen. Using the arrow keys, highlight the *erase* parameter and press **Enter**. When the system finishes erasing the buffer it will indicate an empty state.
6. Using the arrow keys, highlight the *empty buffer* area and press **Enter**. Four parameters will appear on the screen. Using the arrow keys, select the *dnload* (download) parameter and press **Enter**. Two parameters will appear at the bottom of the screen.
7. Using the arrow keys, select the *XMODEM* parameter and press **Enter**. The letter “C” will begin duplicating across the screen. This is normal and does not indicate a problem.
8. At the HyperTerminal screen, select *file transfer* and send the file. Choose the appropriate binary file to download using the *XMODEM1K* protocol to BIN buffer 1 or 2, depending upon which bin is empty. The binary file being downloaded **must** match the BIN number into which it is loading, and the binary file will be marked with either a 1 or a 2 accordingly.
9. Following completion of the download process, make the newly loaded bin active and then erase the existing firmware from the now inactive bin. Perform the download process again so that both buffers have the same firmware applied to them.

5.7.3 Pre-TFTP Binary Upload/Download Preparation

To perform binary (bin) uploads/downloads via the TFTP function, one of the following two methods of connection to a Local Area Network (LAN) network must first be selected.

1. The first option requires that the system to which you will download be powered and running through an active MCC server card that is connected to a LAN. The connection must be made either in the box that will receive the downloaded file or in a remote box routed through the local CPU that is set as a gateway using an IP protocol. You must be able to ping the MCC card and the local and remote CPU host IP addresses from the PC or server that you intend to use as a TFTP server and vice versa. The DEF RTE on the MCC Ethernet configuration screen must be set to *static* and must include the IP address of the PC or server from which you are downloading the firmware. You may need to

change the routing table on your PC to include the MCC ethernet address as the gateway, or the local host address as the gateway for the system receiving the file as the destination IP address.

2. The second option is to connect to the Integrated Access System interface card's COM (C1) port to which you will download the firmware using PPP or SLIP protocol at 19.2k or 9.6k respectively. Again, you may need to change the routing table on your PC and/or on the router or terminal server through which the PPP/SLIP connection runs.



***Note:** Your PC must have some sort of TFTP or TFTP server software installed and running when you are downloading the binary files to the system. If you are using TFTP type software it is easier if you set the root directory to indicate where the binary file is located at the TFTP root screen. This eliminates the need to enter a path at the file name screen during the download process. If you are running a TFTP software package, consult the user guide accompanying the software for details on configuring and using the software.*

5.7.3.1 TFTP or TFTP Protocol Bin Download

Follow the steps listed below to perform a TFTP or TFTP protocol bin download.

1. Establish connection in one of the following methods:
 - Connection via Telnet
 - Direct connection to the Integrated Access System, using the SLIP/PPP connection via the computer port
 - Connection through the MCC card, using the TFTP or TFTP protocol
2. Log into the Integrated Access System using the *Superuser* password.
3. Highlight the appropriate CPU with the cursor and press “P”.
4. The binary buffer area appears, and one of the buffers will display an active state. The other buffer may be empty or may have a file in it. Verify that the kernel version on the lower half of this screen indicates *5.0.1* with a *checksum* of *0x12A459*.
5. If both buffers have files in them, highlight the buffer that is not active. Press the **Enter** key, and four options will appear at the bottom of the screen.
6. Using the arrow keys, highlight the *erase* parameter and press **Enter**. When the system finishes erasing the buffer it will indicate an empty state.
7. Using the arrow keys, highlight the empty buffer area and press **Enter**. Four option parameters will again appear.

8. Using the arrow keys, select the *download* parameter and press **Enter**. Two option parameters will appear at the bottom of the screen.
9. Highlight the *TFTP* parameter and press **Enter**.
10. A *mismatch retries* entry appears. Press **Enter** to invoke the default.
11. A *time-out retries* entry appears. Press **Enter** again to invoke the default.
12. An *IP address* option parameter appears. Enter the appropriate IP address of the PC or the TFTP server into this field and press **Enter**.
13. At this point a *file* parameter appears, prompting for the name of the file being downloaded to the system. Enter the file name as shown when scanning directories using the C:\DIR/W command and press **Enter**. If using Windows Explorer the file may be truncated and the system will not be able to find the file.

If the download process is successful, a decreasing number of bytes begins to appear on the screen. If something has been configured incorrectly, data will not be sent and following expiration of the time-outs an error message appears.

14. Upon successful download completion, set the inactive bin to active. This will place the newly loaded code into an active state and the system will perform a restart. Verify that all circuits are active and operating.
15. Repeat this same procedure on the inactive bin (previously the active bin) by erasing the existing firmware and downloading the new firmware so that both buffers have the same firmware applied to them.

5.8 CPU Card Error Messages

Refer to Appendix B in the System Reference Guide for further information on Error Messages regarding this card.

5.9 CPU Card Troubleshooting

On power-up, the CPU card performs a self-test. This is the only diagnostic available for the CPU. A “healthy” active CPU will have a green LED lit on the front panel. A “healthy” redundant CPU will flash between green and amber LEDs.

The indications that a CPU is not on-line are:

- Continuous amber alarm LED on front panel AFTER the system has been registered during initial installation. Prior to registration, the amber LED is an indication that registration needs to occur before the system can be fully operational.

- Inability to communicate with the system by any means (VT-100 Term, Telnet, etc.).

Because the CPU and Interface card work together to support a system, follow this general sequence:

1. Verify that the CPU card's US/EUR jumper (HD1) is correctly set to match the US/EUR jumper on the chassis.
2. Verify that both CPUs in a redundant system are of the same firmware revision.
3. First replace the CPU. If the problem continues, replace the Interface Card.



Note: Removal of an active CPU or Interface card will cause a service disruption on the entire system.

4. If the CPU card is determined to be faulty, replace it and return the faulty unit for repair to the location specified by your distributor.

5.10 CPU Card Specifications

CPU Card 880360		
LED Indicators		
Operation	Green for normal operation. Red for card fault or test mode. (Amber on Model 880360).	
Code storage		
Model 880360	Configurable with maximum 8 MB DRAM and 4 MB Flash Memory	
Operational Modes		
Model	Mode	Cross Connect
880360	cross-connect	yes
Maximum number of WAN links		
Model 880360	Up to 8 WAN links	
Support for CPU redundancy		
Model 880360	yes	
Support for WAN link redundancy		
Model 880360	1:N. A single model 8814 WAN card in slot W4 can provide back-up for identically configured 8810 WANs in slots W1 through W3.	
Support for Resource/Server Cards		
Model 880360	Support for all server cards	
Standards Compatibility		
Bellcore	GR-63-CORE Issue 1	Network Equipment-Building System (NEBS) Requirements: Physical Protections

CEN	EN 50 081-1	Electromagnetic compatibility generic emission standard Part 1 Residential, commercial and light industry
	EN 50 082-1	Electromagnetic compatibility generic immunity standard Part 1 Residential, commercial and light industry
	EN 60 950/A2	Safety of information technology equipment including electrical business equipment
UL	1950	UL Standard for Safety of Information Technology Equipment
CSA	C22.2, No. 950	Safety of information technology equipment including electrical business equipment

Chapter 6

Interface Card

6.1 Introduction

This chapter provides specific installation, configuration, and troubleshooting information for the Interface Cards of the Integrated Access System. These cards are labeled as the INF-E T1E1*8, INF+M T1E1*8, and INF cards, respectively, on their faceplate ejectors. Each card provides communications connections to the system for operator access and system control. Throughout this chapter, these cards are referred to as the INF-E, INF-M, and INF cards.

6.2 Interface Card Descriptions

6.2.1 INF-E Card Description (892261)

The INF-E card provides the communications, control, and network interface ports. It has a DB-9 male serial port for network management; this port is configured as DTE. It also has a RJ48 jack that connects it to the node port for alarm notification, and a local VT-100 terminal port. An RJ48 external sync port allows clocking from external primary and secondary clock sources. The INF-E card supports up to eight T1 or E1 WAN links (see Figure 6-1).

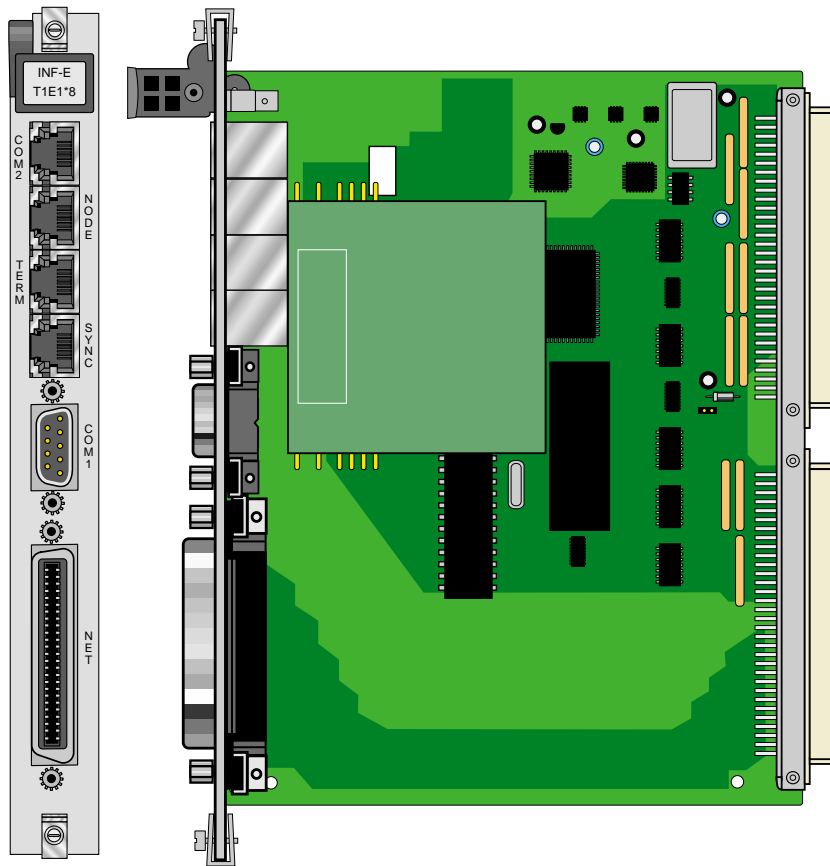

Figure 6-1. INF-E Interface Card (892260)

6.2.1.1 Card Jumper/Switch Settings

The INF-E card doesn't have any jumpers or switches on its mainboard.

6.2.1.2 Installing the INF-E Card

Install the INF-E card into the IF slot of the system chassis. Each system can have only one INF-E card.

6.2.1.3 External Sync Panel (1500)

When installed in a two-sided chassis, the INF-E card may be used in conjunction with an External Sync Panel.

6.2.1.4 External Sync Panel for Two-Sided Chassis (1500)

The External Timing Sync Panel is used to provide a means of terminating external clocking source inputs using wire-wrap techniques. (see Figure 6-2 for jumper arrangements diagram and Table 6-1 for jumper settings). The External Timing Sync Panel replaces the cover plate of the ringing supplies to the left of the Interface card (see Figure 6-3 and Figure 6-4).

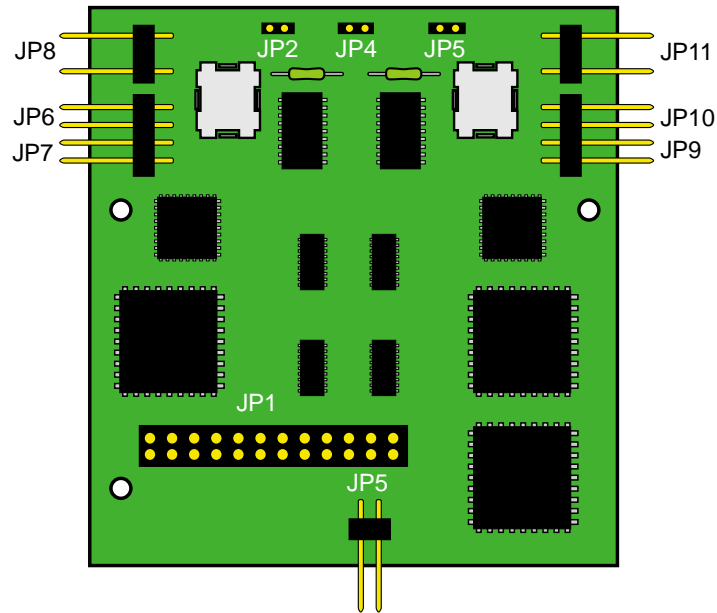

Figure 6-2. Jumper Arrangements for the T1/E1 External Sync Panel

Table 6-1. Jumper Settings for the T1/E1 External Sync Panel

Jumper #	Position	Results
JP5	Open	T1
JP5	Closed	E1
JP8	Open	Balanced
JP8	Closed	Unbalanced
JP6 and 7	Open	Ext1 (T1) 100 Ohms
JP9 and 10	Open	Ext2 (T1) 100 Ohms
JP6 and 7	Closed	Ext1 (E1) 75 Ohms
JP9 and 10	Closed	Ext2 (E1) 75 Ohms

6.2.1.5 Sync Panel for Two-Sided Chassis (1500)

The External Timing Sync Panel is used to provide external clocking source inputs (see Figure 6-4). It is located on the cover plate of the ringing supplies to the left of the Interface card (see Figure 6-3).

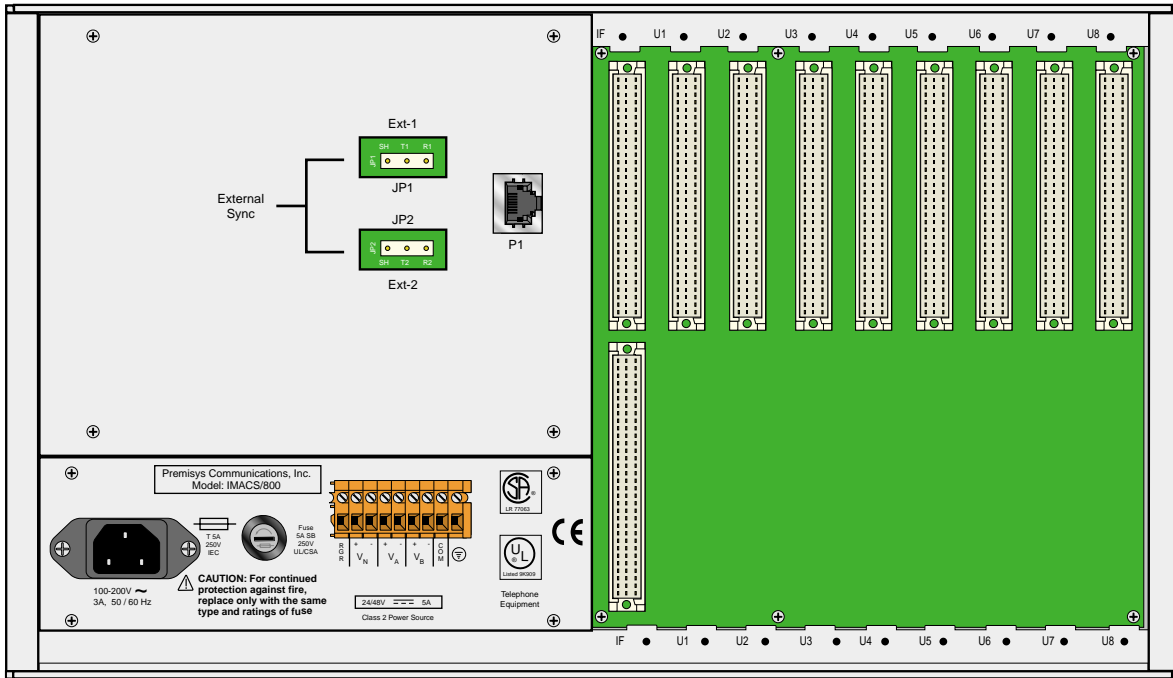

Figure 6-3. Two-Sided Chassis, Back View with External Sync Panel Installed

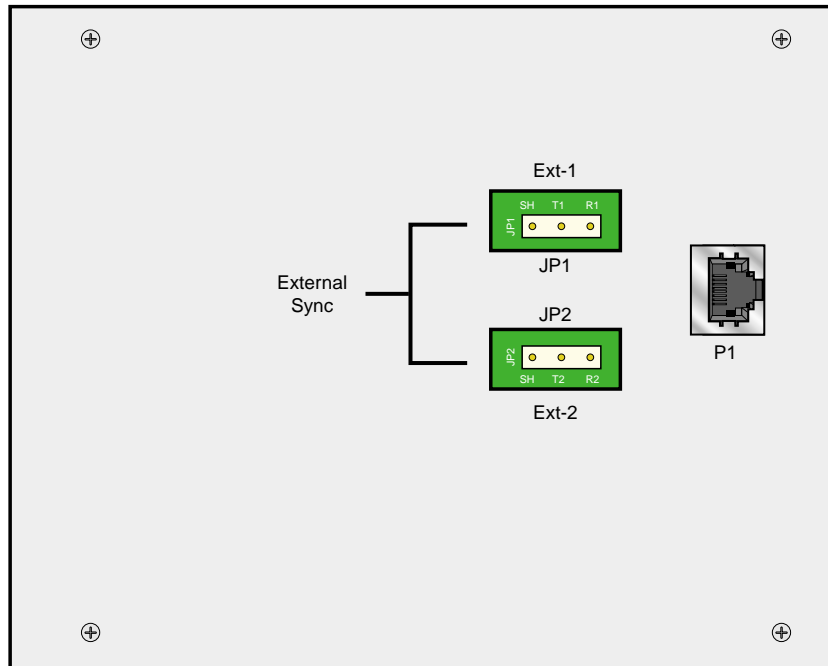

Figure 6-4. External Timing Sync Cover Panel (1500)

The pins shown in JP1 are used to wrap the wires from an externally provided clocking source. A standard wire-wrap tool is used to make the connection. The pins shown in JP2 are used to wrap the wires from a second external clocking source.

The Ext-1 (JP1) pins are labeled “Sh” (Shield Ground), “T1” (Tip1) and “R1” (Ring1) and the Ext-2 (JP2) pins are labeled “Sh” (Shield Ground), “T2” (Tip2) and “R2” (Ring2).

The RJ48 connection labeled P1 is used to connect the external timing to the external sync port on the Interface Card with a short module plug to plug cable. (This cable is provided with the system.) External clock sources are shown on the Interface card as **ext1** and **ext2** under Primary Clock and Secondary Clock.



Note: Refer to correction grounding procedures of external timing sources.

6.2.1.6 Equipment Grounding Requirements

When connecting cables from other AC-powered equipment (such as computer terminals) to the Interface card, **make sure the other equipment is properly grounded.** Ground connections are normally provided by the ground (third) prong of an AC plug. Some PCs, especially portables and laptops, have power supplies with two-pronged plugs; they are not properly grounded.

When a cable is run from a PC that is not properly grounded to the Interface port of the system, a high voltage differential (up to 100 VAC) may result between the system and the PC. This can severely damage the Interface card, PC, or both.

As a rule, all cards with data interface connectors (RS-232, RS-422, RS-530, etc.) could be damaged if connected to poorly grounded equipment. **All persons authorized to use or service the Integrated Access System should be familiar with good grounding practices.**

6.2.2 INF+M Card Description (892360)

The INF+M card has an internal modem that allows remote operator to communicate with the system. However, it does not accept external synchronization clocks. In all other respects, the INF+M card is functionally identical to the INF-E card (see Figure 6-5).

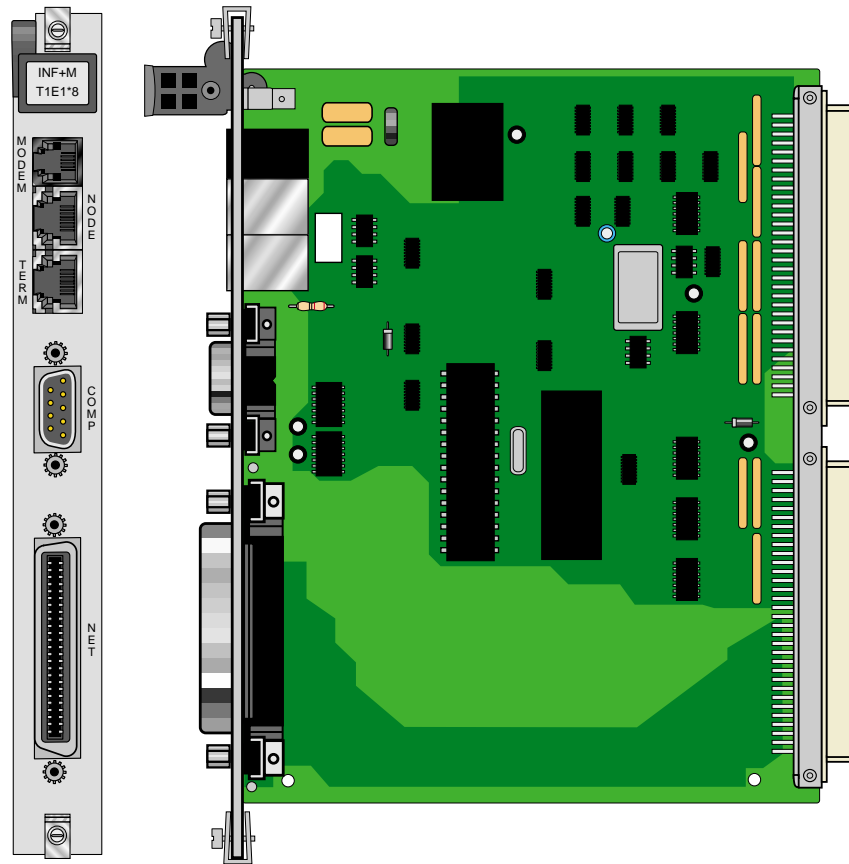

Figure 6-5. INF+M Interface Card (892360)

6.2.2.1 Card Jumper/Switch Settings

The INF+M card doesn't have any jumpers or switches on its mainboard.

6.2.2.2 Installing the INF+M Card

Install the INF+M card into the IF slot of the system chassis. Each system can have only one INF+M card.

6.2.3 INF Card Description (892460)

The INF card does not have a modem and does not accept external synchronization clocks. In all other respects, it is functionally identical to the INF-E and INF+M cards (see Figure 6-6).

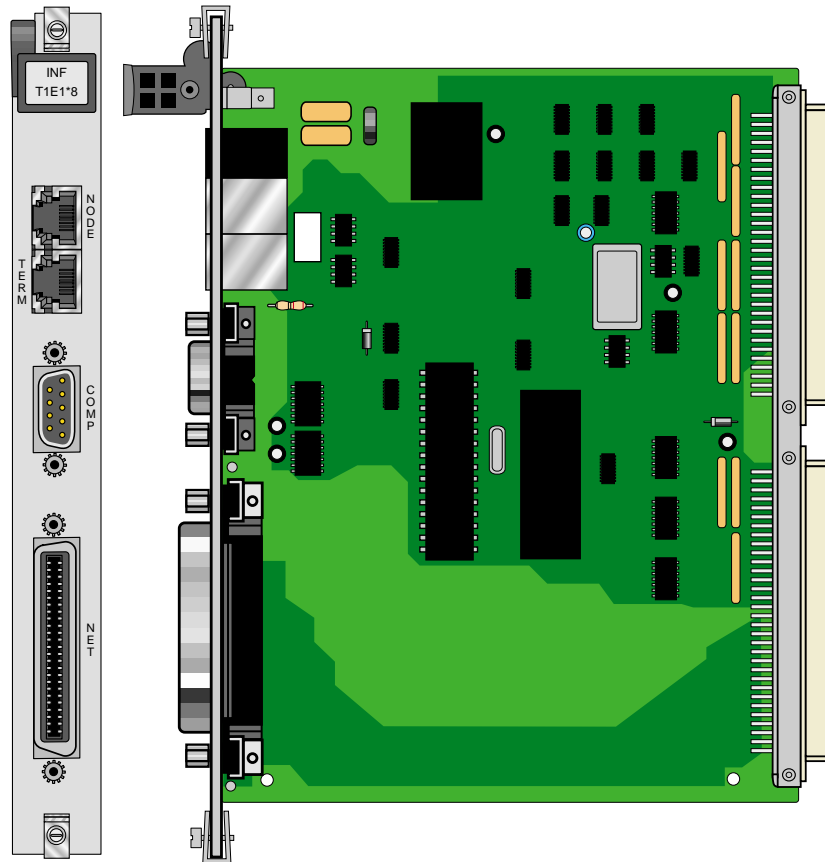

Figure 6-6. INF Interface Card (892460)

6.2.3.1 Card Jumper/Switch Settings

The INF card doesn't have any jumpers or switches on its mainboard.

6.2.3.2 Installing the INF Card

Install the INF card into the IF slot of the system chassis. Each system can have only one INF card.

6.3 Interface Card User Screens and Settings

6.3.1 Interface Card Main Screen

Figure 6-7 shows the Interface Card Main Screen. You must use this screen to define two timing sources for the card, and then go to other screens for additional setup and information viewing instructions. To go to the Interface Card Main Screen, highlight that card in the System Main Screen and press <Enter>.

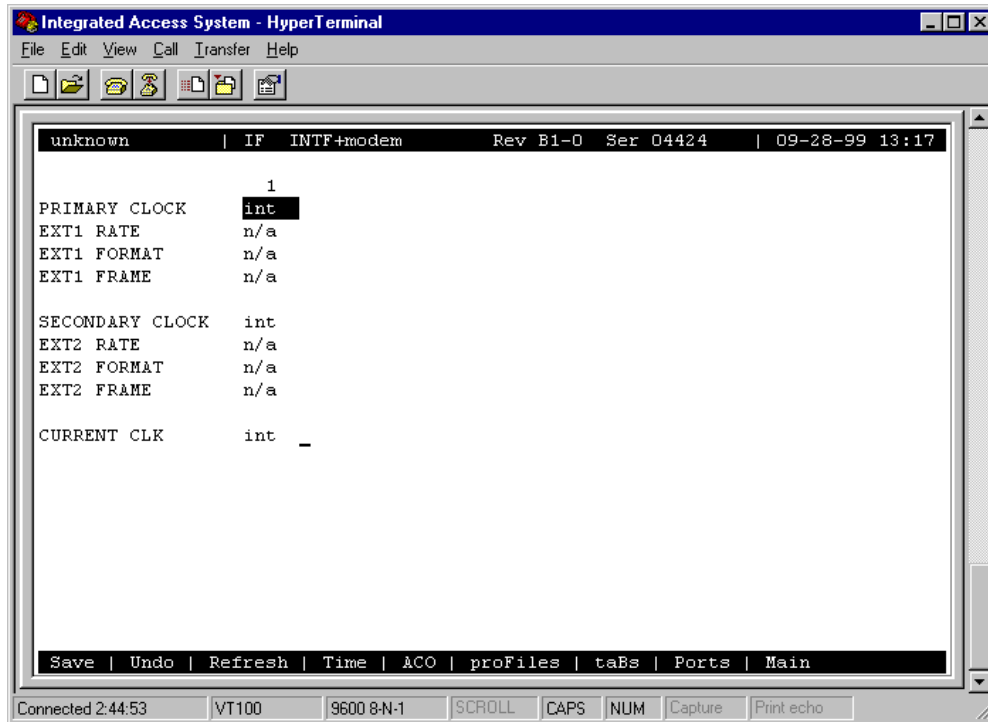

Figure 6-7. Typical Interface Card Main Screen

The bottom line of this screen shows numerous actions that you can perform from the screen. To perform an action, simply press the associated capital letter on your keyboard. For example, to save your option settings, press “s” (for **S**ave). Table 6-2 lists the available actions.

Table 6-2. Interface Card Main Screen Actions

Action	Function
Save	Saves changes to settings.
Undo	Returns all settings to the last saved state.
Refresh	Used to redraw the screen.
Time	Sets the system time and date. See the “Setting the System Date and Time” section later in this chapter.
ACO	Turns ACO alarm on and off.
proFiles	Profiles function inoperable with this release.
taBs	Signaling conversion tables for ABCD bits from ANSI to ITU-T for voice circuits.
Ports	Allows you to configure each Interface card port for operation. See the “Ports Screen” section later in this chapter.
Main	Returns to the Main screen. If changes are made to settings and not saved, you will be prompted to save or lose changes.

6.3.1.1 Setting the System Date and Time

To set the current date and time for the Integrated Access System, first press “**t**” in the Interface Card Main Screen to choose the **Time** action from the bottom line of that screen. The current date and time now appear in the lower left of the screen, in the format MM-DD-YY HH-MM. The **MM** field (month) is highlighted.

Use the up-arrow and down-arrow keys to set the current month (**01** to **12**, as required). Also move to each remaining field with the right-arrow and left-arrow keys, and select the current day (**DD**) and year (**YY**), and the current hour (**HH**) and minute (**MM**). The current time of day is displayed in 24-hour continuous format, where HH is **00** to **11** for a.m. and **12** to **23** for p.m.

When you finish setting these fields, press <Enter> and then press “**y**” to confirm that you want to save the changes. The system will subsequently stamp the current date and time on all alarm messages it reports.

6.3.1.2 Selecting the System Timing Clocks

Table 6-3 lists the Interface Card Main Screen configuration options, along with the possible and default values. In this screen, you must specify a primary and secondary timing source (clock) for the Integrated Access System. These settings are described in the following paragraphs.

Table 6-3. Interface Card Setting Options and Defaults

Parameter	User Options	Default
PRIMARY CLOCK	int serv(P1, P2, P3) wan(w1-1, w1-2, w2-1, w2-2, w3-1, w3-2, w4-1, w4-2) user(U1, U2, U3, U4, U5, U6, U7, U8)	int
EXT RATE	n/a	n/a
EXT FORMAT	n/a	n/a
EXT FRAME	n/a	n/a
SECONDARY CLK	int serv(P1, P2, P3) wan(w1-1, w1-2, w2-1, w2-2, w3-1, w3-2, w4-1, w4-2) user(U1, U2, U3, U4, U5, U6, U7, U8)	int
EXT RATE	n/a	n/a
EXT FORMAT	n/a	n/a
EXT FRAME	n/a	n/a
CURRENT CLK	cannot edit this field	---

PRIMARY CLOCK

The primary clock provides all internal timing for the system. You can select a network clock source or the system's internal crystal oscillator.

A network clock is the best Primary Clock source. To select this source, set the Primary Clock field to **wan**, and then specify the WAN link to which the clock source is connected (for example, **w1-1** for T1 or E1 link 1 on the WAN card in chassis slot W1). The WAN clock source will be either 1.544 or 2.048 Mbps (T1 or E1 link). This clock must be accurate to within ± 50 parts per million (50×10^{-6}).

Select **int** to have the system generate a clock from its own internal crystal oscillator. The stability of this Stratum 4 clock is ± 25 parts per million (25×10^{-6}). If you use the system's internal crystal oscillator as a clock source, all other devices attached to the network should also derive their timing from it.

Select **serv** to use a primary clock derived from an ATM server card in the system. If you choose this setting, also specify the associated card slot (**P1, P2, or P3**). If you select a slot that contains any other type of server card, the message **CARD CANNOT BE SELECTED** appears.

Select **user** for a primary clock from a BRI card in the system. If you select **user**, also specify the chassis slot location of the desired card (**U1 to U8**), followed by the card port from which the clock will be provided (**u1-1 through u8-8**) as required. If you select a chassis slot that contains any other type of user card, the message **CARD CANNOT BE SELECTED** appears.

If your system has an INF-E card, AND if external synchronization clocks are connected to its SYNC jack, select either **ext1** or **ext2**. The options **ext1** and **ext2** are used when the primary clock is derived from an external timing source.

External timing sources are provided by the user and are connected through the wire-wrap terminals of the external timing sync panel (see Figure 6-4). This panel allows for up to two external timing sources to be connected to the system. Refer to **EXT FORMAT** below for more information on external source clocking.

EXT RATE

Set this option for the primary clock to **t1** for a 1.544 Mbps WAN clock, or to **e1** for a 2.048 Mbps WAN clock. If all WAN links in a system are either T1 or E1, this option should automatically default to the correct rate.

EXT FORMAT

If **EXT RATE** is **t1**, set this option to **esf** or **d4**, as required by the T1 link. This option does not appear if the Line Rate is **e1**.

EXT FRAME

If **EXT RATE** is **e1**, set this option to **erc** or **d-frm**, as required by the E1 link. This option does not appear if the Line Rate is **t1**.

SECONDARY CLOCK

If the Primary Clock signal fails, the system automatically switches to an operator-defined Secondary Clock source. In the event of a failure to the Primary Clock Source, once it is fixed it will automatically restart. The secondary clock source may be a different WAN link, server, user card, or external source, or it can be the system's internal crystal oscillator. Although a secondary clock source is not required for system operation, you should always provide one for the system.

EXT RATE

Set this option for the primary clock to **t1** for a 1.544 Mbps WAN clock, or to **e1** for a 2.048 Mbps WAN clock. If all WAN links in a system are either T1 or E1, this option should automatically default to the correct rate.

EXT FORMAT

If EXT RATE is **t1**, set this option to **esf** or **d4**, as required by the T1 link. This option does not appear if the Line Rate is **e1**.

EXT FRAME

If EXT RATE is **e1**, set this option to **erc** or **d-frm**, as required by the E1 link. This option does not appear if the Line Rate is **t1**.

CURRENT CLK

The Current Clock field shows the primary or secondary clock now in operation. You cannot edit this field.



***Note:** Jumper positions will affect the available choices.*

6.3.2 Call Profile Screen

To enter a new call profile, first press “F” in the Interface Card Main Screen (**proFiles** command). Then, type **01** for the first new profile to be created. This brings up the Call Profile Screen shown in Figure 6-8.

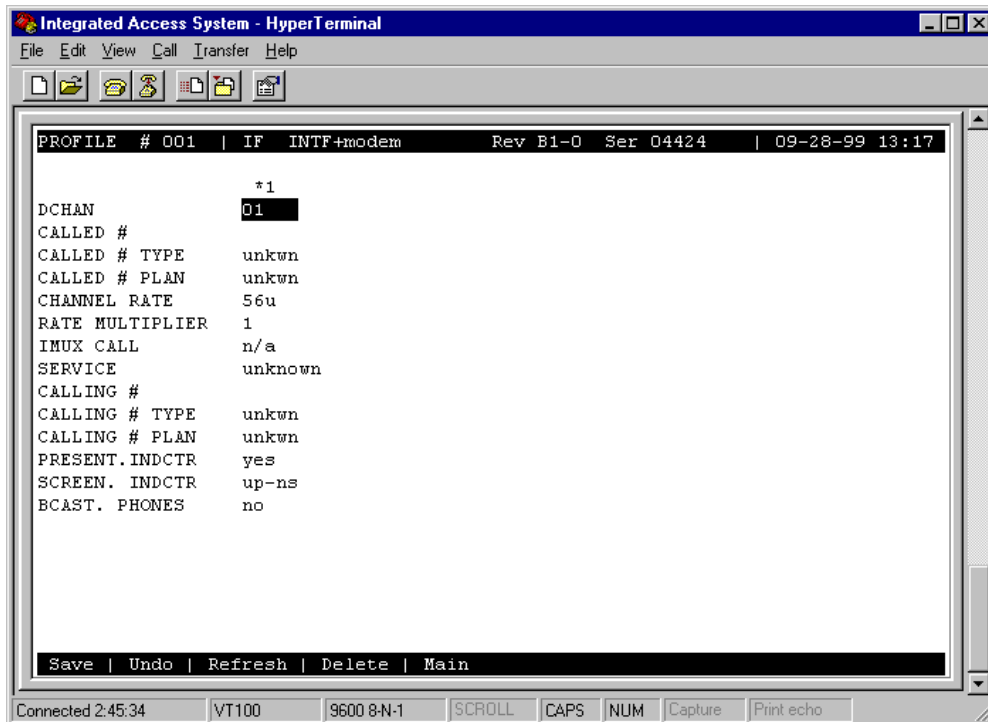

Figure 6-8. Typical Call Profile Screen

In the current system software version, you can program up to six call profiles.

Since leading zeros are ignored, the entries **001**, **01**, and **1** all refer to the same call profile. If the call profile does not already exist, the system will ask if you want to create it now.

Table 6-4 lists the actions you can perform from the Call Profile Screen. Table 6-5 shows the settings and defaults for each parameter.

Table 6-4. Call Profile Screen Actions

Action	Function
Save	Saves changes to settings.
Undo	Returns all settings to the last saved state.
Refresh	Used to redraw the screen.
Delete	Deletes the call profile on the screen. You are prompted with yes/no question prior to deletion.
Main	Returns to the Interface Card Main Screen. If changes are made to settings and not saved, you will be prompted to save or lose changes.

Table 6-5. Call Profile Screen Options and Defaults

Parameter	User Options	Default
DCHAN	01-08	01
CALLED #	telephone number (25 numeric characters)	blank
CALLED # TYPE	natnl intl sbscr unkwn	unkwn
CALLED # PLAN	unkwn isdn phone print	
CHANNEL RATE	56u 56r 64u 64r 384u 384r 1536u 1536r MRate	56u
RATE MULTIPLIER	1, 6, 24, or 2 to 30	1
IMUX CALL	n/a	n/a
SERVICE	service from list set on ISDN card for this D channel (first 7 characters)	blank
CALLING #	telephone number (25 numeric characters)	blank
CALLING # TYPE	natnl intl sbscr unkwn	unkwn
CALLING # PLAN	unkwn isdn phone print	unkwn
PRESENT. INDCTR	yes no	yes
SCREEN. INDCTR	reserved for future use	up-ns
BCAST. PHONES	no yes	no

Notes:

1. The Rate Multiplier is as follows:

1 if the Channel Rate is **56u**, **56r**, **64u**, or **64r**.

6 if the Rate is **384u** or **384r**.

24 if the Rate is **1536u** or **1536r**.

From **2** to **30** if the Rate is **MRate**.

DCHAN

The D-Channel number identifies which D-channel to route all outgoing calls that use this call profile. The options are numbers **1** to **8**.

CALLED

The Called Number is the full telephone number of the device you are calling. Up to 25 numeric characters are allowed, although most calls use only ten digits. This parameter can be overridden on a call-by-call basis when RS-366 or V.25bis dialing is used with the 8213 HSU Card.

CALLED # TYPE

The Called Number Type identifies the type of network used to reach the called phone number. The options are **natnl** for domestic calls, **intl** for international calls, **sbscr** for Virtual Private Network (VPN) calls, and **unkwn** (default). Your carrier will provide more detail about this option.

CALLED # PLAN

The Called Number Plan refers to the type of numbering plan used to reach the device you are calling. The options are **unkwn**, **isdn**, **phone** and **privt**. Your carrier will provide more detail about this option.

CHANNEL RATE

The Channel Rate selection specifies the bandwidth to be used by the call. Different carriers support different rates, so it is important to check with your carrier before setting rates greater than 64 kbps. When using any Channel Rate other than **MRate**, the system knows the size of the bandwidth required and will automatically select the rate multiplier. If **MRate** is selected, the user must enter the rate multiplier.

The “**u**” and “**r**” in these selections identify unrestricted and restricted data calls. An **unrestricted** call means that you can send any type of data information in the circuit. A **restricted** call means that you must maintain the ones-density-integrity of the T1 data stream.



*Note: Channel Rates of **1536r** and **1536u** require the use of NFAS.*

RATE MULTIPLIER

The Rate Multiplier setting depends on the Channel Rate chosen in the previous paragraph. If the Channel Rate is set to **MRate**, the Rate Multiplier can be from **2** to **30**. If an incorrect rate multiplier is input, the carrier equipment will reject the call.

IMUX CALL

The IMUX Call field has no application on this screen and will always show as **n/a**. This field is only activated when downloaded to the HSU card and used to designate an IMUX call. For more information, please review the HSU card chapter.

SERVICE

The Service parameter is entered only if call-by-call service selection is supported on the D channel selected in the DCHAN parameter above. If call-by-call service selection is provisioned on the selected D channel, the user must enter a valid service code in this field. Valid service codes are those that were entered for this D channel in the Services subscreen of the D channel configuration screen.

To change this selection, highlight the selection with the cursor and press the “Enter” key. A list of all service options for this D channel will appear at the bottom of the screen. Move the cursor to the appropriate selection using the right and left arrow keys and press the “Enter” key again when the correct choice is highlighted.

CALLING

The Calling Number is the phone number of the calling party that is presented to the called party when the incoming call is delivered. This feature is known as Automatic Number Identification (ANI).

If you want the main (billing) number to be presented to the called party, this field must contain a number of up to 25 digits. If you want the specific phone number of the HSU port making the call to be presented, leave this field blank.

CALLING # TYPE

The Calling Number Type identifies the type of network used by the calling party. The options are **natnl** for domestic calls, **intl** for international calls, **sbsr** for Virtual Private Network (VPN) calls, and **unkwn** (default). Your carrier will provide more detail about this option.

CALLING # PLAN

The Calling Number Plan refers to the type of numbering plan used by the calling party. The options are **unkwn**, **isdn**, **phone** and **privt**. Your carrier will provide more detail about this option.

PRESENT. INDCTR

The Present Indicator field determines whether or not the calling number may be displayed to the called party. The options are **yes** and **no**.

SCREEN. INDCTR

The Screen Indicator field is reserved for future use.

BCAST. PHONES

The Broadcast Phones parameter works with the HSU Call Profile to provide simultaneous one-way calls.

6.3.3 Signaling Conversion Table Screen

Signaling conversion is required when cross-connecting a T1 (ANSI) voice circuit to E1 (ITU-T). This process translates the sequences of the ABCD signaling bits to allow proper signaling between the two carrier types.

You can set up signaling conversion for all types of voice circuits from the Signaling Conversion Table Screen, which is shown in Figure 6-9. To go to that screen, press “b” in the Interface Card Main Screen (taBs command).

You can accept the default bit pattern changes, or you can set a different ABCD signaling bit pattern and insert it in the table. Each voice circuit type is represented by two columns that correspond to ITU-T to ANSI conversion (C->A) and ANSI to ITU-T (A->C) conversion.

ABCD	E&M		FXS/FXSC		FXO/FXOC		PLAR	
	C->A	A->C	C->A	A->C	C->A	A->C	C->A	A->C
0000	0000	1101	0101	0101	0101	0101	1111	0101
0001	0000	1101	0101	0101	0101	0101	1111	0101
0010	0000	1101	0101	1101	0101	1101	1111	1101
0011	0000	1101	0101	1101	0101	1101	1111	1101
0100	0000	1101	0101	1101	0101	1101	1111	1101
0101	1111	1101	0000	1101	1111	1101	0000	1101
0110	0000	1101	0101	1101	0101	1101	1111	1101
0111	0000	1101	0101	1101	0101	1101	1111	1101
1000	0000	1101	0101	1101	0101	1101	1111	1101
1001	0000	1101	0101	0101	0101	1101	1111	1101
1010	0000	1101	0101	0101	0101	1101	1111	1101
1011	0000	1101	0101	1101	0101	1101	1111	1101
1100	0000	1101	0101	1101	0101	1101	1111	1101
1101	0000	0101	0101	0101	0101	1101	1111	1101
1110	0000	1101	0101	1101	0101	1101	1111	1101
1111	0000	0101	0101	0101	0101	1101	1111	1101

Enter conv. bits: 0000

Save | Undo | Refresh | Default | Main

Figure 6-9. Signaling Conversion Table Screen

For example, an E&M circuit in the “0101” state (shown in the far-left ABCD column of the screen) will send **0101** as the ABCD bits from the ITU-T end of the circuit. The ANSI end will receive and convert those bits to **1111**. In the opposite direction, the signaling bit sequence will be sent as **1111** from the ANSI end and converted to **0101** at the ITU-T end. However, you can manually override the received ABCD bit pattern at either end.

The E&M portion of the Signaling Conversion Table Screen is also used for FXSDN, FXODN, PLAR-D3, DPO, and DPT signaling. The FXS/FXSC portion is used for FXO-to-FXS signaling, and the FXO/FXOC portion is used for FXS-to-FXO signaling. The PLAR portion is used for PLAR-D4 to PLAR and MRD.

Table 6-6 lists the actions you can perform from the Signaling Conversion Table Screen. These actions appear in the bottom highlighted line of the screen.

Table 6-6. Signaling Conversion Table Screen Actions

Action	Function
Save	Saves changes to settings.
Undo	Returns all settings to the last saved state.
Refresh	Redraws the current screen.
Default	Returns column to default settings, one column at a time. You must save your changes after using this command.
Main	Returns to the Interface Card Main Screen. If changes are made to settings and not saved, your changes will be lost.

6.3.4 Remote IMACS Terminal System (RITS)

The Remote IMACS Terminal System (RITS) is a special application for users using microwave transmission. Using communication software, a user can log into a number of different systems from a single control station (PC, MAC, Sun, or HP Workstation) to download alarm information, change card settings, and perform maintenance.

Systems are connected from the Interface card's COM port to a wireless control network through the RS232 input on one of the four service channels on the wireless network. The Control Station (PC) is connected to pin #2 out and #3 in. Each of the integrated access controllers is connected to RS232 pin #2 in and pin #3 out.

The actual number of the systems that can be connected together is determined by the amount of different numbers that can fit in the "SYS PH#" field in the CPU submenu. The CPU submenu is accessed by selecting a CPU through the user interface and pressing the <ENTER> key.

6.3.4.1 Identification

Each system has a unique identification number on the integrated access controller network (phone number). The unique identification number is used to determine which Controller can be accessed remotely on a serial line. The identification number for each console needs to be entered in the "SYS PH#" field in the CPU submenu. No two systems can have the same number in the "SYS PH#" on the same network. If that field is the same on more than one integrated access controller, race conditions will occur. Therefore each console on a single network must have an individual number in the "SYS PH#" field.

The identification numbers for the integrated access controllers cannot be entered through a control station. This safeguard is provided to ensure a reliable connection between a control station and an integrated access controller. Attempts to change an identification number of a system remotely will be denied.

6.3.4.2 Network Priorities

All integrated access controllers on the wireless network have equal priorities. Because of this equality, no Controller can interrupt a remote session between another Controller and a control station. This is why the control station always initiates all communication on the RITS network.

6.3.4.3 Intra-Network Communications

Integrated access controllers cannot communicate with each other. Communication on the network is only between the control station and a single Controller. Since the communications on the network of integrated access controllers is always initiated by the control station, the Controller systems cannot communicate with each other. Figure 6-10 shows a diagram of three RITS units.

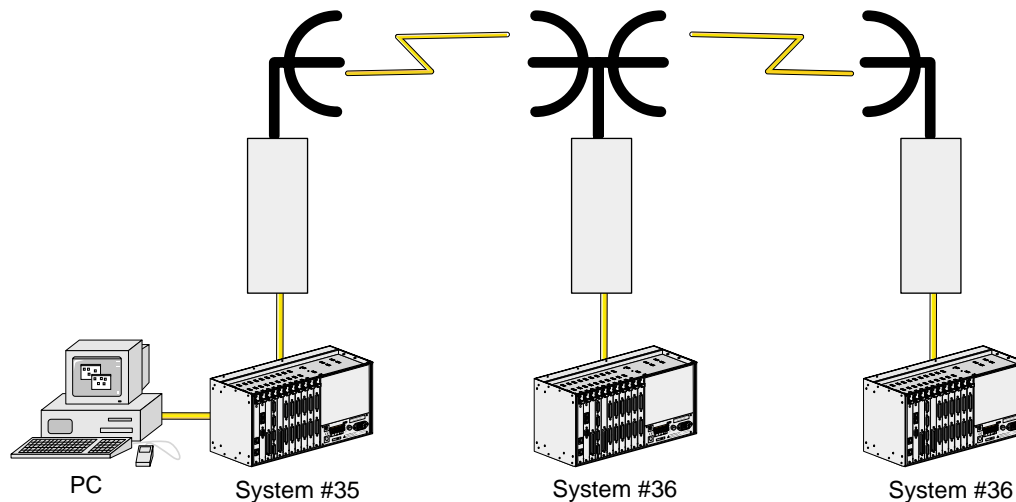

Figure 6-10. Typical RITS Configuration

The PC associated with integrated access controller #34 can engage any of the two other units by using “AT” commands from the communications software used. If a local VT-100 is active at any of the remote locations, the user will be logged off and the master PC will control the system unit. When the master PC logs off, the local user will be able to log into the unit again. Connections at all units are done through the DB9 computer port.

6.3.4.4 Terminal Security

No user may log into any integrated access controller on the network without knowing the individual password of each system.

Table 6-7 list the “AT” commands and the associated function. All “AT” commands are followed by pressing the <ENTER> key.

Table 6-7. “AT” Commands Used by RITS

AT Command	Function
ATDTxxx	Establish a user interface connection.
ATDTxxxR	Establish an alarm reporting connection. (Connection only lasts for the length of time necessary to upload and display all alarms that are being reported by the system that have not yet been displayed.)
ATDTxxxC	Establish a current alarm reporting connection. (Connection only lasts for the length of time necessary to upload and display all active alarms that are being reported by the system.)
ATDTxxxH	Establish a historical alarm reporting connection. (Connection only lasts for the length of time necessary to upload and display the alarm history reported by the system.)
ATDTxxxCH	Establish a current and historical alarm reporting connection. (Connection only lasts for the length of time necessary to upload and display the current alarms and alarm history reported by the system.)
+++	Disconnects a remote session.
“L” (letter L)	Disconnects a remote session.
xxx indicates the phone number on the CPU card of the desired system unit.	

6.3.5 Ports Screen

You also must configure each of the Interface card's user interface ports. This is done from the Ports Screen, which is shown in Figure 6-11. To go to this screen, press "p" in the Interface Card Main Screen (**P**orts command).

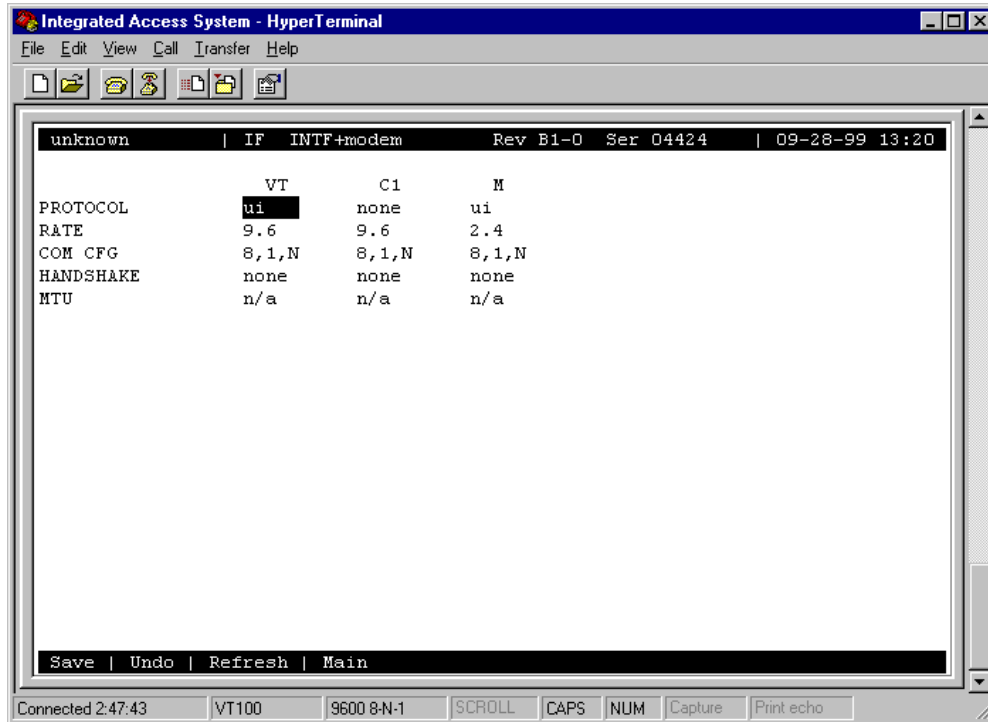

Figure 6-11. Typical Ports Screen (INTF+M)

This screen shows the Protocol, Rate, Communications, and Handshaking control settings for each port. The VT column lists the current settings for a VT100-compatible terminal connected to the TERM modular jack on the Interface card faceplate. The C1 column is for an external computer connection to the COMP (or COM1) DB-9 plug on the card. The M column is for a modem connection from an INF+M card to a remote facility via a phone line.

The screen settings are described in the following paragraphs.



Note: *There are two scenarios in Figure 6-11. The Typical INTF+M Ports Screen shown above displays (VT - VT100 terminal, C1 - COM1, and M-Modem). However, if INTF+E is used the screen will display (VT, C1, and C2 - COM2).*

PROTOCOL

For the VT-100 terminal port (**VT**), the Protocol setting is always **ui** (user interface).

For the computer (**C1**) port, choose **none**, **ui** (user interface), **pr** (printer), **slip** (Serial Line Interface Protocol), or **ppp** (Point-to-Point Protocol).

For the modem port, choose **ui**, **ui-pr**, or **none**.

RATE

The transmission rate for the VT is **9.6** kbps when selecting protocol setting **ui**. The transmission rates for C1 port when selecting protocol setting **ui** are: **0.3, 1.2, 2.4, 4.8, 9.6** or **19.2** kbps, **9.6** kbps for protocol setting **pr**, **9.6** kbps for protocol setting **slip** and **19.2** kbps for protocol setting **ppp**. The transmission rate for the M port is 2.4 kbps for protocol settings **none**, **ui** and **ui-pr**.

COM CFG

The Communication Configuration settings are always 8 data bits, one stop bit, and no parity (**8,1,N**) for all three ports. You cannot change these settings on any port.

HANDSHAKE

The Handshaking setting is always **none** for all three ports. You cannot change these settings on any port.

MTU

The Maximum Transmission Unit settings are **128 - 1500** when selecting protocol **slip** and **ppp** in the C1 port. The default is **240**.

6.3.6 Interface Card Ports and Functionality

The Interface card controls many critical functions in the system. It provides interfaces to external control devices, terminates all T1 and E1 WAN links, and holds the nonvolatile RAM and the internal modem. Table 6-8 lists the interface ports and functions. Figure 6-12 shows the component layout and labels the ports.

Table 6-8. Interface Ports and Functions

Interface Ports	Function
Modem	Connects the internal modem to a phone line.
Node	Provides contacts to report ACO alarms
Control Terminal	Connects the system to a VT-100 compatible terminal.
Computer	Connects a local device for printing alarms; or to NMS.
T1/E1 WAN link	Connects the system to T1 and E1 lines.

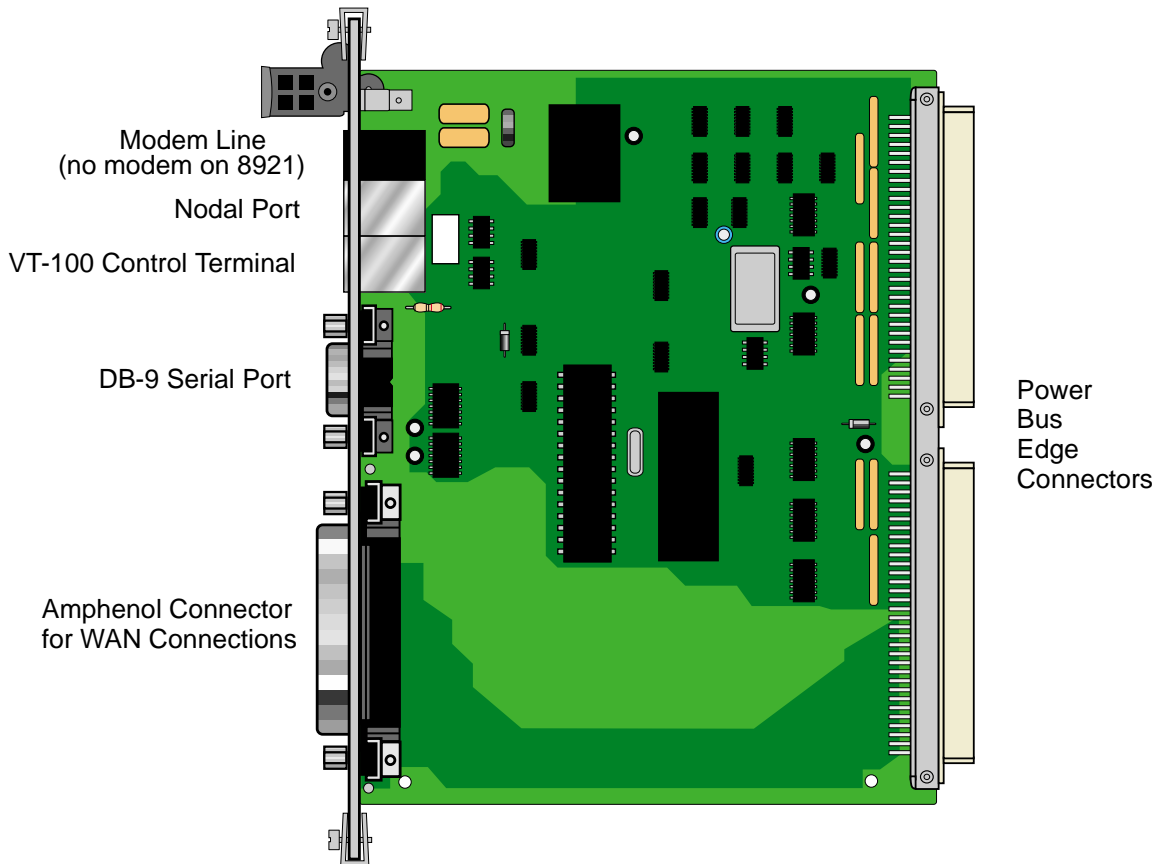

Figure 6-12. Component Layout for the INF+M T1E1*8 and INF T1E1*8 Interface Card

6.3.7 Using the Node Port

The Node Port allows the system to report ACO (Alarm Cutoff) alarms to an external system to alert the operator to critical situations. Using the ACO function keeps the alarm active until manually cleared from the terminal.

The node port uses an RJ48 connector. Pins 3, 4, and 5 uses an RS485 compatible form c-contact closure that can be used to report ACO alarms to an external system. Pins 1, 2, 6 and 7 are reserved for future use. Pin 8 is ground.

Connection of the ACO alarm interface to an external alarm device (such as a buzzer or light) alerts you to problems with the system. Figure 6-13 shows a possible configuration connecting a unit to a generic external alarm system. The nominal input is 5V and the short-circuit current is 250mA.

The alarm interface is activated by the ACO setting. This will activate the device when a designated alarm occurs.

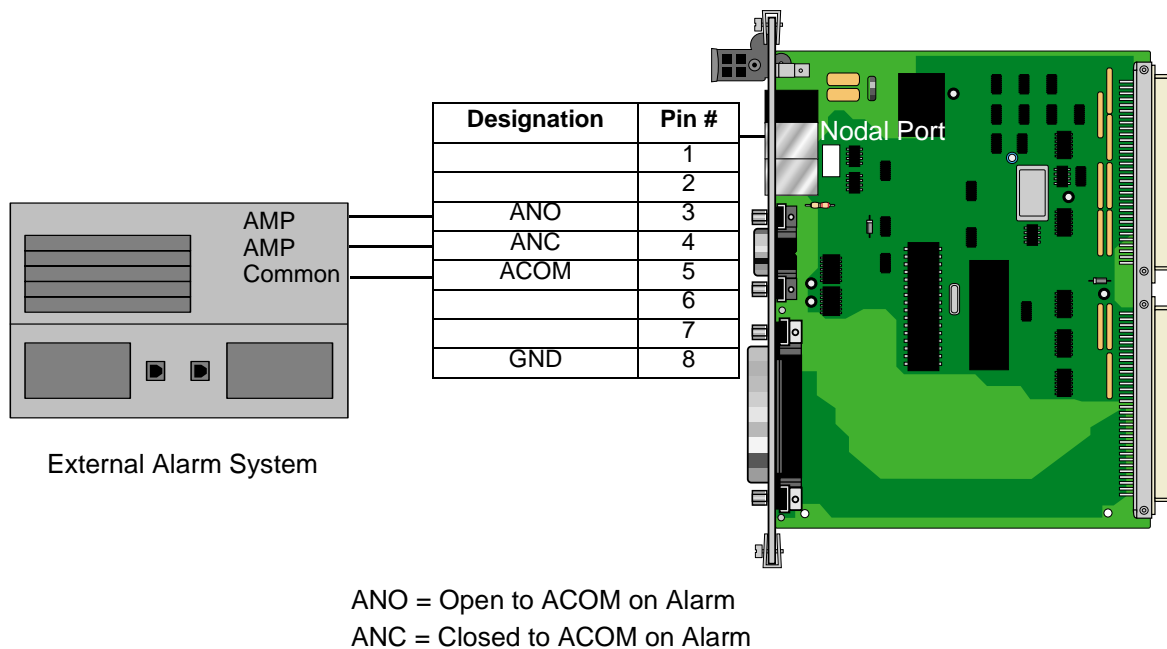

Figure 6-13. Node Port ACO Alarm Interface

6.4 Interface Card Error Messages

Refer to Appendix B in the System Reference Guide for further information on Error Messages regarding this card.

6.5 Interface Card Troubleshooting

6.5.1 User Interface Problems

The Interface card provides the connections from the Integrated Access System to the external control terminals and/or other network management systems. This card may be faulty if you are connected to the system but receive no responses to your commands. However, the problem in this case also may be with the 8803 CPU Card.

First, check the cabling connections from the Interface card to the appropriate external device. Refer to the “Interface Card Description” section at the beginning of this chapter for more information on the card faceplate jacks and signal connections. If possible, substitute a known good cable for the one you suspect is faulty.

If the cable connection is good, unplug the CPU card from the system chassis and then plug it back in to restart the CPU and system. (The problem may have been a momentary system “freeze”.) Then, log into the system again and repeat the command (or series of commands) that initially caused the problem. If the problem continues, replace the Interface card with an identical new card.



Note: *Removal of the Interface card will cause a service disruption on all T1 and E1 WAN links of the system.*

If the problem persists with the new Interface card, the CPU card is probably faulty.

If the Interface card is determined to be faulty, replace it and return the faulty unit for repair to the location specified by your distributor.

6.5.2 Alarm Reporting Problems

The Interface card also provides a relay contact closure to an external alarm annunciation (or other alarm reporting device at the system site) when an alarm is declared. The card may be faulty if an alarm is declared but not indicated on the external alarm reporting system. Check the wiring from the Interface card NODE port to the alarm system. If the wiring is good, replace the Interface card.



Note: *Removal of the Interface card will cause a service disruption on all T1 and E1 WAN links of the system.*

6.5.3 WAN Transmission Problems

A faulty Interface card could cause T1 and E1 WAN service disruptions, since this card also provides the WAN connections. Electrically, the Interface card resides between the WAN cards and the T1/E1 network. If all T1 and E1 links are down (as evidenced by system alarms in progress), first check the cable from the WAN jack of the Interface card to the network. If the cable connection is good, replace the Interface card.



Note: *Removal of the Interface card will cause a service disruption on all T1 and E1 WAN links of the system.*

If the problem is with only one T1 or E1 WAN link, refer to the WAN Chapter in this manual and troubleshoot that link and its associated WAN card. Use the loopbacks provided in the WAN card user interface screens in conjunction with the built-in test patterns you can apply from the Integrated Access System. These test functions allow you to isolate the problem to the local or far (remote) end. You can then check the interconnect cabling from the Interface card to that link, and sequentially replace the WAN and/or Interface card, one by one, until the trouble clears.

6.6 Interface Card Specifications

Interface Cards (Models 892260, 892261, 892360 and 892460)

Models 892260, 892261, 892360 and 892460 128K NVRAM

Interfaces

Model	T1/E1 Links	Computer Port	Control Terminal Interface Port	Node Port	Internal Modem	External Sync
892260	8 T1/E1	yes	yes	yes	no	yes
892261	8 T1/E1	yes	yes	yes	no	yes
892360	8 T1/E1	yes	yes	yes	yes	no
892460	8 T1/E1	yes	yes	yes	no	no

WAN Ports

Electrical Interface G.703 or DSX-1

Connectors

Model 892220, 892261, 892360 and 892460 One Female 50-pin RJ27X telco connector

Computer Port Connectors

All Models prior to Rev C0 DB9F DCE (requires 1201 cable)
 All Models from Rev C0 DB9M DTE (requires 1202 cable)
 Electrical Interface RS-232, ITU-T V.28
 Function Connects to local Element Management System
 Code Set 8 bit characters plus one start and one stop bit with no parity
 Max Speed 19.2 Kbps (PPP) or 9.6 Kbps (SLIP)

Control Terminal Interface Port

Connector RJ-48 Female, 8-pin, EIA 561
 Electrical Interface DCE RS232, ITU-T V.28
 Function Connect local VT100-compatible Control Terminal local craft interface
 Code Set 8 bit characters plus one start and one stop bit with no parity
 Speed Maximum 9,600 bps asynchronous

Nodal Port

Connector RJ-48 Female, 8-pin
 Electrical Interface Dry contact
 Alarm Output Passive current loop, one normally open loop and one normally closed loop.
 Function Alarm management between co-located Integrated Access System nodes and external alarm management systems and panels.

Modem Port (Model 892360 only)

Connector	Female 6-pin RJ-11C socket
Electrical Interface	600 ohm 2-wire balanced
Protection	HV zener, 0.25A fuses on Tip and Ring
Function	Connect internal modem to PSTN (Public Switched Telephone Network) for access to remote operator and remote EMS network management system.

Modem Specifications (Model 892360 only)

Compatibility	ITU-T V.22 bis
Modulation	16 point QAM
Line Interface	2-wire balanced 600 ohm
Ringer Equivalence	0.2A
Approval	FCC Part 68
Equalization	Receive automatic adaptive transmit fixed compromise
Transmit Level	-9.5 dBm
Receiver sensitivity	ON to OFF threshold -45 dBm OFF to ON threshold -48 dBm
Dialing Mode	DTMF Tone
Speed supported	2,400 bps asynchronous
Code set	8 bit characters plus one start and one stop bit with no parity

Adapters

Model 1106 with 2 BNC connectors	Supports 1 E1 circuit on 75 Ohms coaxial cable (RG59)
Model 1121 with 2 RJ48 sockets	Supports 2 T1 or E1 circuits on twisted pair cable plus bantam jacks for test access.
Model 1181 with 8 RJ48 sockets	Supports 8 T1 or E1 circuits on twisted pair cable
Model 118320 with 16 BNC sockets	Supports 8 E1 circuits (For 891630 Chassis)
Model 1184 with 16 BNC sockets	Supports 8 E1 circuits (For 891830 Chassis)

Standards Compatibility

ITU-T	V.28	Electrical characters for unbalanced double-current interchange circuits.
	V.22 bis	2400 bits per second Duplex Modem Using The Frequency Division Technique
EIA	G.703	Physical/Electrical Characters of Hierarchical Digital I/F
	561	8 Position Non-Synchronous Interface between DTE and DCE Employing Serial Data Interchange
Bellcore CEN	RS232-C	Interface Between DTE and DCE Employing Serial Binary Data
	GR-63-CORE Issue 1	Network Equipment-Building System (NEBS)
	EN 50 081-1	Electromagnetic compatibility generic emission standard Part 1 Residential, commercial and light industry
	EN 50 082-1	Electromagnetic compatibility generic immunity standard Part 1 Residential, commercial and light industry
	EN 60 950/A2	Safety of information technology equipment including electrical business equipment
FCC	Part 68 Subpart B	Requirements for Connection of Terminal Equipment Systems and Protective Apparatus to the Telephone Network
UL	1459	UL Standard for Safety of Telephone Equipment
	1950	UL Standard for Safety of Information Technology Equipment
CSA	C22.2 No. 950	Safety of information technology equipment including electrical business equipment

Chapter 7

WAN Card

7.1 Introduction

This chapter provides installation, configuration, and troubleshooting information for the Wide-Area Network (WAN) Cards. These include the WAN SINGLE (800060), WAN DUAL (801060), WAN-U DUAL (801160), WAN-R DUAL (801460), WAN ESF LPBK (801560) and WAN HDSL (802060) Cards. These designations are marked on the faceplate ejectors of the associated cards. Throughout the remainder of this chapter, these cards are referred to as the WAN SINGLE, WAN DUAL, WAN-U, WAN-R, WAN ESF LPBK and WAN HDSL cards, respectively.

This chapter also provides similar information for the DSX/CEPT, CSU, Adtran E1/HDSL and PairGain T1/HDSL plug-in modules used with the WAN cards.

The WAN cards manage the flow of data through the Integrated Access System network. They terminate T1 and/or E1 lines and generate or receive network timing clocks. They also cross-connect DS0 time slots, to pass data through the system from one T1 or E1 line to another.

7.2 WAN Card Descriptions

7.2.1 WAN SINGLE Card Description (800060)

The WAN SINGLE card connects to a single T1 or E1 line. It has one port for a T1 DSX, T1 CSU, or CEPT E1 interface. The WAN SINGLE (800060) card works with DSX/CEPT module (81130) and CSU Module (81230) referred to later in this section.

7.2.1.1 Card Jumper/Switch Settings

The WAN SINGLE card does not have any jumpers or switches on its motherboard.

7.2.2 WAN DUAL Card Description (801060)

The WAN DUAL card connects to two T1 or E1 lines, or to one of each type. It works with only one DSX/CEPT or CSU plug-in module if the WAN port without either module remains in the standby state (see Figure 7-1). **However, a CGA-Red alarm will be generated for that port.** The WAN DUAL (801060) card works with DSX/CEPT module (81130) and CSU Module (81230) referred to later in this section.

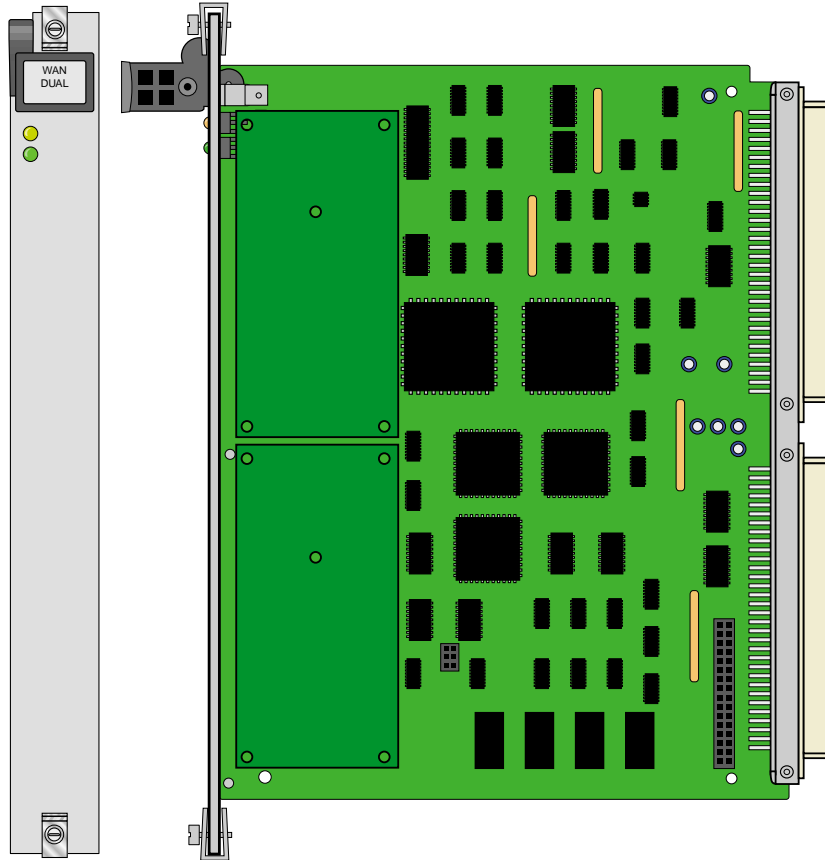

Figure 7-1. WAN DUAL Card (801060)

7.2.2.1 Card Jumper/Switch Settings

The WAN DUAL card does not have any jumpers or switches on its motherboard.

7.2.3 WAN-U Card Description (801160)

The WAN-U card is a dual-port card that provides HDSL 2.048 Mbps (E1) service when used with E1/HDSL plug-in modules (see Figure 7-2). **Only use the Adtran E1/HDSL module (820) with this card.**

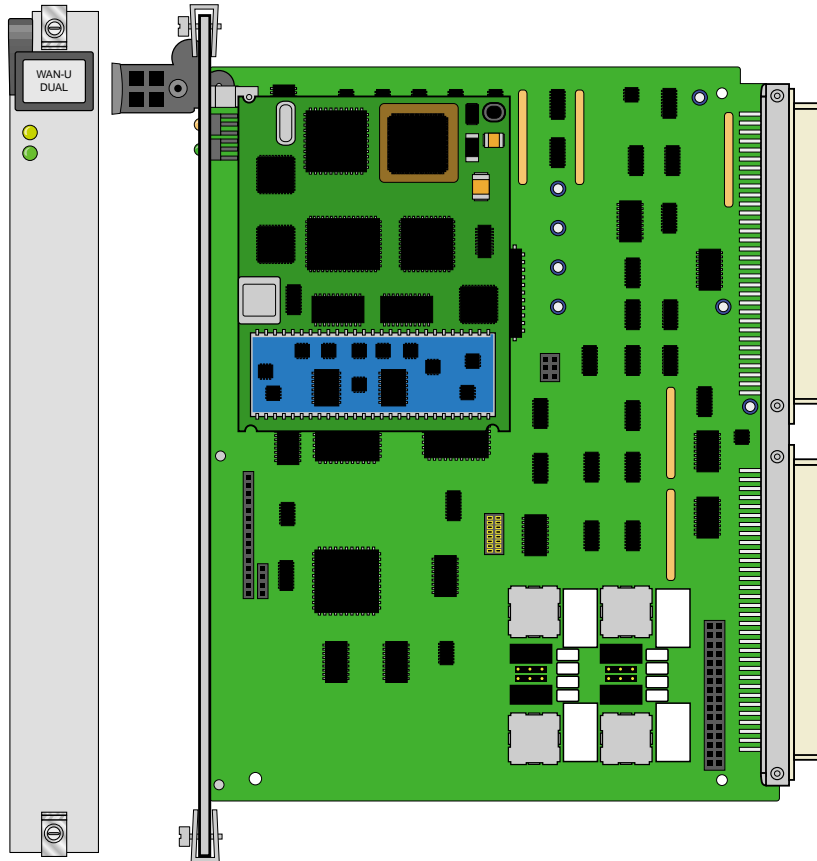

Figure 7-2. WAN-U DUAL Card (801160)

7.2.3.1 Card Jumper/Switch Settings

The WAN-U card does not have any jumpers or switches on its motherboard.

7.2.4 WAN-R Card Description (801460)

The WAN-R card is a dual-T1/E1 card with relays for use in CPU XCON systems with redundant WAN cards. When placed in slot W4 of a chassis, this card acts as a redundant (backup) card for up to three standard WAN cards in slots W1, W2, and W3. This arrangement is known as 1-in-N redundancy, where N is the number of working (primary) WAN cards

supported. If a working WAN card fails, the relay on the WAN-R card in slot W4 will switch its output to the correct pins on the WAN connector of the associated Interface card in the system. If the WAN-R card is placed in any other chassis slot, it works like a regular WAN DUAL card. The WAN-R (801460) card works with CSU module (81230).

7.2.4.1 Card Jumper/Switch Settings

The WAN-R card does not have any jumpers or switches on its motherboard.

7.2.5 WAN Card with ESF Loopback Description (801560)

The WAN card with ESF Loopback is able to detect ESF data link codewords for line and payload, activate and deactivate commands. A minimum reception of 10 continuous command patterns by each channel is required to trigger the loopback detection process, and the performing of the command. Since all 8 channels (4 WAN cards) are processed by one processor on the CPU card, simultaneous detection on more than one channel requires more than 10 repetitions. *The ESF Loopback feature can be used only in a T1 environment.*

7.2.5.1 Card Jumper/Switch Settings

The WAN card with ESF Loopback does not have any jumpers or switches on its motherboard.

7.2.6 WAN HDSL Card Description (802060)

The WAN HDSL (802060) card supports two PairGain T1/HDSL modules (82100) per card. Each module may be configured as master or slave. There must be one master and one slave in the circuit. The unit designated as the master can be accessed to change system parameters and view T1/HDSL system performance history and current status.

The slave can only provide T1/HDSL system performance history and current status. The slave unit receives configuration parameters from the master unit at the other end of the loop. The configuration parameters include: Timeout for loopback, DS1 line code option (e.g. B8ZS (Bipolar Eight Zero Substitution) / AMI (Alternate Mark Inversion)) and DS1 framing format (e.g. SF (Super Frame) / ESF (Extended Super Frame)). *The WAN Card with PairGain T1/HDSL (802060) modules can only be used in a T1 environment.*



Note: *The WAN HDSL card doesn't support line powering, WAN HDSL card redundancy or TR08.*



Note: This T1/HDSL PairGain Module can not communicate with modules from other vendors.

7.3 WAN Module Descriptions

7.3.1 DSX/CEPT Module Description (81130)

The DSX/CEPT module supports either the T1 DSX or E1 CEPT mode. It mounts on the WAN SINGLE, WAN DUAL, and WAN-R cards. The CEPT function of the DSX/CEPT module is used for connection to a 2.048 Mbps E1 network. Jumper settings are provided on the module to select either DSX or CEPT operation. All WAN cards equipped with DSX/CEPT modules also act as the "remote terminal" termination points for the Subscriber Loop Carrier (SLC-96) facilities defined in Bellcore publication TR-TSY-000008, Issue 2, August 1987.

7.3.1.1 DSX/CEPT Module Jumper Settings

After installing the DSX/CEPT modules, set their jumpers for either DSX (T1) or CEPT (E1) operation. These jumpers are factory-set for DSX. To convert a module to CEPT, reset the jumpers as described below. The actual jumper locations will depend on which module version you have.

7.3.1.2 DSX/CEPT Module Installation

For DSX or CEPT operation, you must install one of these modules on the associated WAN card before inserting those cards into the system chassis. Figure 7-3 shows the locations of the DSX/CEPT modules on a WAN card. One module is required per WAN port. If your system has a T1 link (DSX) and an E1 link (CEPT), you will need two DSX/CEPT modules.

First, install a DSX/CEPT module in the slot reserved for WAN port 1-1. Insert the pins for TX into socket JP10 on the WAN card (see Figure 7-3), while also inserting the pins for RX in JP9 and the 24-pin end connector pins in JP6. Then, for a WAN DUAL card, install another DSX/CEPT module in the WAN port 1-2 location, and plug that module into JP13, JP14, and JP15.

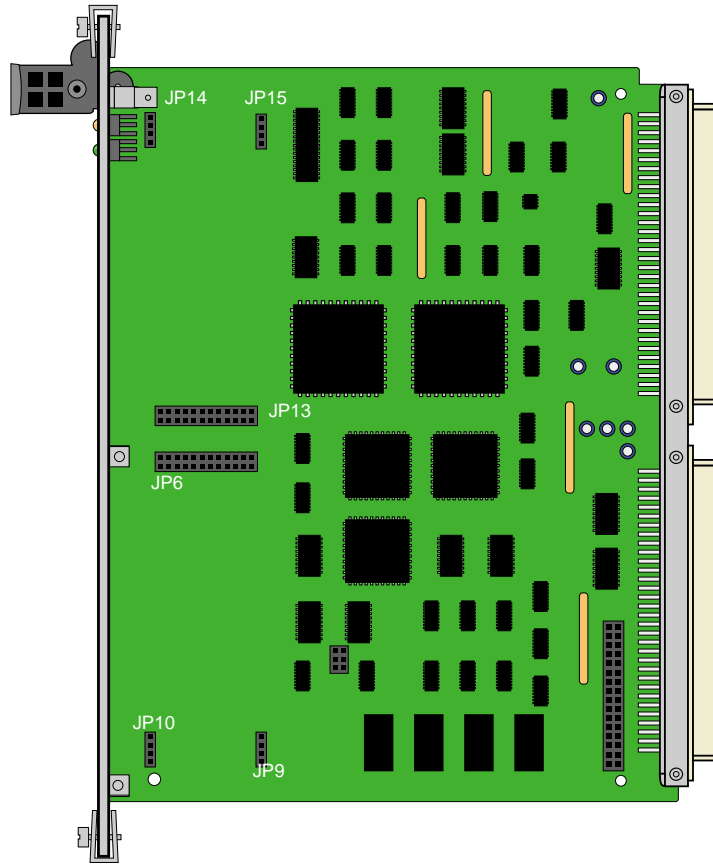

Figure 7-3. Installing DSX/CEPT Modules (8010)

7.3.1.3 DSX/CEPT Module

The DSX/CEPT Revision F module is shown in Figure 7-4 through Figure 7-6. These modules may be optioned for T1, 120-ohm balanced E1, or 75-ohm unbalanced E1. The jumper option configuration is shown on the card.

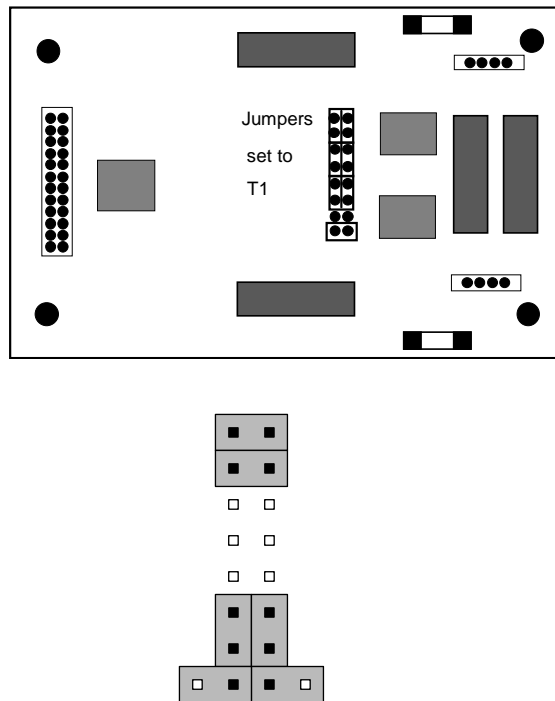

Figure 7-4. DSX/CEPT Module Jumpers (T1) (81130)

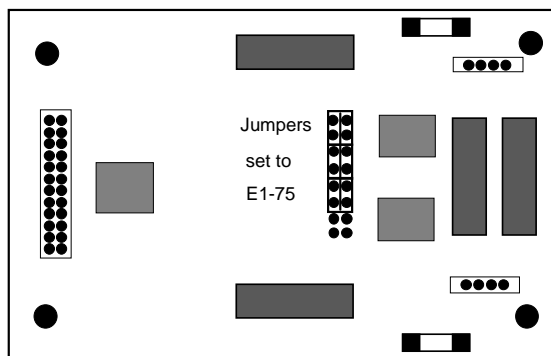

Figure 7-5. DSX/CEPT Module Jumpers (E1 75 Ohm) (81130)

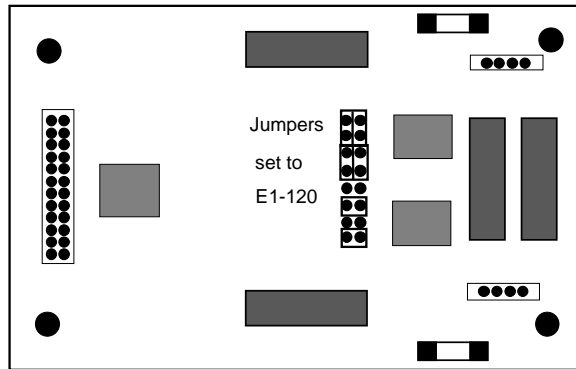

Figure 7-6. DSX/CEPT Module Jumpers (E1 120 Ohm) (81130)

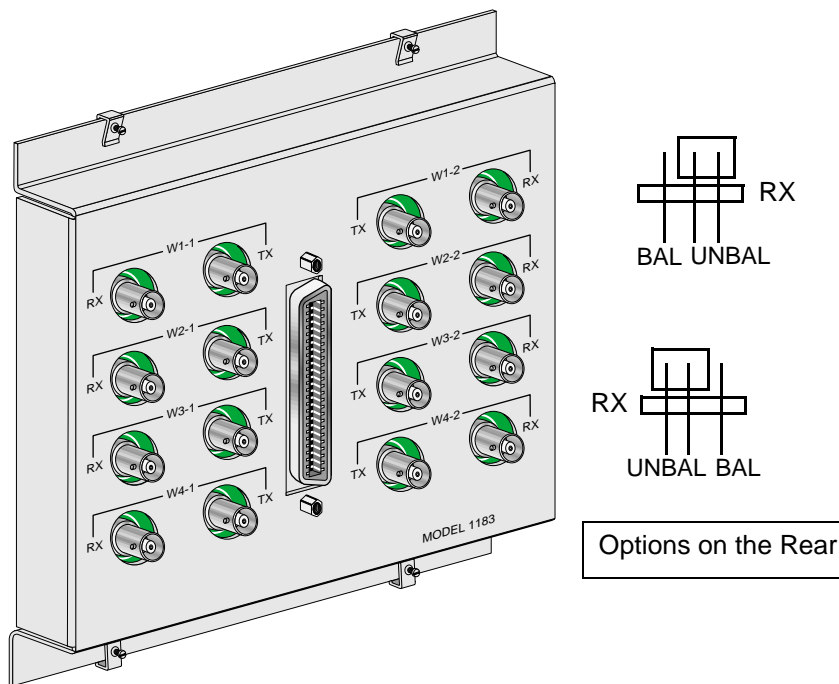

Figure 7-7. E1 Interface Adapter Panel (118320 or 1184)

For 120-ohm balanced E1 operation, set the jumpers on the adapter panel as shown in Figure 7-7. **Both** DSX/CEPT Modules should be set for balanced operation prior to installation.

For 75-ohm unbalanced E1, set the adapter panel jumpers to UNBAL **in one location only**, and set them to BAL in all other cases. When multiple DSX/CEPT modules with jumpers are installed, the unbalanced jumper should be set on the module closest to the E1 line. When the adapter panel is present, it is considered the unit closest to the E1 line. The corresponding jumpers on the rear of the panel are set to UNBAL while all other module jumpers are set to BAL.

7.3.2 CSU Module Description (81230)

The CSU module is required for Channel Service Unit (CSU) operation on a T1 line. This module mounts on the WAN SINGLE, WAN DUAL, and WAN-R cards, as shown in Figure 7-3. All WAN cards equipped with CSU modules also act as the "remote terminal" termination points for the Subscriber Loop Carrier (SLC-96) facilities defined in Bellcore publication TR-TSY-000008, Issue 2, August 1987.

7.3.2.1 CSU Module Installation

Install the CSU module on the associated WAN card by plugging its connector pins into the mating sockets of the WAN card, as shown in Figure 7-3. For a WAN DUAL or WAN-R card, you can install two modules.

7.3.2.2 CSU Module Jumper/Switch Settings

The CSU module does not have any jumpers or switches.

7.3.3 Adtran E1/HDSL Module Description (82030)

The Adtran E1/HDSL (High-bit-rate Digital Subscriber Line) provides transport for E1 rate (2.048 Mbps) or SDH rate (2.304 Mbps) data over copper exchange cable without circuit conditioning or mid-span repeaters. The Adtran E1/HDSL module can be used in Integrated Access Systems to allow transport of E1 based services such as point-to-point leased lines and ISDN Primary Rate Access. This module can only be used on the WAN-U card (801160).

7.3.3.1 Adtran E1/HDSL Module Installation

Install the Adtran E1/HDSL module on the WAN-U card by plugging its connector pins into the mating sockets of that card, in a fashion similar to that shown in Figure 7-9. You can install up to two Adtran E1/HDSL modules on the WAN-U card.

7.3.3.2 Adtran E1/HDSL Module Jumper/Switch Settings

The Adtran E1/HDSL module does not have any jumpers or switches.

7.3.4 PairGain T1/HDSL Module Description (82100)

You must install **two PairGain T1/HDSL (82100) modules on the WAN HDSL (802060) card**. Different symbols are used to identify modules installed on the WAN HDSL (802060) card. Table 7-1 lists the PairGain modules and corresponding symbols used.

Table 7-1. Symbols Used for Different Modules

Module	Symbol	Description
T1 Mini OEM Module	P-T1	PairGain Mini T1
No Module or No Response	NONE	Alarms will not be suppressed

7.3.4.1 PairGain T1/HDSL Module Installation

Install the PairGain T1/HDSL module on the WAN HDSL card by plugging its connector pins into the mating sockets of that card, in a fashion similar to that shown in Figure 7-8.

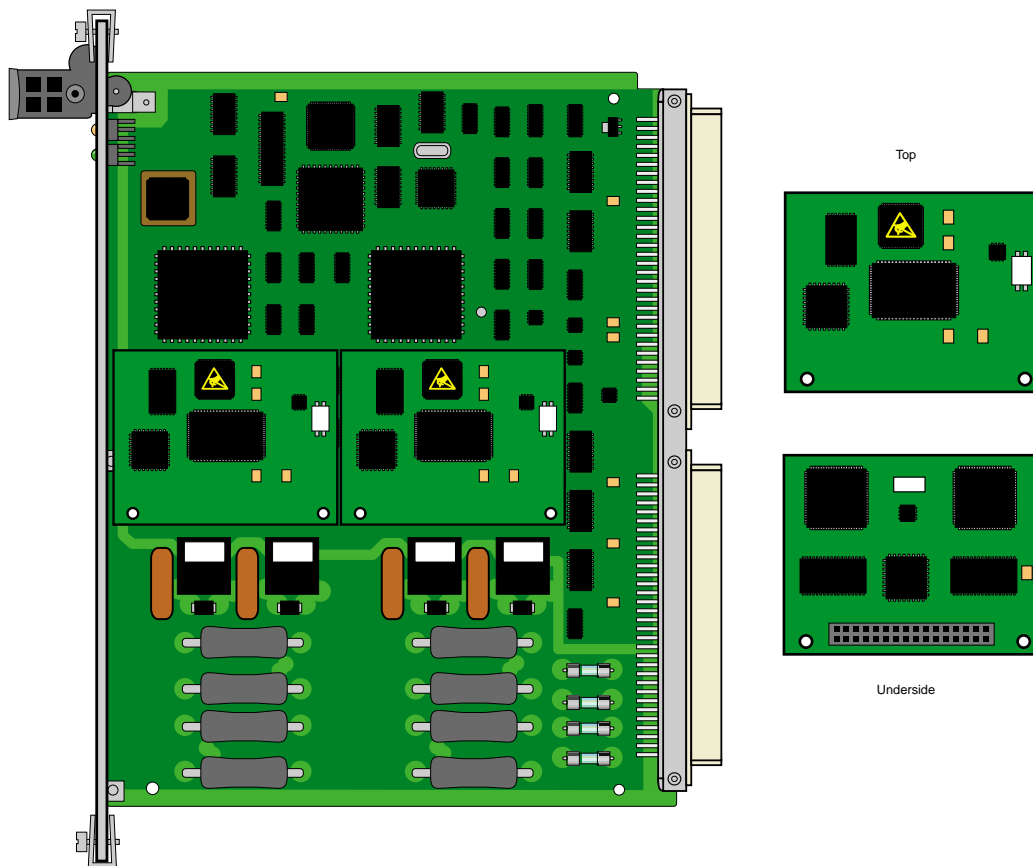

Figure 7-8. WAN HDSL Card with PairGain T1/HDSL Modules

7.3.4.2 PairGain T1/HDSL Module Jumper/Switch Settings

The HDSL PairGain module does not have any jumpers or switches.

7.3.5 Installing the WAN Cards

After installing the proper modules on the WAN cards, insert the WAN cards into the system chassis. Each system can have up to four WAN cards, which go into slots W1 through W4.

For a system with redundant WAN cards, always insert a WAN-R card into slot W4. If you install the WAN-R card into any other WAN card slot, it will work as a regular WAN card (not as a redundant card). Also make sure that the WAN-R card has the same types of modules installed on it as the associated primary WAN cards, and that those modules are installed in the same positions (ports 1 and 2), as shown in Figure 7-9.

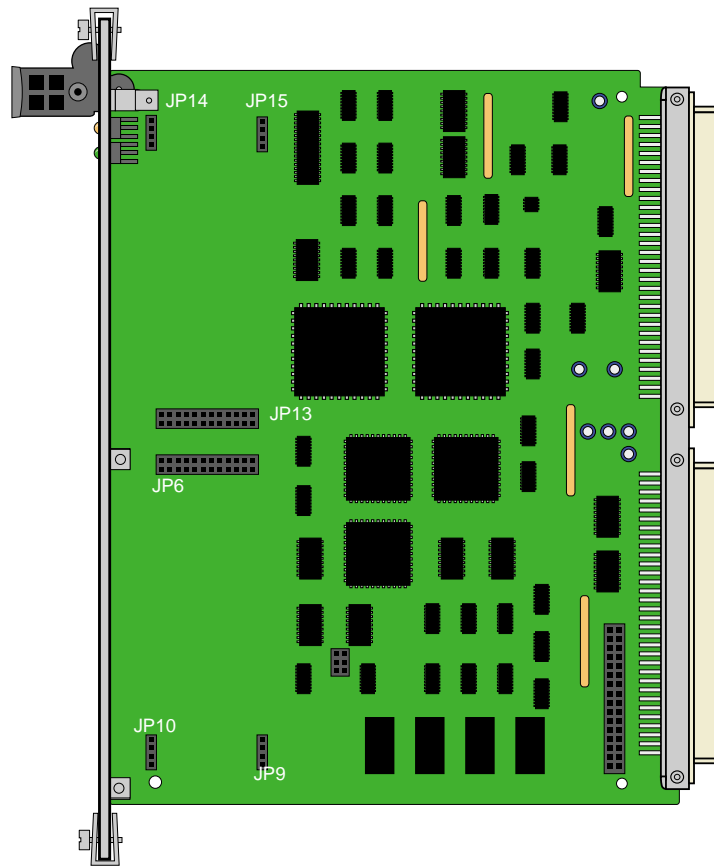

Figure 7-9. Installing DSX/CEPT Modules

7.4 WAN Card User Screens and Settings

7.4.1 T1 CSU and DSX Settings

The DSX/CEPT and CSU Modules for T1 operation have identical configuration parameters, which you must set on, the WAN Card Main Screen. To go to that screen, select the desired WAN card on the System Main Screen, then press <Enter>. Figure 7-10 shows a typical WAN Card Main Screen for T1 CSU or DSX operation.

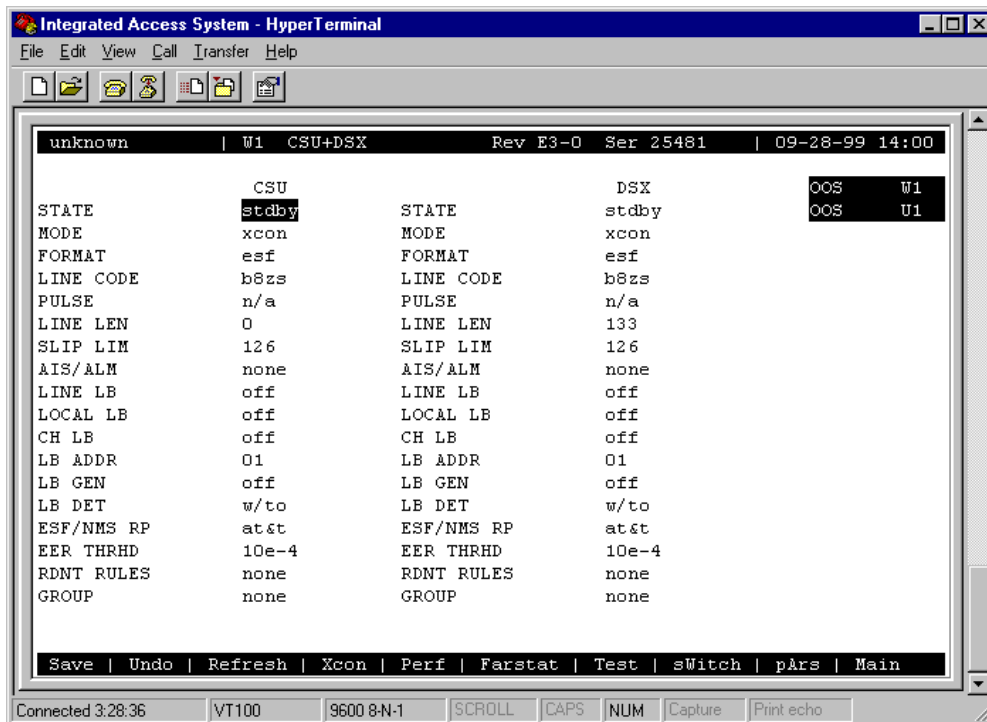

Figure 7-10. WAN Card Main Screen for T1 CSU and DSX

The headers of all WAN card screens show the types of modules installed on those cards. The above example shows a WAN DUAL card with a CSU module on port 1 and a DSX/CEPT module configured for T1 DSX operation on port 2. This card is installed in WAN card slot W1 of the system. Its screen header designation is therefore **W1 CSU+DSX**.

The DSX/CEPT and HDSL modules also have identical parameters. These are described in the next section of this chapter.

Table 7-2 lists several actions you can perform from the WAN Card Main Screen. These actions appear in the bottom-highlighted line of the screen. To perform an action, simply press the key corresponding to the capital letter of the desired action. For example, to save your parameter settings, press “s” to invoke the **Save** commands.

Table 7-2. T1 CSU and DSX Main Screen Actions

Action	Function
Save	Saves changes to settings
Undo	Returns all settings to the last saved state.
Refresh	Updates certain time-related information fields that are not automatically updated (e.g., performance and test data).
Xcon	Shows the cross-connect map for each WAN port.
Perf	Brings up the Performance Data Screen for the near-end system. See the Performance Data section of this chapter.
Farstat	Brings up the performance data for the far-end system. See the Far-End Data section of this chapter.
Test	Initiates and monitors testing of all WAN card ports. Refer to the Test section of this chapter.
sWitch	Allows you to switch WAN port operation to the redundant (WAN-R) card.
pArs	PARS (Premisys Automatic Rerouting System) feature protects the traffic of a failed T1/E1 transmission line in a ring network.
Main	Returns to the System Main Screen. If changes are made to settings and not saved, you will be prompted to save or lose changes.

Table 7-3 lists the CSU/DSX settings on the screen, along with their possible and default values. For information about cross-connects and for the DS0 time slot map used to connect your WAN to voice and data user cards.

In addition to the Local and Line Loopbacks described below, a single or dual WAN card with a CSU Module will recognize and respond to industry-standard T1 loop-up and loop-down codes generated and applied from the network or a remote device. However, the WAN card will ignore those codes if it has a DSX/CEPT Module.

Table 7-3. T1 CSU and DSX Option Settings and Defaults

Parameter	User Options	Notes	Default
STATE	stdby actv		stdby
MODE	xcon	1	xcon
FORMAT	d4 esf slc96 slcd4		esf
LINE CODE	ami b8zs	2	b8zs
PULSE	n/a trnsp z15s		n/a
LINE LEN	0 7.5 15.0	3	0
SLIP LIM	126 138		126
AIS/ALM	none tcodr	4	none
LINE LB	off on		off
LOCAL LB	off on		off
CH LB	off clr		off
LB ADDR	01-24		01
LB GEN	off llb plb nlb		off
LB DET	w/to off on		w/to

ESF/NMS RP	none at&t ansi c-fdl c-b7r e-fdl	5	at&t
EER THRHD	10e-4 thru 10e-9 none		10e-4
RDNT RULES	n/a none OOS CGA	6	none
GROUP	none 1 2 3 4	7	none

Notes:

1. The only valid option for Cross-Connect systems is **xcon**.
2. These options are valid only if you have a CSU and the Line Code is **ami**. If you have a CSU and the Line Code is **b8zs**, then this setting will default to **n/a**. If you have a DSX module, then this setting will always default to **n/a**.
3. These options are valid only if you have a CSU. If you have a DSX module, then the possible options are **0** (default), **133**, **266**, **399**, **533**, **655**, and **csu**.
4. The settings for AIS/ALM are affected by the setting of Group.
5. If the format is d4 or slc96, the only option to appear will be **none**.
6. If there is no redundant WAN card in the appropriate slot the only option that will appear is **n/a**.
7. Selection of GROUP is a two-step process. After identifying the group number (1-4), the user must select the secondary group (A, B, or C). At which point TCODR will then become available.

STATE

In the standby state, the WAN port is electrically disconnected from the network. Set this field to **stdby** (standby) while configuring WAN links, and then change it to **actv** (active) when starting normal operations. If the WAN is in loopback due to a command from a remote device, the loopback will be dropped if you switch to **stdby**.

MODE

In cross-connect systems, the Mode automatically defaults to (**xcon**).

FORMAT

The Format setting specifies the frame format to be used on the WAN link so that it matches the frame format used by the T1 carrier. Set the Format parameter based on the type of frame format the T1 carrier requires. If you are using an external Channel Service Unit (CSU), the frame format must match that of the CSU. The options are **d4** (normal superframe), **esf** (extended superframe), **slc96** (subscriber loop carrier) and **slcd4** (subscriber loop carrier - D4).

Table 7-4 lists the DS0 time slots and their corresponding SLC[®] assignments, based on Bellcore TR-TSY-000008.

LINE CODE

The Line Code setting matches the Line Code used by the T1 interface to that used by the T1 network. Set the Line Code to the type of Line Code used. If you are connected to an external CSU, the line code must match that of the CSU. The options are **ami** and **b8zs**.

PULSE

CSU modules with the Line Code configured for **ami** mode requires the WAN system or the attached customer equipment ensure pulse density (also known as ones density). In **z15s** mode, the system will monitor the outbound data stream and will place a “1” in the 16th bit position whenever it detects fifteen consecutive zeros. In the transparent mode (**trnsp**), the system will pass all incoming data (the DTE must provide 1s density). If the Line Code parameter for the CSU is **b8zs**, the Pulse option will default to **trnsp**. If the WAN link is equipped with a DSX plug-in module, this option will automatically default to **n/a**.

LINE LEN

The Line Length setting adjusts the T1 power level to compensate for the distance the signal must travel before it reaches the first T1 line repeater or other device. For a DSX interface, the options are **133**, **266**, **399**, **533**, and **655** feet. Or, choose **csu** to connect the DSX module to the equipment side of a collocated external CSU.

SLIP LIM

The Slip Limit defines how many bits of wander the WAN port will tolerate before forcing a frame slip. The options are **126** bits and **138** bits, which correspond to an older and a more recent version of the specification, respectively.

Table 7-4. DS0-to-SLC-96 Time Slot Conversion

Time Slot	SLC Channel Number			
	Shelf A	Shelf B	Shelf C*	Shelf D*
1	1	25	49	73
2	13	37	61	85
3	2	26	50	74
4	14	38	62	86
5	3	27	51	75
6	15	39	63	87
7	4	28	52	76
8	16	40	64	88

9	5	29	53	77
10	17	41	65	89
11	6	30	54	78
12	18	42	66	90
13	7	31	55	79
14	19	43	67	91
15	8	32	56	80
16	20	44	68	92
17	9	33	57	81
18	21	45	69	93
19	10	34	58	82
20	22	46	70	94
21	11	35	59	83
22	23	47	71	95
23	12	36	60	84
24	24	48	72	96
* Shelves C and D not supported in this release				

AIS/ALM

The AIS/ALM (Alarm Indication Signal/Alarm) setting allows you to specify the type of “keep-alive” signal the system will generate on one T1/E1 link if the other one fails. The AIS/ALM setting depends on the Frame Format selected for this WAN card. Table 7-5 shows the AIS/ALM settings for cross-connect systems.

Table 7-5. AIS/ALM Settings

System	Frame Format	AIS/ALM
Cross-Connect	D4	none, tcodr
	ESF	none, frm, unfrm
	SLC-96	note, orb13, orb16

In a cross-connect system, the options available for D4 or ESF frame format are **none** (no AIS signal is generated) and **tcodr** (transcoder operations). You can choose **tcodr** only after selecting the Group option described later in this section. The options for SLC-96 frame format are **note** (network office terminating equipment), **orb16** (Office Repeater Bay–16 frames), and **orb13** (Office Repeater Bay–13 frames). The AIS/ALM option for the SLCD4 format defaults to **n/a**.

LINE LB

The Line Loopback setting loops the T1/E1 line back toward the network, as shown in Figure 7-11. This loopback also continues sending the incoming data toward the CPE. Choosing **on** allows you to test the end-to-end T1/E1 circuit path from the far end. Choosing **off** disables the loopback and restores the normal signal path in both directions. If the WAN is in loopback due to a remote device, the loopback will be dropped if you choose **on**.

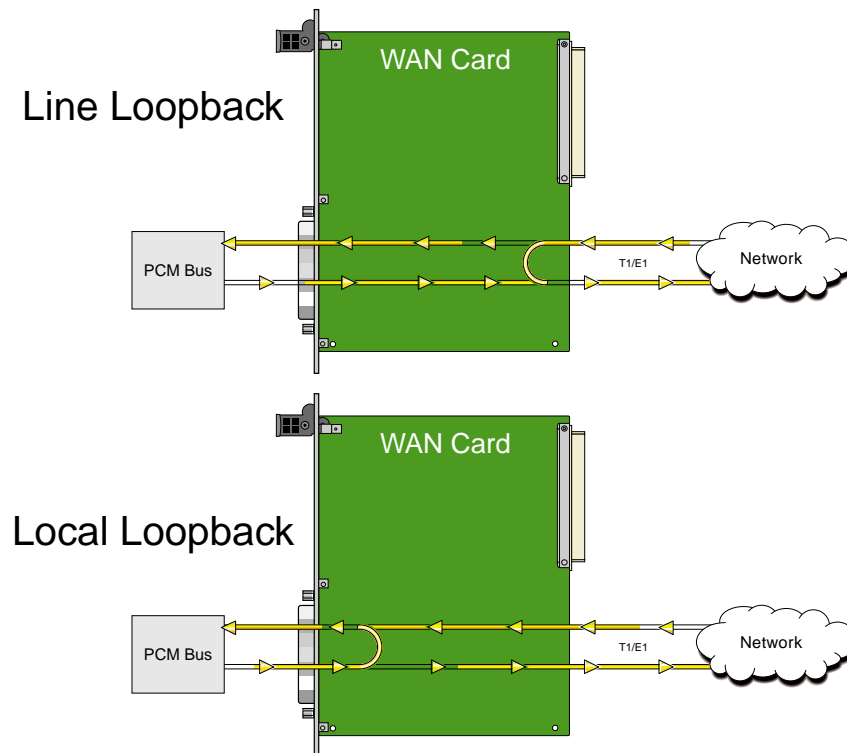

Figure 7-11. Line and Local Loopbacks

LOCAL LB

The Local Loopback setting allows you to loop the full T1/E1 line back toward the CPE, as shown in Figure 7-11. This loopback also continues sending CPE data toward the network. Choosing **on** allows you to test the local system. Choosing **off** disables the loopback and restores the normal signal path in both directions. If the WAN is in loopback due to a command from a remote device, the loopback will be dropped if you choose **on**.

CH LB

The Channel Loopback setting allows you to loop the data in an individual DS0 time slot on the WAN link toward the CPE (see Figure 7-12). However, you cannot use this feature to loop multiple time slots or any portions of them. Refer to the user card chapters for other loopback options that may allow you to loop part of a time slot or multiple time slots.

The loopback setting can be **off** or **clr** (clear). Clear means the entire 64 kbps clear-channel time slot will be looped back, but without the Robbed-Bit Signaling data that may normally be embedded in the time slot. If the WAN is in loopback due to a command from a remote device, the loopback will be dropped if you choose **clr**.

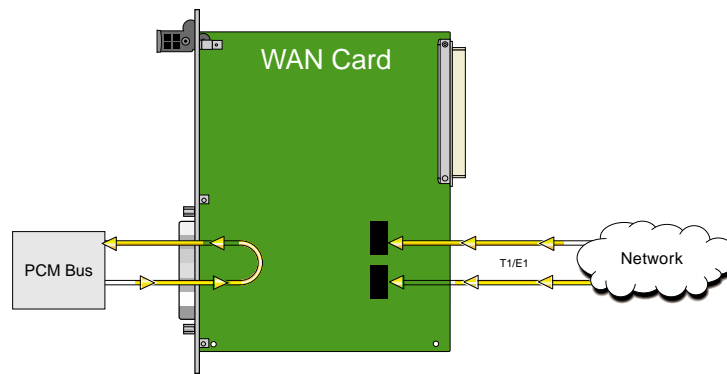

Figure 7-12. DS0 Time Slot Loopback

LB ADDR

The Loopback Address setting, when used in conjunction with the Channel Loopback setting, specifies which time slot will be looped back. Only one time slot may be looped back at a time for each WAN T1/E1 link. The options for T1 lines are **1** to **24**. For E1 lines, the options are **1** to **31**.

LB GEN

The Loopback Generate setting generates out-of-band diagnostic codes that are sent to the remote equipment. These codes are ANSI T1.403 compatible with T1 networks, and allow you to command a latching loopback at remote DS1 equipment. The options are **off**, **llb** (Line Loopback), **plb** (Payload Loopback), and **nlb** (Network Loopback). The **plb** setting is a loopback of the entire signal except the framing bits.

Selecting **off** generates a loopback deactivate command corresponding to the last activation command generated. e.g. if you send a **plb** command and then send an **off** command, the **off** command would be payload deactivate.

Note that the actual transmission of the command happens after you press 's' for **Save**. If you have already sent one of the loopback activation commands, it is recommend that you send an **off** command before sending another loopback activation command. e.g. this set of selections **plb, off, llb, off** transmits the following commands: payload activate, payload deactivate, line activate, and line deactivate.

LB DET

This option allows the card to detect DS1 channel, and ANSI T1.403 (8015 WAN only) loopbacks. When set to off, no T1 loopbacks can be detected. When set to on, T1 loopbacks will be detected and maintained until a loop down is detected. The with/time-out (w/to) is the same as on except that if no loop down is detected after 10 minutes, the loopback will self-terminate.

Currently WAN card with ESF Loopback is the only card that detects ANSI T1.403 loopback commands. The other WAN cards will only respond to "in-band" loopback codes. If the WAN is a loopback due to a command from a remote device, the loopback will be dropped if you switch to **off**.

ESF/NMS RP

This setting specifies the format in which performance statistics for the T1 link will be gathered and stored in the system. In ESF mode, these performance statistics are accessible to the carrier over the Facilities Data Link (FDL) as well as through the user interface. The options are **none**, **at&t**, **ansi**, **c-fdl**, **c-b7r** and **e-fdl**. The **at&t** option requires the statistics be gathered in accordance with AT&T Publication 54016 whereas the **ansi** option requires the ANSI T1.403 specification be used. Performance statistics are also available for D4 formatted T1 lines. See the "T1 Performance Monitoring" section later in this chapter for more detailed information on this topic.

The choice of **c-fdl** disables telco-side capability to access performance-monitoring information. The **c-fdl** option sends and receives network management information over the facility data link. The **c-b7r** option sends and receives the same information over time slot 24 on the T1 WAN link highlighted. The **e-fdl** option sends and receives T1 ESF-encapsulated network management information over the FDL.

EER THRHD

The Excessive Error Rate Threshold selects the error rate, which an alarm is declared. This setting interacts with the EER setting in the Alarm Filters of the system. The options are **10e-4** through **10e-9**, or **none**.

RDNT RULES

The selection of Redundancy Rules will define the method of determining what event will trigger a WAN port to switch to its redundant mate. The options are **none**, **OOS**, and **CGA**.

GROUP

The Group setting identifies a method of link-fail alarm propagation from upstream trunks to downstream tributaries when the system is configured for alarm transcoding.

The selection of a group is a two-step process. After identifying the group number (**1** to **4**), select the secondary group (**A** [child group], **B** [child group] or **C** [parent group]).

Figure 7-13 shows two system units with "parent-child" groupings. The child groups are designated as "A" and "B." The parent groups are designated "C".

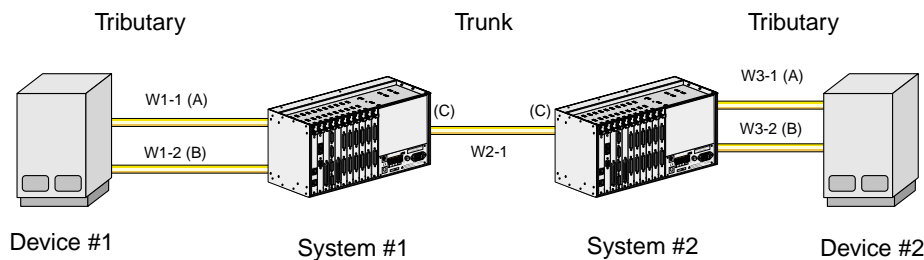

Figure 7-13. Using WAN Groups

The WAN links between the Device and the System Unit (A, B, A1, and B1) are called *tributaries*. The WAN link between the two SYS Units (C and C1) is referred to as a *trunk*.

In the normal condition (no WAN groups selected), a failure on any of the tributaries supplying Device 1 would be reported at SYS 1 and Device 1 only. A failure of the trunk from C to C1 would be reported at SYS 1 and 2 only.

When Groups are created at both system units, a trunk failure (C to C1) will inform all of the associated tributaries (A and B, A1 and B1) of that condition.

When groups are used in conjunction with the Network Management option (mentioned earlier) and the AIS/ALM is set to **tcodr**, a failure of any of the tributaries will propagate the failure through the trunk to the associated tributary at the other end (A to A1 or B to B1).

The following notification procedure is followed:

1. A Loss of Signal, Loss of Frame, Error Rate Exceeded, or AIS failure of the transmit leg of W1-1(A) occurs between Device 1 and SYS 1.

2. SYS 1 detects the failure on the receive leg and declares an alarm for W1-1(A).
3. SYS 1 sets the A Bit (Yellow Alarm) in the transmit leg of W1-1(A). Device 1 detects this condition and knows not to use W1-1(A).
4. SYS 1(C) sends an alarm message to SYS 2 (C1), telling it that W1-1(A) is either in a CGA_RED or AIS alarm.
5. SYS 2 sets the transmit leg of W3-1(A1) into AIS (CGA_RED). Device 2 detects this condition and knows not to use W3-1(A1).

When the original failure is corrected, the alarm is also cleared for downstream tributaries.

7.4.2 E1 CEPT/HDSL Settings

Figure 7-14 shows the WAN Card Main Screen for E1 operation. This example shows a WAN-U card with two Adtran E1/HDSL modules in system chassis slot W1.

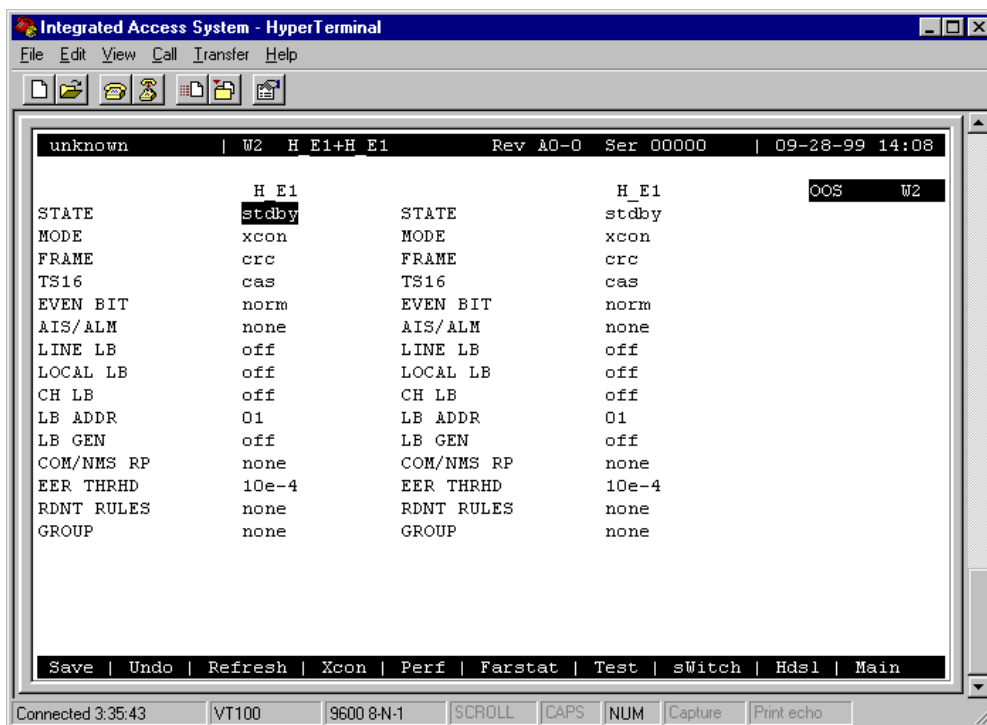

Figure 7-14. WAN Card Main Screen for CEPT/HDSL

The WAN-U card only accepts Adtran E1/HDSL modules. The other WAN cards only accept CSU or DSX/CEPT modules, which are described in the previous section.

The only difference between Main Screens for CEPT/HDSL operation is the addition of the **Hdsl** action on the bottom line of the screen and the top of the screen identifying slot W1 (H_E1+H_E1).

Table 7-6 summarizes the actions you can perform from this screen, and Table 7-7 lists the CEPT/HDSL settings controlled on the screen along with their possible and default values.

Table 7-6. E1 HDSL Screen Actions

Action	Function
Save	Saves changes to settings.
Undo	Returns all settings to the last saved state.
Refresh	Updates certain time-related information fields that are not automatically updated (i.e., performance and test data).
Xcon	Shows the time slot cross-connect map for each WAN port.
Perf	Brings up the Performance Data Screen. See the Performance Data section of this chapter.
Farstat	Shows the far-end network register data.
Test	Initiates and monitors testing of all WAN card ports. Refer to the Test section of this chapter.
sWitch	Allows you to switch WAN port operations to the redundant (WAN-R) card.
Hdsl	Brings up the HDSL Screen described later in this chapter. This command is shown only for a WAN-U card.
Main	Returns to the System Main Screen. If changes are made to settings and not saved, you will be prompted to save or abandon your changes.

Table 7-7. E1 HDSL Screen Option Settings and Defaults

Parameter	User Options	Notes	Default
STATE	stdby actv		stdby
MODE	xcon		xcon
FRAME	crc d-frm		crc
TS16	cas ccs nos		cas
EVEN BIT	norm inv		norm
AIS/ALM	none tcodr	1	none
LINE LB	off on		off
LOCAL LB	off on		off
CH LB	off clr		off
LB ADDR	01-31 (user-selectable)	2	01
LB GEN	off llb plb nlb		off
COM/NMS RP	none c-sa4 c-br7 e-sa4 (c-fdl)	3	none
EER THRHD	10e-4 through 10e-9 none		10e-4
RDNT RULES	n/a none OOS CGA	4	none
GROUP	none 1 2 3 4	5	none

Notes:

1. AIS/ALM will show **none** until the GROUP is selected.
2. The up and down arrow keys are used to scroll through the loopback address values.
3. The Farstat registers will not work properly for E1 operations unless the **c-sa4** option is selected for the COM/NMS RP parameter.
4. If there is no redundant WAN card in the appropriate slot, the only option that will appear is **n/a**.
5. Selection of GROUP is a two-step process. After identifying the group number (1-4), the user must select the secondary group (A, B or C).

STATE

In the standby state, the WAN port is electrically disconnected from the external network. Set State setting to **stdby** (standby) when setting up your WAN links, then changes it to **actv** (active) when starting normal operations.

MODE

In cross-connect systems, Mode automatically defaults to **xcon**.

FRAME

The Frame setting toggles the frame type from **crc** (Cyclic Redundancy Check, 4th level) to **d-frm** (Double Frame).

TS 16

The TS 16 setting changes the signaling usage of slot 16 for **cas** (Channel Associated Signaling), **ccs** (Common Channel Signaling) or **nos** (No Signaling). In the first two options, time slot 16 is used to carry signaling information for all channels on the E1. If **nos** is selected, then time slot 16 becomes available for user data.

EVEN BIT

Setting the Even Bit parameter for **inv** will cause the system to invert every even bit in every DS0 time slot. This setting should only be used if the entire E1 stream is composed of PCM voice, to ensure minimum-ones density.

AIS/ALM

The AIS/ALM (Alarm Indication Signal/Alarm) setting, allows the user to specify the type of “keep-alive” signal that the system will generate on one E1 should the other fail. After GROUP is selected, the two options for this setting are **none** and **tcodr** (for transcoder operations).

LINE LB

The Line Loopback setting controls looping of the full E1 line back to the network. When **on**, this setting allows end-to-end testing of the line.

LOCAL LB

The Loopback setting controls looping of the full E1 line back to the PCM bus. The options are **off** and **on**. When **on**, this setting allows testing of local equipment. The system generates a "Keep Alive–Type 1" pattern on the E1 line.

CH LB

The Channel Loopback setting allows you to place individual DS0 channels in loopback toward the PCM bus. A channel loopback loops a single DS0 channel and cannot be used to loop multiple DS0s or a portion of a DS0. Refer to user cards for other loopback options, which may allow you to loop part of a channel or multiple channels. The options are **on** and **off**.

LB ADDR

The Loopback Address setting, in conjunction with the Channel Loopback setting, specifies which channel is to be looped back. Only one channel may be looped back at any one time for each E1 link. The valid selections for E1 lines are **1-31**. Do not loop time slot 16 unless the E1 interface is in no signaling (**nos**) mode.

LB GEN

The Loopback Generate setting generates out-band diagnostic codes that are sent to the remote equipment. These codes are compatible with DDS networks and allow you to command a latching loopback at remote DDS equipment. The options are **off**, **llb** (Line Loopback), **plb** (Payload Loopback) and **nlb** (Network Loopback).

Selecting **off** generates a loopback deactivate command corresponding to the last activation command generated. e.g. if you send a **plb** command and then send an **off** command, the **off** command would be payload deactivate. Note that the actual transmission of the command happens after you press ‘s’ for **Save**. If you have already sent one of the loopback activation

commands, it is recommended that you send an **off** command before sending another loopback activation command. e.g. this set of selections **plb, off, llb, off** transmits the following commands: payload activate, payload deactivate, line activate, and line deactivate.

COM/NMS RP

The Communications/Network Management System Report setting tells the system where to send TCP/IP packets from the NMS configuration selected on the Interface card. The options are **none** (no NMS), **c-sa4** (use SA4 channel for NMS information), **c-b7r** (send NMS information to a B7R card on time slot 31), and **e-sa4** (send NMS information in a proprietary ESF format via the SA4 channel to a NTU).

EER THRHD

The Excessive Error Rate Threshold selects the error rate, which an alarm is declared. This setting interacts with the EER setting in the Alarm Filters of your system. The options are **10e-4** through **10e-9**, or **none**.

RDNT RULES

The selection of Redundancy Rules will define the method of determining what event will trigger a WAN port to switch to its redundant mate. The options are **none**, **OOS**, or **CGA**. See Chapter 3-C for more information on redundant WAN card operations. If there is no redundant WAN card in the appropriate slot, the only option that will appear is **n/a**.

GROUP

The Group setting identifies a method of link-fail alarm propagation from upstream trunks to downstream tributaries. Selection of group is a two-step process. After identifying the group number (1-4), the user must select the secondary group (A [child group], B [child group], or C [parent group]). The group setting is normally used for transcoder applications. See the groups diagram and discussion earlier in this chapter.

7.4.3 WAN HDSL Card Main Screen

Figure 7-15 shows the WAN HDSL Card Main Screen for PairGain T1/HDSL operation. This example shows a WAN HDSL card with two PairGain T1/HDSL (821) modules. The P-T1/P-T1 Modules for T1 operation have identical configuration parameters, which you must set on the WAN Card Main Screen. To go to that screen select the desired WAN card on the System Main Screen, then press <Enter>.

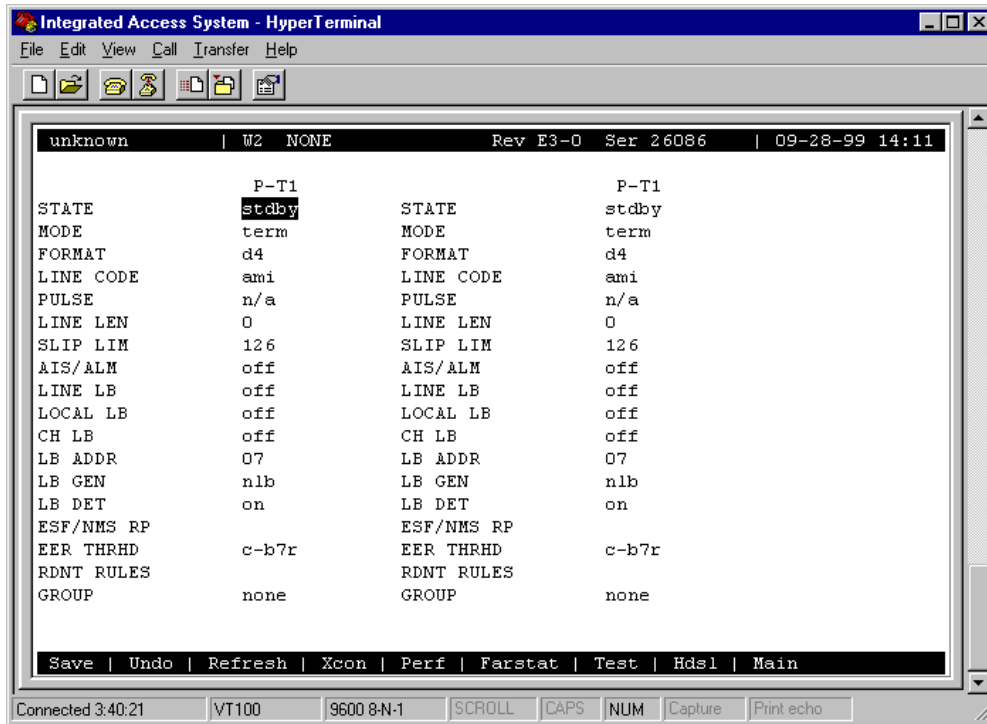

Figure 7-15. WAN HDSL Card Main Screen for PairGain T1/HDSL Modules

Table 7-8 lists several actions you can perform from the WAN HDSL Card Main Screen. These actions appear in the bottom-highlighted line of the screen. To perform an action, simply press the key corresponding to the uppercase letter of the desired action. For example, to save your parameter settings, press “s” to invoke the **Save** commands. The only difference between Main Screens for PairGain T1/HDSL operation is the addition of the HDSL action at the bottom of the screen. The WAN HDSL Card only accepts PairGain T1/HDSL modules.

Table 7-8. WAN HDSL Card Main Screen Actions

Action	Function
Save	Saves changes to settings
Undo	Returns all settings to the last saved state.
Refresh	Updates certain time-related information fields that are not automatically updated (e.g., performance and test data).
Xcon	Shows the cross-connect map for each WAN port.
Perf	Brings up the Performance Data Screen for the near-end system. See the Performance Data section of this chapter.
Farstat	Brings up the performance data for the far-end system. See the Far-End Data section of this chapter.
Test	Initiates and monitors testing of all WAN card ports. Refer to the Test section of this chapter.
Hdsl	Brings up the PairGain T1/HDSL WAN Screen.

Main	Returns to the System Main Screen. If changes are made to settings and not saved, you will be prompted to save or lose changes.
------	---

Table 7-9 lists the WAN HDSL Card settings on the screen for PairGain T1/HDSL, along with their default values.

Table 7-9. WAN HDSL Card Option Settings and Defaults

Parameter	User Options	Notes	Default
STATE	stdby actv		stdby
MODE	xcon		xcon
FORMAT	d4 esf	1	esf
LINE CODE	auto	2	auto
PULSE	n/a		n/a
LINE LEN	0		0
SLIP LIM	126 138		126
AIS/ALM	none		none
LINE LB	n/a		n/a
LOCAL LB	off on		off
CH LB	off clr		off
LB ADDR	01-24		01
LB GEN	off llb plb nlb		off
LB DET	w/to off on		w/to
ESF/NMS RP	none at&t ansi c-fdl c-b7r e-fdl		at&t
EER THRHD	10e-4 thru 10e-9 none		10e-4
RDNT RULES	none		none
GROUP	none 1 2 3 4		none

Notes:

1. The “FORMAT” field is for setting the ACFA framer. The options for Format are “d4” and “esf”. The same Format should be used at both ends of a circuit.
2. The “LINE CODE” field is set to “auto” and is determined by the HDSL module and set automatically.

STATE

In the standby state, the WAN port is electrically disconnected from the network. Set this field to **stdby** (standby) while configuring WAN links, and then change it to **actv** (active) when starting normal operations. If the WAN is in loopback due to a command from a remote device, the loopback will be dropped if you switch to **stdby**.

MODE

In cross-connect systems, the Mode automatically defaults to (**xcon**).

FORMAT

The Format setting specifies the frame format to be used on the WAN link so that it matches the frame format used by the T1 carrier. Set the Format parameter based on the type of frame format the T1 carrier requires. The options are **d4** (normal superframe) and **esf** (extended superframe). The same format should be used at both ends of a circuit.

LINE CODE

The Line Code setting matches the Line Code used by the T1 interface. This option is set to **auto** and is determined by the HDSL module.

PULSE

This option is not available at the present time. **n/a**.

LINE LEN

The Line Length setting adjusts the T1 power level to compensate for the distance the signal must travel before it reaches the first T1 line repeater or other device. The Line Length for the PairGain T1/HDSL defaults to **0**.

SLIP LIM

The Slip Limit defines how many bits of wander the WAN port will tolerate before forcing a frame slip. The options are **126** bits and **138** bits, which correspond to an older and a more recent version of the specification, respectively.

Table 7-10. DS0-to-SLC-96 Time Slot Conversion

Time Slot	SLC Channel Number			
	Shelf A	Shelf B	Shelf C*	Shelf D*
1	1	25	49	73
2	13	37	61	85
3	2	26	50	74
4	14	38	62	86
5	3	27	51	75
6	15	39	63	87
7	4	28	52	76
8	16	40	64	88
9	5	29	53	77
10	17	41	65	89
11	6	30	54	78
12	18	42	66	90

13	7	31	55	79
14	19	43	67	91
15	8	32	56	80
16	20	44	68	92
17	9	33	57	81
18	21	45	69	93
19	10	34	58	82
20	22	46	70	94
21	11	35	59	83
22	23	47	71	95
23	12	36	60	84
24	24	48	72	96
* Shelves C and D not supported in this release				

AIS/ALM

The AIS/ALM (Alarm Indication Signal/Alarm) setting allows you to specify the type of “keep-alive” signal the system will generate on one T1/E1 link if the other one fails. The AIS/ALM setting depends on the Frame Format selected for this WAN card. Table 7-5 shows the AIS/ALM settings for cross-connect systems.

Table 7-11. AIS/ALM Settings

System	Frame Format	AIS/ALM
Cross-Connect	D4	none, tcodr
	ESF	none, frm, unfrm

In a cross-connect system, the options available for D4 or ESF frame format are **none** (no AIS signal is generated) and **tcodr** (transcoder operations). You can choose **tcodr** only after selecting the Group option described later in this section.

LINE LB

The default setting for Line Loopback for the WAN HDSL card is **n/a**.

LOCAL LB

The Local Loopback setting allows you to loop the full T1/E1 line back toward the CPE. Choosing **on** allows you to test the local system. Choosing **off** disables the loopback and restores the normal signal path in both directions. If the WAN is in loopback due to a command from a remote device, the loopback will be dropped if you choose **on**.

CH LB

The Channel Loopback setting allows you to loop the data in an individual DS0 time slot on the WAN link toward the CPE (see Figure 7-12). However, you cannot use this feature to loop multiple time slots or any portions of them. Refer to the user card chapters for other loopback options that may allow you to loop part of a time slot or multiple time slots.

The loopback setting can be **off** or **clr** (clear). Clear means the entire 64 kbps clear-channel time slot will be looped back, but without the Robbed-Bit Signaling data that may normally be embedded in the time slot. If the WAN is in loopback due to a command from a remote device, the loopback will be dropped if you choose **clr**.

LB ADDR

The Loopback Address setting, when used in conjunction with the Channel Loopback setting, specifies which time slot will be looped back. Only one time slot may be looped back at a time for each WAN T1/E1 link. The options for T1 lines are **1** to **24**. For E1 lines, the options are **1** to **31**.

LB GEN

The Loopback Generate setting generates out-of-band diagnostic codes that are sent to the remote equipment. These codes are ANSI T1.403 compatible with T1 networks, and allow you to command a latching loopback at remote DS1 equipment. The options are **off**, **llb** (Line Loopback), **plb** (Payload Loopback), and **nlb** (Network Loopback). The **plb** setting is a loopback of the entire signal except the framing bits.

Selecting **off** generates a loopback deactivate command corresponding to the last activation command generated. e.g. if you send a **plb** command and then send an **off** command, the **off** command would be payload deactivate. Note that the actual transmission of the command happens after you press “s” for **Save**.

If you have already sent one of the loopback activation commands, it is recommended that you send an **off** command before sending another loopback activation command. e.g. this set of selections **plb**, **off**, **llb**, **off** transmits the following commands: payload activate, payload deactivate, line activate, and line deactivate.

LB DET

This option allows the card to detect DS1 channel, and ANSI T1.403 (801560 and 802060 WANs only) loopbacks. When set to **off**, no T1 loopbacks can be detected. When set to **on**, T1 loopbacks will be detected and maintained until a loop down is detected. The with/time-out (**w/to**) is the same as **on** except that if no loop down is detected after 10 minutes, the loopback will self-terminate.

The WAN HDSL (802060) card and WAN ESF LPBK (801560) with ESF Payload Loopback are the only cards that detect ANSI T1.403 loopback commands. The other WAN cards will only respond to “in-band” loopback codes. If the WAN is in loopback due to a command from a remote device, the loopback will be dropped if you switch to **off**.

ESF Loopback Detection is supported for payload loopback activation and deactivation, as well as for universal loopback deactivation. ESF line loopback activation is not supported. To cause a remote unit to go to line loopback use NREM or CREM from WAN HDSL screen (Figure 7-24). Detection of remote inband loopbacks generated using the test screen is not supported, to cause a remote unit to go to line loopback use NREM or CREM from WAN HDSL screen (Figure 7-24).

Note that “LB DET” is for ESF and in-band loopbacks. It is not possible to disable the detection of remote PairGain loopbacks, although you may still have timeout using the “LB TIMEOUT” field in WAN HDSL screen (Figure 7-24). Line Loopback is not supported from the WAN Main screen, to activate a line loopback use NREM or CREM from WAN HDSL screen (Figure 7-24). Local loopback of the WAN Main screen does not timeout and is independent of the loopbacks from the WAN HDSL screen.

ESF/NMS RP

This setting specifies the format in which performance statistics for the T1 link will be gathered and stored in the system. In ESF mode, these performance statistics are accessible to the carrier over the Facilities Data Link (FDL) as well as through the user interface. The options are **none**, **at&t**, **ansi**, **c-fdl**, **c-b7r** and **e-fdl**. The **at&t** option requires the statistics be gathered in accordance with AT&T Publication 54016 whereas the **ansi** option requires the ANSI T1.403 specification be used. Performance statistics are also available for D4 formatted T1 lines. See the “T1 Performance Monitoring” section later in this chapter for more detailed information on this topic.

The choice of **c-fdl** disables telco-side capability to access performance-monitoring information. The **c-fdl** option sends and receives network management information over the facility data link. The **c-b7r** option sends and receives the same information over time slot 24 on the T1 WAN link highlighted. The **e-fdl** option sends and receives T1 ESF-encapsulated network management information over the FDL.

EER THRHD

The Excessive Error Rate Threshold selects the error rate, which an alarm is declared. This setting interacts with the EER setting in the Alarm Filters of the system. The options are **10e-4** through **10e-9**, or **none**.

RDNT RULES

The selection of Redundancy Rules will define the method of determining what event will trigger a WAN port to switch to its redundant mate. The options are **none**, **OOS**, and **CGA**.

GROUP

The Group setting identifies a method of link-fail alarm propagation from upstream trunks to downstream tributaries when the system is configured for alarm transcoding.

The selection of a group is a two-step process. After identifying the group number (**1** to **4**), select the secondary group (**A** [child group], **B** [child group] or **C** [parent group]).

Figure 7-13 shows two system units with "parent-child" groupings. The child groups are designated as "A" and "B." The parent groups are designated "C".

The WAN links between the Device and the System Unit (A, B, A1, and B1) are called *tributaries*. The WAN link between the two SYS Units (C and C1) is referred to as a *trunk*.

In the normal condition (no WAN groups selected), a failure on any of the tributaries supplying Device 1 would be reported at SYS 1 and Device 1 only. A failure of the trunk from C to C1 would be reported at SYS 1 and 2 only.

When Groups are created at both system units, a trunk failure (C to C1) will inform all of the associated tributaries (A and B, A1 and B1) of that condition.

When groups are used in conjunction with the Network Management option (mentioned earlier) and the AIS/ALM is set to **tcodr**, a failure of any of the tributaries will propagate the failure through the trunk to the associated tributary at the other end (A to A1 or B to B1).

The following notification procedure is followed:

1. A Loss of Signal, Loss of Frame, Error Rate Exceeded, or AIS failure of the transmit leg of W1-1(A) occurs between Device 1 and SYS 1.
2. SYS 1 detects the failure on the receive leg and declares an alarm for W1-1(A).
3. SYS 1 sets the A Bit (Yellow Alarm) in the transmit leg of W1-1(A). Device 1 detects this condition and knows not to use W1-1(A).
4. SYS 1(C) sends an alarm message to SYS 2 (C1), telling it that W1-1(A) is either in a CGA_RED or AIS alarm.
5. SYS 2 sets the transmit leg of W3-1(A1) into AIS (CGA_RED). Device 2 detects this condition and knows not to use W3-1(A1).

When the original failure is corrected, the alarm is also cleared for downstream tributaries.

7.4.4 Cross-Connect (XCON)

The Cross-Connect (**Xcon**) command in the Main WAN screen allows you to view the time slot or DS0 assignments that have been set up in the system. Highlight the WANs on the card and press the “**x**” (**Xcon**) to select Cross-Connect. Either an E1 screen (Figure 7-16) or a T1 screen (Figure 7-17) will appear, depending upon the WAN highlighted. This is a display-only screen. Time slot and cross-connect configuration are discussed in the System Operations chapter of this manual.

The screenshot shows a HyperTerminal window titled "Integrated Access System - HyperTerminal". The window displays a table of cross-connect configurations. The table has columns for TS, XCON, TS, CIRCUIT_ID, TS, XCON, TS, and CIRCUIT_ID. The data is as follows:

TS	XCON	TS	CIRCUIT_ID	TS	XCON	TS	CIRCUIT_ID
0	frame align		64k	16	cas		64k
1	u1-1	A-01	user_circuit	17	u2-2	D-07	user_circuit
2	u1-2	A-02	user_circuit	18	u2-2	D-08	user_circuit
3	u1-3	A-03	user_circuit	19	u2-2	D-09	user_circuit
4	u1-4	A-04	user_circuit	20	u2-2	D-10	user_circuit
5	u1-5	A-05	user_circuit	21	u2-2	D-11	user_circuit
6	u1-6	A-06	user_circuit	22	u3-1	A-09	user_circuit
7	u1-7	A-07	user_circuit	23	u3-2	A-10	user_circuit
8	u1-8	A-08	user_circuit	24	u3-3	A-11	user_circuit
9	u2-1	D-00	user_circuit	25	u3-4	A-12	user_circuit
10	u2-1	D-01	user_circuit	26	u3-5	A-13	user_circuit
11	u2-1	D-02	user_circuit	27	u3-6	A-14	user_circuit
12	u2-1	D-03	user_circuit	28	u3-7	A-15	user_circuit
13	u2-1	D-04	user_circuit	29	u3-8	A-17	user_circuit
14	u2-1	D-05	user_circuit	30			
15	u2-2	D-06	user_circuit	31			

At the bottom of the window, there are buttons for "Refresh", "Test", and "Main".

Figure 7-16. E1 Cross-Connect Screen (display only)

TS	XCON	TS	CIRCUIT_ID	TS	XCON	TS	CIRCUIT_ID
1	w2-1	D-03	user_circuit	13	w3-2	A-10	user_circuit
2	w2-1	D-04	user_circuit	14	w3-3	A-11	user_circuit
3	w2-1	D-05	user_circuit	15	w3-4	A-12	user_circuit
4	w2-1	D-00	user_circuit	16	w3-5	A-13	user_circuit
5	w2-1	D-01	user_circuit	17	w3-6	A-14	user_circuit
6	w2-1	D-02	user_circuit	18	w3-7	A-15	user_circuit
7				19	w3-8	A-17	user_circuit
8				20			
9				21			
10				22			
11				23			
12	w3-1	A-09	user_circuit	24			

unknown | V1/05 CSU+CSU Rev E3-0 Ser 26096 | 10-04-99 16:56

Refresh | Test | Main

Figure 7-17. T1 WAN Cross-Connect Screen (display only)

7.4.5 Performance Data

All WAN cards gather performance data. The performance data for a T1 or E1 line is viewed by typing “**p**” in the WAN Card Main Screen, to invoke the **Perf** command. Performance data is accumulated for 15-minute increments that include the current period and the previous 96 periods (24 hours), which are accessed via the **pgUp** and **pgDn** commands of the Main Screen.

In the T1 environment, an error is defined as any CRC-6, Controlled Slip, or Out of Frame (OOF) error for **ESF** framing, and any Bipolar Violation (BPV), Controlled Slip, or OOF error for the D4 format. In an E1 environment, an error is defined as any CRC-4 error, Controlled Slip, or OOF error.

Figure 7-18 shows a typical T1 Performance Data Screen. The E1 screen is similar except for the actions on its bottom line, where **uSerregs** and **Networkregs** commands are not provided. The performance statistics are gathered and displayed in 15-minute intervals. Lines in each of the columns represent periods when no seconds have accumulated.

In the AT&T mode, two sets of registers accumulate performance data for T1 WAN links. The user registers and network registers are driven by the same errored events. However, they can be cleared separately. You can view both the user and network registers, but you can only clear the user registers. The network only has access to the network registers, and can only clear those registers. The ANSI and E1 WAN links have only one set of registers.

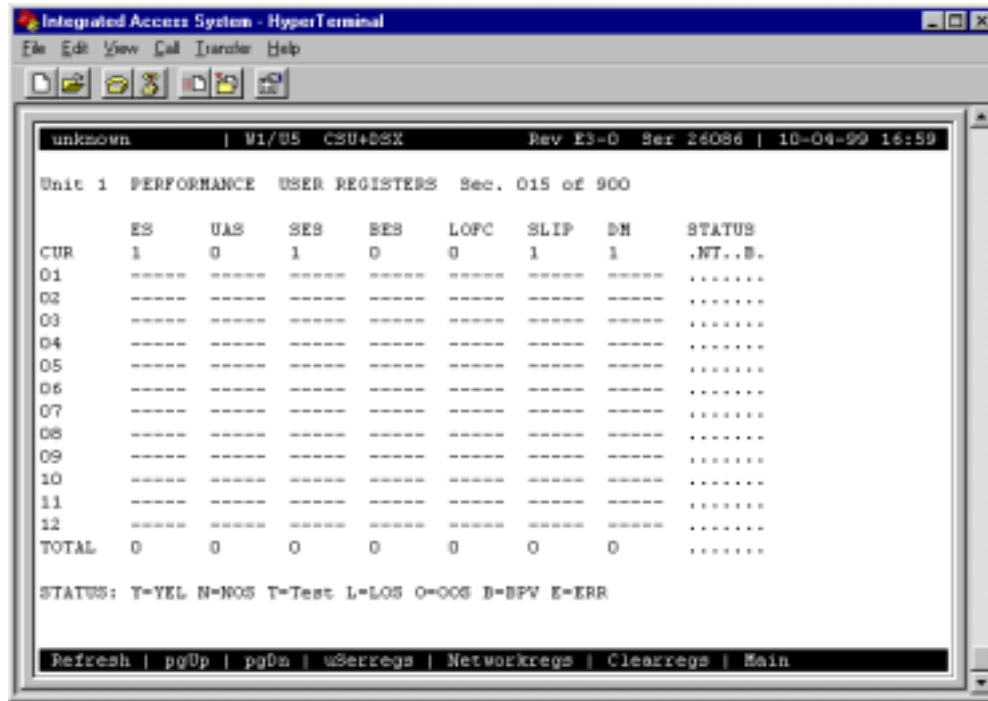

Figure 7-18. Typical Performance Data Screen

Table 7-12 lists the actions available from the Performance Data Screen.

Table 7-12. Performance Data Screen Actions

Action	Function
Refresh	Because statistics are not calculated in real time, the Refresh command must be used to update the screen with new information.
pgUp	Pages through the performance statistics for the current 15 minute period and periods 96-1.
pgDn	Pages through the performance statistics for the current 15 minute period and periods 1-96.
uSerregs	Allows you to view the User Registers. Not shown for E1 operations because it is the only set of registers for that mode.
Networkregs	Allows you to view the Network Registers. When you are viewing the network registers, the Clear Registers option disappears. (This action is not available in D4 mode or E1 operations.)
Clearregs	Clears the User Registers. Network statistics remain the same.
Main	Returns to the WAN Card Main Screen.

ES

An Errored Second (ES) is a second with one or more CRC-6 (ESF), BPV (D4/D-Frame), or CRC-4 (E1) errors, one or more Out-Of-Frame (OOF) errors, or one or more Controlled Slips.

UAS

An Unavailable Second (UAS) is any second during which service is unavailable. An unavailable signal state is declared after ten consecutive Severely Errored Seconds (SESs) are logged. An unavailable state is cleared after ten consecutive non-Severely Errored Seconds are logged. Unavailable Seconds are also accumulated if the card has an out-of-service (OOS) condition.

SES

A Severely Errored Second (SES) is any second with 320 or more CRC-6 (T1 ESF), BPV (T1 D4/D-frame), or CRC-4 (E1) errors. Or, an SES can be any second with one or more Out-Of-Frame (OOF) errors.

BES

A Bursty Errored Second (BES) is any second with more than one and fewer than 320 CRC-6 (ESF), BPV (D4/D-frame), or CRC-4 (E1) errors.

LOFC

The Loss of Frame Count (LOFC) is the number of times a Loss Of Frame (LOF) is declared. An LOF is declared after 2.5 seconds of a continuous Loss Of Synchronization (LOS) or Out-Of-Frame (OOF) condition. The LOF is cleared after no more than 15 consecutive seconds without another LOS or OOF.

SLIP

A Slipped Second is any second that contains one or more Controlled Slips. A Controlled Slip is the deletion or replication of a T1 or E1 frame by the receiving equipment.

DM

A Degraded Minute (DM) is any minute during the reporting period that has an error rate greater than 10^{-6} as described in ITU-T G.821. The count for this field is from 1 to 15, rather than 1 to 900 for the other fields.

STATUS

If one of the described errors occurs during any of the 15-minute intervals, the status column for that period would display the code for that error. The codes are displayed at the bottom of the screen. The values are **Y** (Yellow Alarm received), **N** (No Signal), **T** (Test Mode - line loopback, local loopback, payload loopback, or standby), **L** (Loss of Synchronization – 2 out of 4 frame bits in error), **O** (Out of Service), **B** (Bipolar Violation), and **E** (Excessive Error Rate).

7.4.6 Far-End Performance Data

The Far-End Performance Data Screen is similar to the Performance Data Screen. The same statistics are collected in a slightly different manner. Figure 7-19 shows a typical display of far-end network register data in the AT&T mode. To view the far-end performance data, press “**f**” (**Farstat** command) in the WAN Card Main Screen.

When **Farstat** is selected in the T1 AT&T mode, an FDL message is sent to the far end, requesting the network register data from there. This data is displayed on the local terminal. There will be a slight time delay in the data display.

When **Farstat** is selected in the ANSI T1.403 mode, the far end generates one-second performance reports and sends them to the local system, where they are then stored.

To view E1 far-end statistics, you must select **c-sa4** as the COM/NMS RP setting.

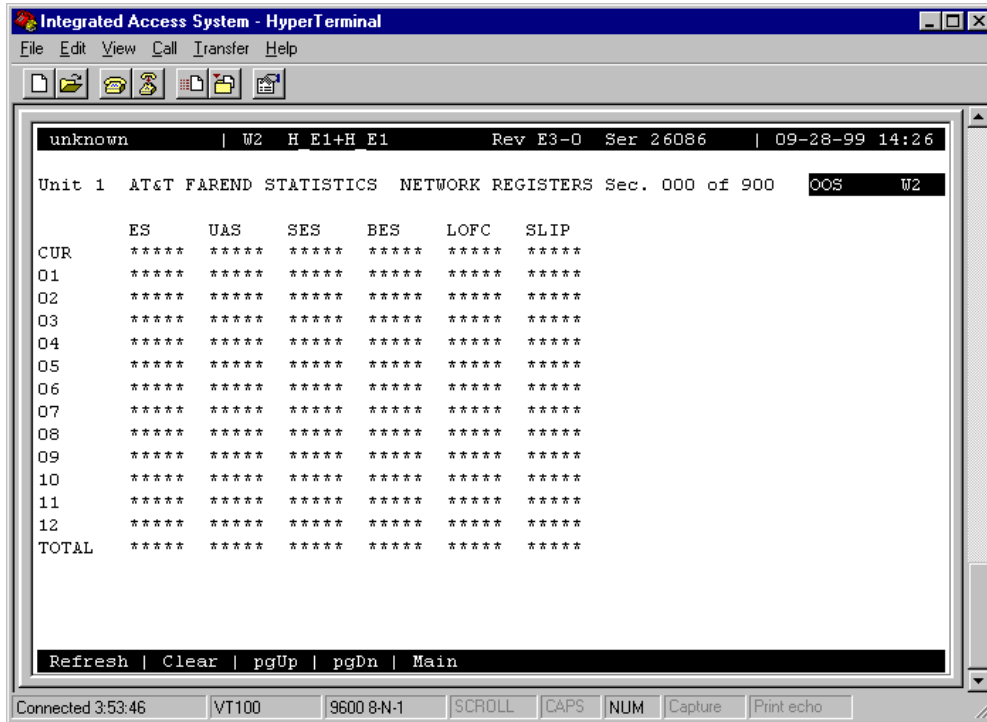

Figure 7-19. Typical Far-End Performance Data Screen

Press “c” (Clear command) from the bottom line of this screen to send a FDL message to the far end and also clear the local display. The following message will now appear:

“Ok to clear performance (y/n)?”

Press “y” to clear the statistics, or “n” to leave the screen contents intact. To view the far-end information again, press “r” (restore) to send an FDL message and refresh the screen. Table 7-13 lists the actions available from the above screen.

Table 7-13. Far-End Performance Data Screen Actions

Action	Function
Refresh	Because data is not calculated in real time, the Refresh command must be used to update the screen with new information.
Clear	Clears the Far-End Network Registers display on the local terminal.
PgUp	Pages through the performance statistics for the current 15-minute period and periods 96-1.
PgDn	Pages through the performance statistics for the current 15-minute period and periods 1-96.
Main	Returns to the WAN Card Main Screen.

ES

An Errored Second (ES) is a second with one or more CRC-6 (ESF) or BPV (D4/D-Frame) errors, one or more OOFs, or one or more Controlled Slips.

UAS

An Unavailable Second (UAS) is any second during which service is unavailable. An unavailable signal state is declared after ten consecutive Severely Errored Seconds (SESs) are logged. An unavailable state is cleared after ten consecutive non-Severely Errored Seconds are logged. Unavailable Seconds are also accumulated if the card has an out-of-service (OOS) condition.

SES

A Severely Errored Second (SES) is any second with 320 or more CRC-6 (ESF) or BPV (D4/D-Frame) errors, or one or more OOF errors.

BES

A Bursty Errored Second (BES) is any second with more than one and fewer than 320 CRC-6 (ESF) or BPV (D4/D-Frame) errors.

LOFC

The Loss of Frame Count (LOFC) is the accumulation of the number of times a Loss Of Frame (LOF) is declared. An LOF is declared after 2.5 seconds of continuous Loss Of Synchronization (LOS) or OOF condition. An LOF is cleared after no more than fifteen consecutive seconds without an LOS or OOF condition.

SLIP

A Slipped Second is any second containing one or more Controlled Slips. A Controlled Slip is the deletion or replication of a DS1 frame by the receiving equipment.

7.4.7 Test Screen

Pressing “t” (**Test** command) in the WAN Card Main Screen brings up the screen shown in Figure 7-20. From this screen, you can create test situations between WAN cards or between a single WAN card and data test equipment at a remote site. Table 7-14 lists the actions you can perform from the bottom line of this screen. Table 7-15 lists the settings controlled on this screen along with their possible values.

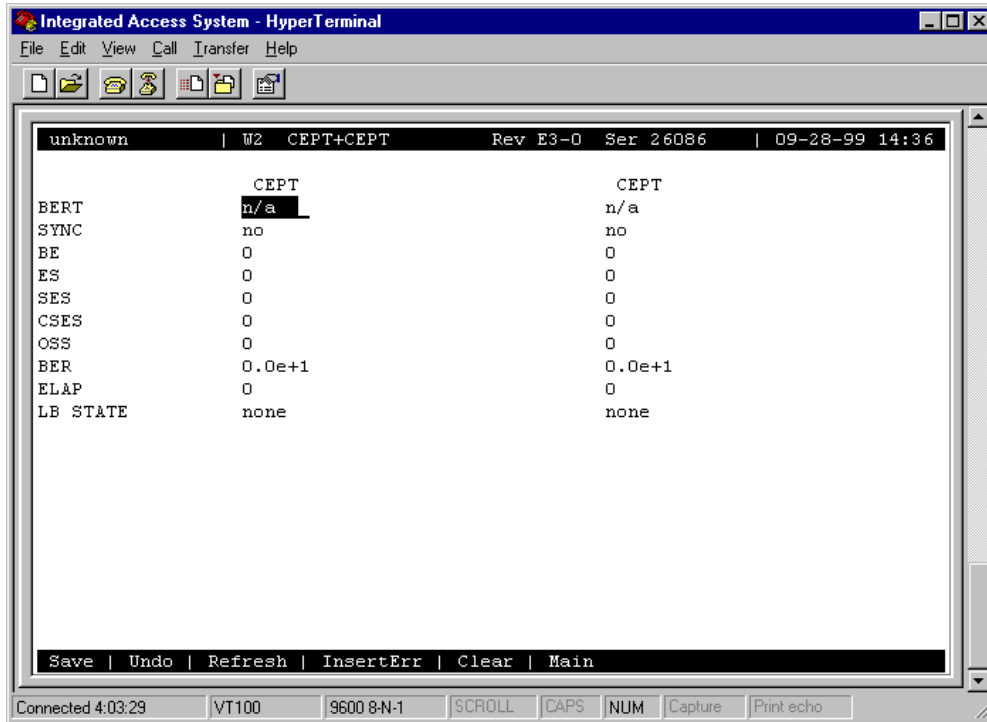

Figure 7-20. Typical WAN Card Test Screen

Table 7-14. Test Screen Actions

Action	Function
Save	Saves changes to settings.
Undo	Returns all settings to the last saved state.
Refresh	Updates certain time-related information fields that are not automatically updated (i.e., performance and test data).
Insert Err	Allows you to manually insert a single bit error into the data signal. This does not cause a CRC error.
Clear	Clears the Test Screen and resets all counters to zero.
Main	Returns to the WAN Card Main Screen. If changes are made to settings and not saved, you will be prompted to save or abandon those changes.

Table 7-15. WAN Card Test Screen Options

Parameter	User Options	Notes	Default
BERT	off mark space 1:1 1:7 3:24 qrss lp-up lp-dn	1	off
SYNC	information only—no user options		
BE	information only—no user options		
ES	information only—no user options		
SES	information only—no user options		
CSES	information only—no user options		
OSS	information only—no user options		
BER	information only—no user options		

ELAP	information only—no user options		
LB STATE	information only—no user options		

Notes:

1. The **lp-up** (loop-up) and **lp-dn** (loop down) codes are not supported for CEPT or HDSL WANs. Turning any of these tests on or off will cause a temporary interruption of data transmission on the DS0 time slots as well as on the FDL bit of the corresponding port.

BERT

The Bit Error Rate Tester (BERT) sends a data pattern and measures the bit error rate (BER) on the selected WAN port. The patterns that can be selected are **off**, **mark** (all ones), **space** (all zeros), **1:1** (0101), **1:7** (0100 0000), **3:24** (this pattern requires 3 bytes to display), **qrss** (quasi-random signal source), **lp-up** (which sends a T1 loop-up code to the remote end) and **lp-dn** (which sends a loop-down code to the remote end). The last two options are not available for WAN cards with CEPT or HDSL modules.

SYNC

The Synchronization (SYNC) field tells you if the integrated BERT has achieved synchronization either with itself via a remote loopback or with the remote test equipment. Since this is an information-only field, there are no user-selectable parameters.

BE

The Bit Error (BE) field shows the total number of bit errors logged. Since this is an information-only field, there are no user-selectable parameters.

ES

The Errored Seconds (ES) field shows the total number of seconds in which any errors were detected. Since this is an information-only field, there are no user-selectable parameters.

SES

The Severely Errored Seconds (SES) field shows the total number of seconds in which the bit error rate exceeded one bit per thousand (1×10^{-3}). Since this is an information-only field, there are no user-selectable parameters.

CSES

The Consecutive Severely Errored Seconds (CSES) field is triggered by the occurrence of ten consecutive Severely Errored Seconds. Once triggered, the CSES field will increment (by one) for each elapsed second until the system logs ten consecutive non-Severely Errored Seconds. Since this is an information-only field, there are no user-selectable parameters.

OSS

The Out of Synchronization Seconds (OSS) field shows the number of seconds that the WAN BERT has been out of synchronization. Since this is an information-only field, there are no user-selectable parameters.

BER

The Bit Error Rate (BER) field shows the rate at which errors are being logged. The system calculates BER by dividing the number of bit errors (BE) by the total number of bits transmitted during the test. Since this is an information-only field, there are no user-selectable parameters.

ELAP

The Elapsed time setting shows the running tally of the total number of seconds during the test. Since this is an information-only field, there are no user-selectable parameters.

LB STATE

The Loopback State setting changes when a WAN unit is both present and operational. This includes loopbacks caused by commands from remote devices as well as loopbacks caused by local settings. The field will show **plb** (payload loopback) when the entire signal, *excluding the framing bit*, is looped back. The field will show **llb** (line loopback) when the entire signal is looped back. It will show **none** if the WAN port is not in loopback.

7.4.8 Adtran E1/HDSL Screen

Figure 7-21 displays the Adtran E1/HDSL Screen for the WAN-U card. To go to this screen, press “**h**” (**Hdsl** command) in the WAN Card Main Screen. Table 7-16 lists the actions on the bottom line of this screen, and Table 7-17 shows the screen options and defaults.

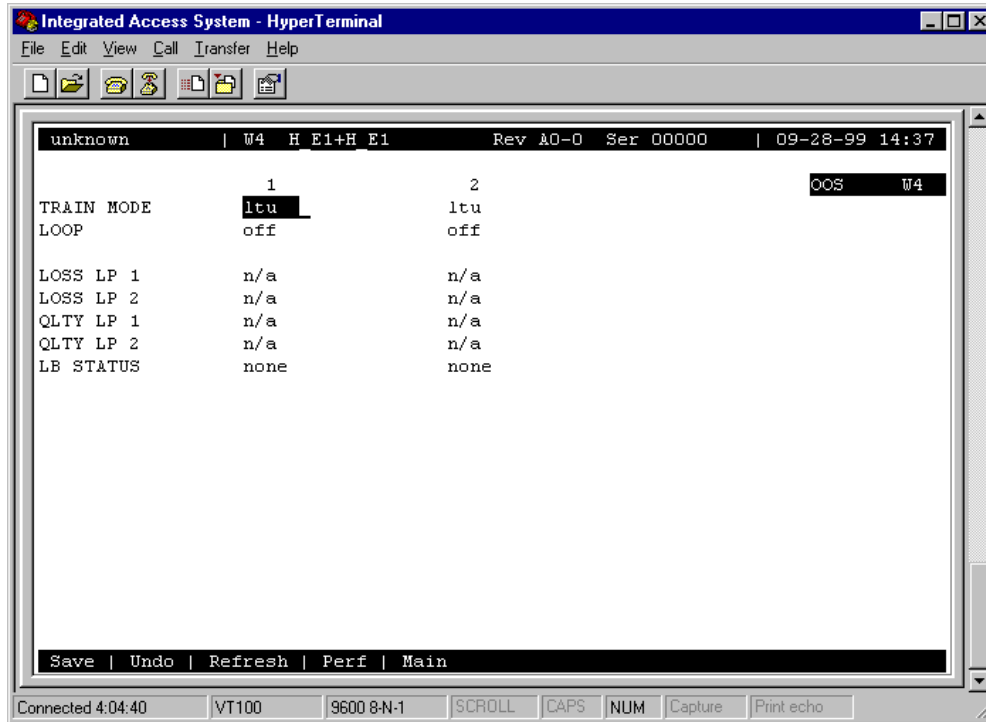

Figure 7-21. Typical Adtran E1/HDSL Screen

Table 7-16. Adtran E1/HDSL Screen Actions

Action	Function
Save	Saves changes to settings.
Undo	Returns all settings to the last saved state.
Refresh	Redraws the screen.
Perf	Brings up the HDSL Performance Data Screen (refer to HDSL section)
Main	Returns to the WAN Card Main Screen.

Table 7-17. Adtran E1/HDSL Screen Options and Defaults

Parameter	User Options	Default
TRAIN MODE	ltu ntu	ltu
LOOP	off r-loc r-net	off
LOSS LP 1	no user input	display only
LOSS LP 2	no user input	display only
QTTY LP 1	no user input	display only
QTTY LP 2	no user input	display only
LP STATUS	no user input	display only

TRAIN MODE

This parameter determines the master/slave relationship between the units. The setting for the central office master unit is **ltu** (default). Remote slave units should be set to **ntu**.

LOOP

This parameter sets loopbacks on the remote unit. Selecting **r-loc** will cause the remote link to loop back to the PCM buses of the remote unit. Selecting **r-net** will cause the remote link to loop back to the network. The default is **off**.

LOSS LP1

This number indicates the loss in loop 1 within ± 2 dB.

LOSS LP2

This number indicates the loss in loop 2 within ± 2 dB.

QLTY LP1

This parameter indicates the measure of signal quality correlated to noise margin in loop 1. Possible readouts are **loss** (no sync), or a number from **1** to **10**, where 10 is the best signal.

QLTY LP2

This parameter indicates the measure of signal quality correlated to noise margin in loop 2. Possible readouts are **loss** (no sync), or a number from **1** to **10**, where 10 is the best signal.

7.4.9 Adtran E1/HDSL Performance Data

Figure 7-22 shows the Adtran E1/HDSL Performance Data Screen for the WAN-U card. The screen will display statistics for either Unit 1 (HDSL module 1) or Unit 2 (HDSL module 2), depending on which one you choose in the HDSL Screen.

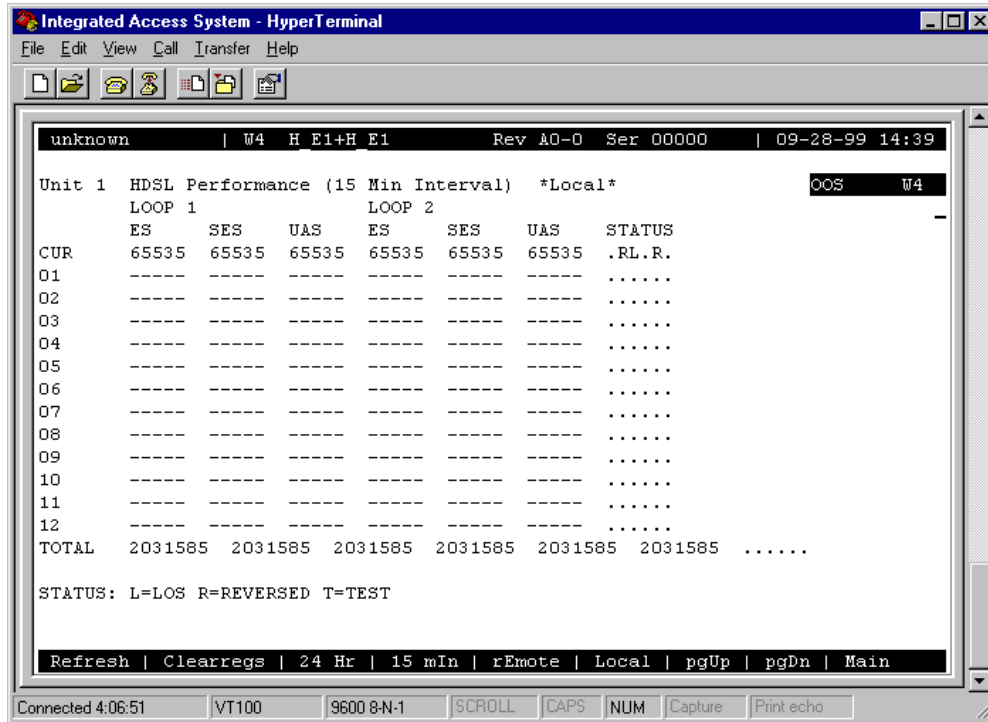

Figure 7-22. Typical Adtran E1/HDSL Performance Data Screen (local 15-minute interval)

Figure 7-22 shows the number of Errored Seconds (ES), Severely Errored Seconds (SES), and Unavailable Seconds (UAS) in loops 1 and 2 (local or remote), in either 15-minute or 24-hour increments. This allows for four different possible displays:

- 15-minute intervals, Local Loop (default)
- 15-minute intervals, Remote Loop
- 24-hour intervals, Local Loop
- 24-hour intervals, Remote Loop

You can alternate between screens by selecting from the actions at the bottom of the screen. When 15-minute intervals are active, pressing “**h**” (**24 Hr**) changes the display to 24-hour intervals (see Figure 7-23). Pressing “**i**” (**15 mIn**) in the 24-hour interval mode will go back to a 15-minute interval display. Similarly, press “**e**” (**rEmote**) in the Local screen to go to the Remote screen, and press “**l**” (**L**ocal) in the Remote screen to return to the Local screen.

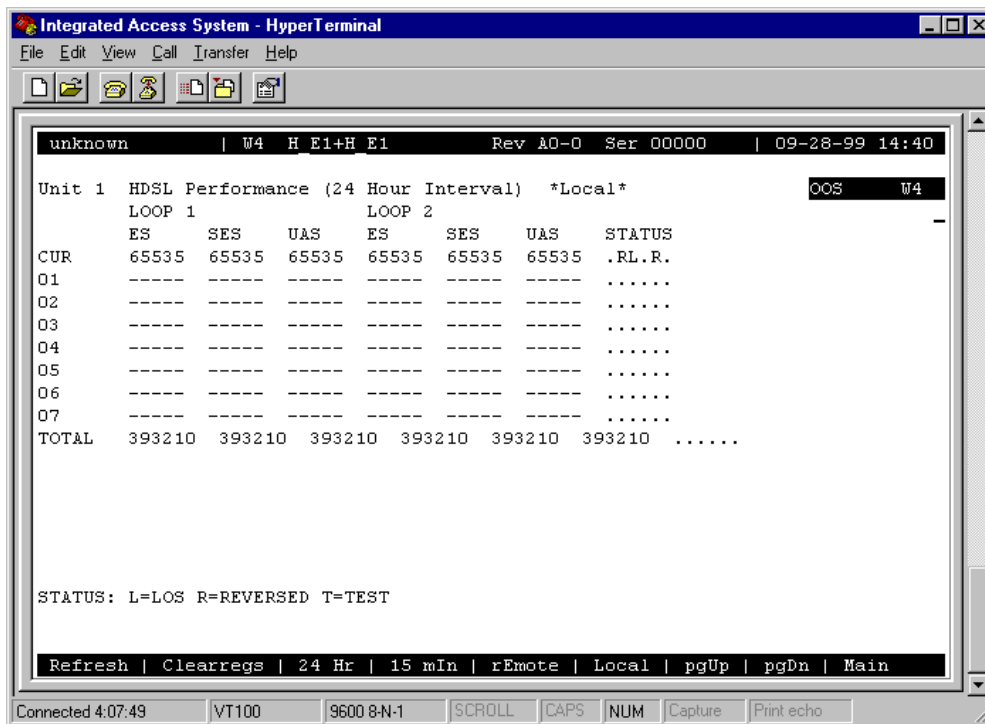

Figure 7-23. Typical Adtran E1/HDSL Performance Data Screen (remote 24-hour interval)

The only difference between the 15-minute and 24-hour screens is the historical time periods on the left side of the screen. In 24-hour intervals, seven historical times appear, as shown in Figure 7-23. This corresponds to the activity over the past seven 24-hour monitoring periods, thereby providing one week of historical data. These fields will be blank if monitoring has just begun.

In 15-minute intervals, 12 historical time periods are shown on the left side of the screen (Figure 7-22). By pressing “d” (**pgDn**) in that screen, you can view historical time periods 13 through 24. Press “d” again to display historical time periods 25 through 32. These periods record the activity for the past thirty-two 15-minute periods, thus providing eight hours of historical data.

Table 7-18 lists the actions available from the Adtran E1/HDSL Performance Data Screens. The register options are described below.

Table 7-18. Adtran E1/HDSL Performance Data Screen Actions

Action	Function
Refresh	Redraws the screen and updates information.
Clearregs	Clears the user registers and starts over.
24 Hr	Toggles to 24-hour interval monitoring.

15 mIn	Toggles to 15-minute interval monitoring.
REmote	Toggles to remote loop monitoring.
Local	Toggles to local loop monitoring.
PgUp	Scrolls up through historical intervals (n/a for 24 hour intervals).
pgDn	Scrolls down through historical intervals.
Main	Returns to the WAN Card Main Screen.

ES

An Errored Second (ES) is a second with one or more CRC-6 (ESF), BPV (D4/D-frame), or CRC-4 (E1) errors, **OR** one or more OOFs, **OR** one or more Controlled Slips.

SES

A Severely Errored Second (SES) is any second with 320 or more CRC-6 (ESF), BPV (D4/D-Frame), CRC-4 (E1) errors, or one or more OOFs.

UAS

An Unavailable Second (UAS) is any second during which service is unavailable. An unavailable signal state is declared after ten consecutive Severely Errored Seconds (SESs) are logged. An unavailable state is cleared after ten consecutive non-Severely Errored Seconds are logged. Unavailable Seconds are also accumulated if the card has an out-of-service (OOS) condition.

7.4.10 PairGain T1/HDSL Screen

Figure 7-24 displays the WAN T1/HDSL Screen for the WAN HDSL card with PairGain T1/HDSL modules. To go to this screen, press “**h**” (**Hdsl**) in the WAN Card Main Screen. Table 7-19 lists the actions on the bottom line of this screen, and Table 7-20 shows the screen options and defaults.

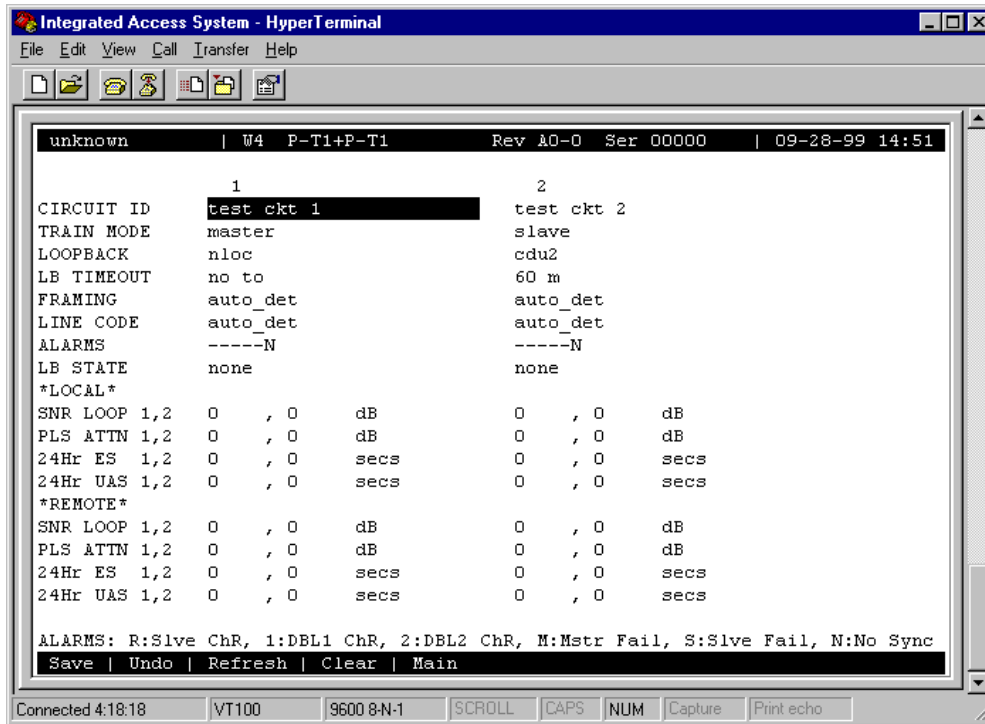

Figure 7-24. PairGain T1/HDSL Module Screen

Table 7-19. PairGain T1/HDSL Module Screen Actions

Action	Function
Save	Saves changes to settings.
Undo	Returns all settings to the last saved state.
Refresh	Redraws the screen.
Clear	Clears 24Hr ES and 24HR UAS
Main	Returns to the WAN Card Main Screen.

Table 7-20. PairGain T1/HDSL Module Screen Options and Defaults

Parameter	User Options	Default
CIRCUIT ID	Any combination of letters or numbers up to 24 characters, including spaces	*****
TRAIN MODE	slave master	slave
LOOPBACK	none nloc crem cloc nrem cdul CDU2 ndu1 ndu2	none
LB TIMEOUT	no to 20 m 60 m 120 m	no to
FRAMING	auto_detect unframed	auto_detect
LINE CODE	auto_detect b8zs ami	auto_detect
ALARMS	R:Slve ChR 1:DBL1 ChR 2:DBL2 ChR M:Mstr Fail S:Slve Fail N:No Sync	N:No Sync
LB STATE	read-only	read-only

LOCAL SNR LOOP 1,2 PLS ATTN 1,2 24Hr ES 1,2 24Hr UAS 1,2	read-only	read-only
REMOTE SNR LOOP 1,2 PLS ATTN 1,2 24Hr ES 1,2 24Hr UAS 1,2	read-only	read-only

CIRCUIT ID

A Circuit ID is defined as a group of one or more DS0 time slots cross-connected from one WAN link to another. Each circuit can carry either voice or data traffic, and needs its own name to facilitate cross-connect management within the system. The Circuit ID field allows you to name individual pass-through circuits. The Circuit ID can show any relevant title for the pass-through connection, although each circuit ID must be unique. This ID can contain up to 24 numbers, letters (uppercase and lowercase), and spaces, in any combination.

TRAIN MODE

This parameter determines the master/slave relationship between the units. The options are **master** or **slave**.

LOOPBACK

The available Loopbacks are listed in Table 7-21. The choices are: **nloc**, **crem**, **cloc**, **nrem**, **cd1**, **cd2**, **md1**, and **nd2**. At the “master” side, loopback detection can be configured to be with or without timeout, though it can not be turned off. When a module goes to local loopback (loc lb, nloc, or cloc) it transmits an AIS pattern toward the network, and when a “master” module goes to line loopback (crem) it transmits an AIS pattern toward the customer interface. The only exception is that when a “slave” module goes to line loopback (nrem) it transmits the signal from the network toward the customer interface and loop the network signal back to the master unit. (AIS pattern is NOT substituted for the original signal). Figure 7-25 and Figure 7-26 shows System Loopbacks.

Table 7-21. Available PairGain T1/HDSL Loopbacks

Name	Location	Toward
none	n/a	n/a
NLOC	Master OEM	Master
NREM	Slave OEM	Master
CREM	Master OEM	Slave
CLOC	Slave OEM	Slave
NDU1	Doubler 1	Master

NDU2	Doubler 2	Master
CDU1	Doubler 1	Slave
CDU2	Doubler 2	Slave

Loopbacks Toward Master
OEM Module (or HiGain HLU)

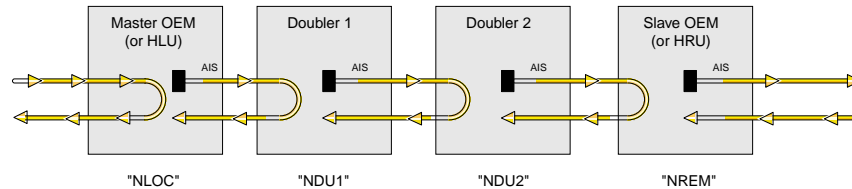

Figure 7-25. System Loopbacks towards Master Module

Loopbacks Toward Slave
OEM Module (or HiGain HRU)

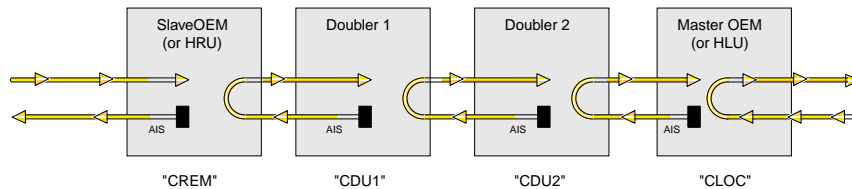

Figure 7-26. PairGain T1/HDSL System Loopbacks towards Slave Module

LB TIMEOUT

The Loopback Timeout parameter selects the minutes for loopbacks. The options are **no to** (no time), **20 m** (20-minutes), **60 m** (60-minutes) and **120 m** (120-minutes). These options are only available when the TRAIN MODE is set to master. If it is set to Slave the LB TIMOUT field is read-only.



Note: The LB TIMEOUT field may not be changed at the slave unit.

FRAMING

The Framing parameter selects the framing mode of the T1 framer on the PairGain module. The options are **auto detect** and **unframed**. In “**auto detect**” mode the PairGain framer switches to the framing mode of the local line. Note that the local lines (or the ACFA framer)

connected to the “master” and “slave” should always have the same framing mode. (e.g. both “esf”). Communication over the ESF DL bit is possible in “**auto detect**” mode as well as in “**unframed**” mode.



Note: The FRAMING field may not be changed at the slave unit.

LINE CODE

The Line Code parameter selects the line code of the PairGain module. The options are “**auto detect**”, “**b8zs**”, and “**ami**”. If the “LINE CODE” is selected as “b8zs” the ACFA framer is set to “b8zs” and if the “LINE CODE” is selected as “ami” the ACFA framer is set to “ami.”

The “auto detect” mode is useful when there is an NTU at the other end of the circuit. In “auto detect” mode the PairGain module switches to the line code of the local line. Note that in “auto detect” mode the local lines (or the ACFA framer) connected to the “master” and “slave” may have different line codings. When the “master” is set to “auto detect” or when the “slave” receives “auto detect” as its “LINE CODE” configuration the ACFA framer is set to “ami” line code.



Note: The LINE CODE field may not be changed at the slave unit.

ALARMS

The Alarms parameter informs the user of reversed channels or fatal hardware problems. Unlike in regular WAN cards where the TX (Transmit) at one end should be connected to the RX (Receive) at the other end for WAN HDSL (802060) card. Each loop should be connected to the same loop at the opposite end. If the channels are reversed, it will be indicated by this field and the modules will not sync. (R: channels reversed at Slave, 1: channels reversed at doubler1, 2: channels reversed at doubler2). This field is also used to indicate self test failure of the PairGain module at either end of the circuit, if this happens the card should be removed and reinserted. (M: self-test failed at Master, S: self-test failed at Slave).

During the first one minute that the PairGain modules have not synchronized yet and after that whenever the modules lose synchronization this field shows an alarm (N: No Sync).

LB STATE

The Loopback State setting changes when a WAN loopback is both present and operational. This includes loopbacks caused by commands from remote devices as well as loopbacks caused by local settings.

LOCAL

SNR (Signal to noise ratio), amount of PLS ATTN (Pulse Attenuation), 24 Hr ES (Errored Seconds) and 24 Hr UAS (Unavailable Seconds) are monitored for each loop for the local side. Note that these are read only parameters.

REMOTE

SNR (Signal to noise ratio), amount of PLS ATTN (Pulse Attenuation), 24 Hr ES (Errored Seconds) and 24 Hr UAS (Unavailable Seconds) are monitored for each loop for the remote side. Note that these are read only parameters.

7.5 PARS Screen

Figure 7-27 displays the PARS Screen for the WAN card in a T1 environment. To go to this screen, press “A” (pArs) in the WAN Card Main Screen. PARS (Premisys Automatic Rerouting System) feature is to protect the traffic of a failed T1 transmission line in a ring network. If a T1 line fails then PARS will provide protection to rerouting the traffic on that line. This means that all 24 time slots (totaling to the DS1 rate) will be completely protected.

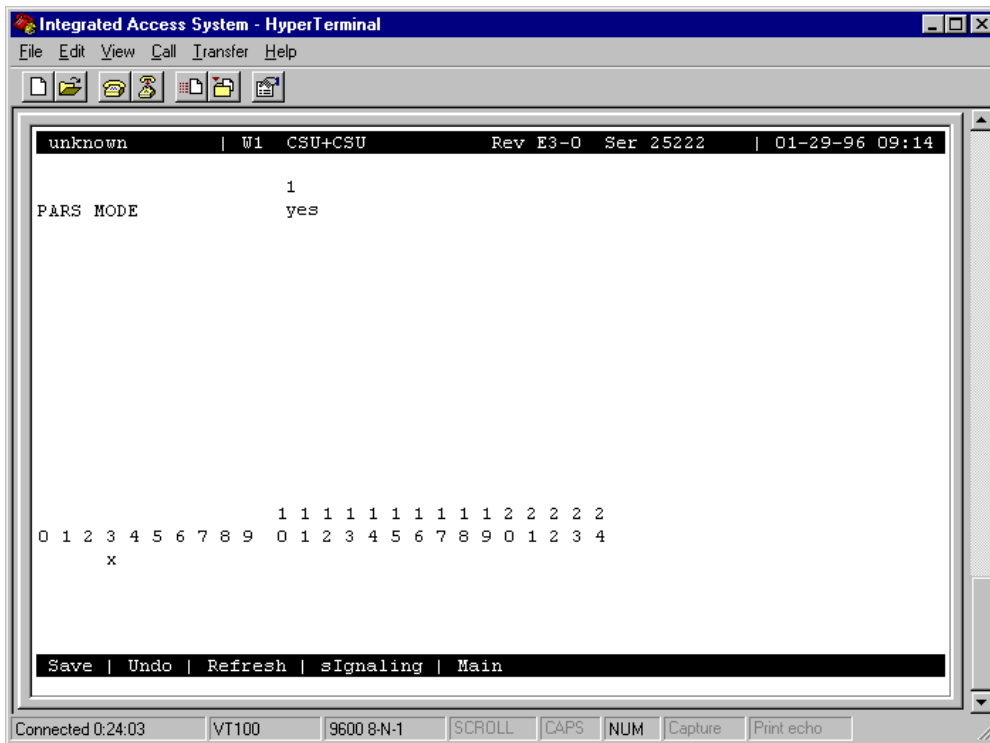

Figure 7-27. Typical T1 WAN PARS Screen

Table 7-22. T1 WAN PARS Screen Actions

Action	Function
--------	----------

Save	Saves changes to settings.
Undo	Returns all settings to the last saved state.
Refresh	Updates certain time-related information fields that are not automatically updated (i.e., performance and test data).
sIgnaling	Allows signaling for voice cards to be specified via a time slot map.
Main	Returns to the WAN Card Main Screen. If changes are made to settings and not saved, you will be prompted to save or abandon those changes.

Table 7-23. WAN Card Test Screen Options

Parameter	User Options	Default
PARS MODE	yes no	no

PARS must be made aware of the time slot(s) used by Voice cards terminated on a WAN. The “**sIgnaling**” menu option is used to do this. In Figure 7-27, PARS has been chosen from the WAN screen menu and then signaling has been displayed. Time slot #3 has been selected to show that it is in use by the Voice card terminated on this WAN.

Figure 7-28 shows an E1 WAN PARS screen. For E1 WANs, signaling is always carried on time slot #16 as indicated by the “S”. Time slot #5 has been selected using the “**sIgnaling**” option to show that it is in use by the Voice card terminated on this WAN.

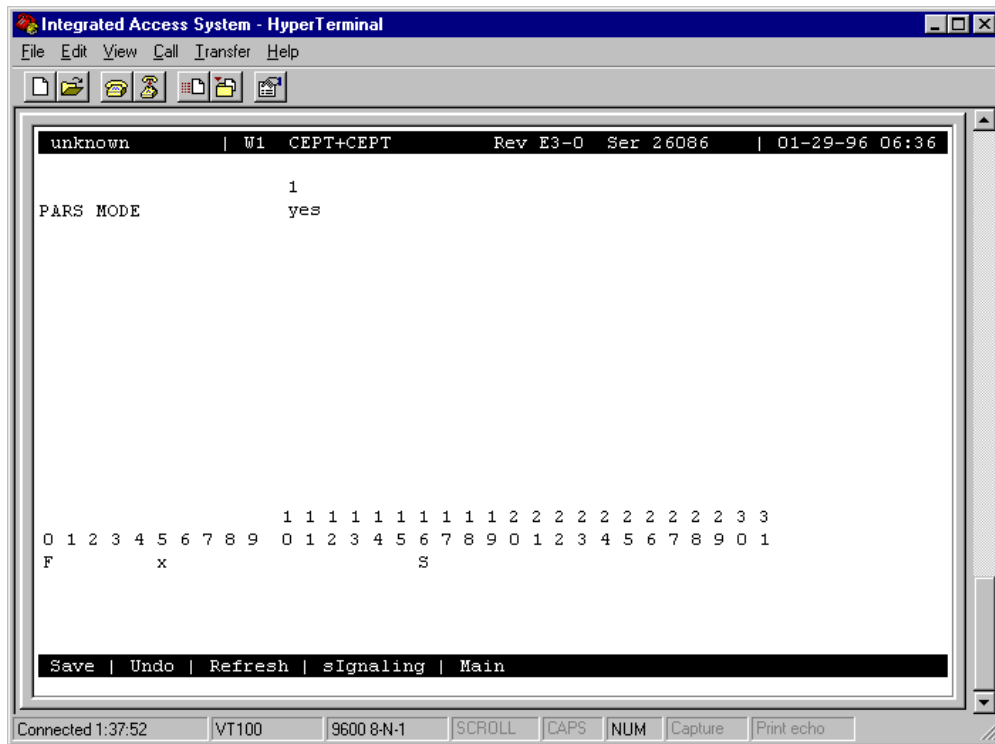

Figure 7-28. Typical E1 WAN PARS Screen

Figure 7-29 shows the WAN Cross-connect screen after PARS MODE has been selected. It monitors the time slot assignments between all time slots of the current WAN. The first column shows time slots on the current WAN. These time slots are cross-connected to the WAN and time slot listed in the second and third columns respectively.

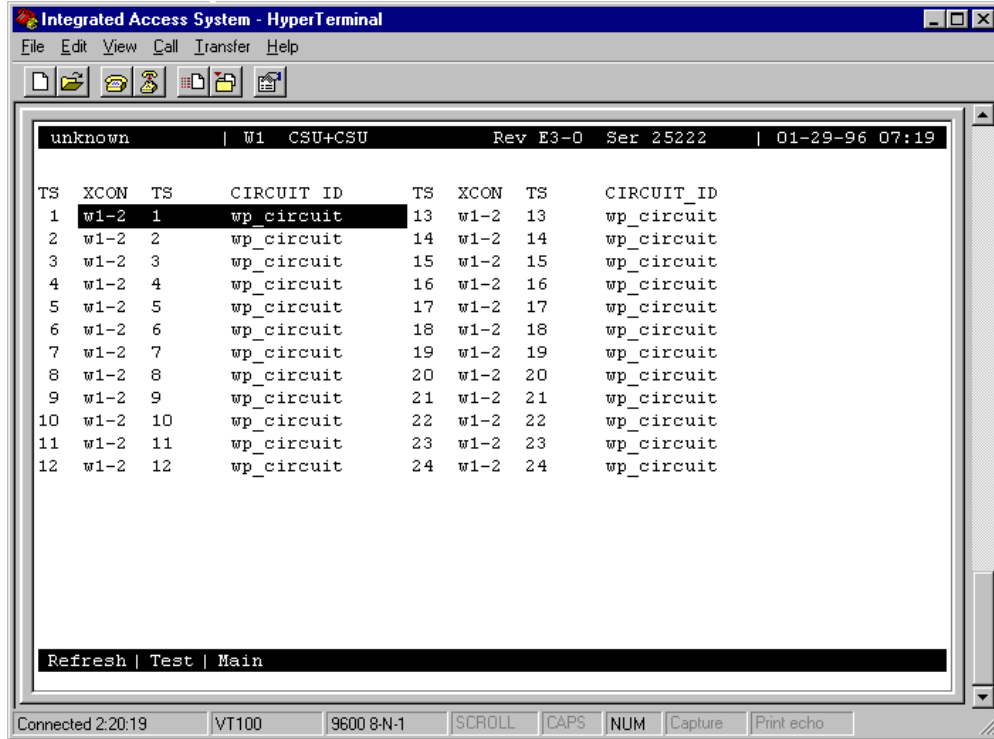

Figure 7-29. WAN Cross-Connect Screen

Figure 7-30 shows the System (Main) cross-connect screen after PARS MODE has been selected. This screen shows the result of the “View all” menu selection. The pars_circuit W/U field indicates that port #1 of a user card in slot U3 is terminated on WAN 1-1. The TS/BW column indicates that a single time slot on this port has been allocated. (To determine which time slot, see the time slot table on the user card screen). The pars_circuit TYPE field will vary with the user card type (voice or data). For example, terminating the FXS card would cause “v&s” to be displayed in this column while the HSU card would show “d”.

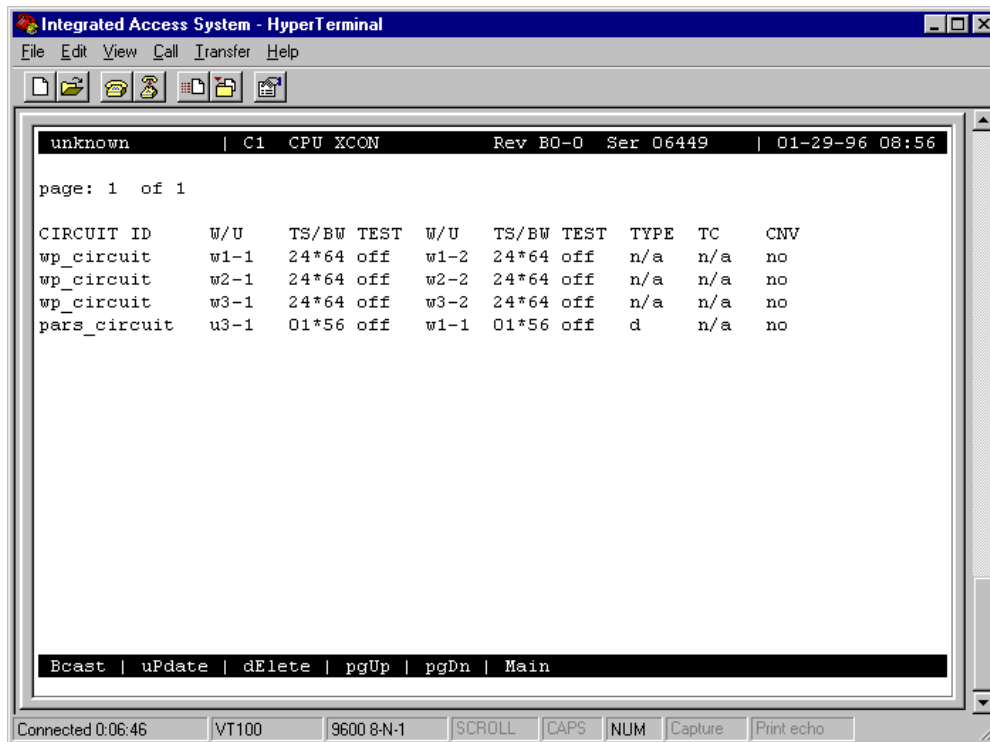

Figure 7-30. System (Main) Cross-Connect Screen in PARS MODE

7.5.1 Implementation of PARS

There are certain rules and guidelines to follow when PARS is implemented.

1. WAN should be empty (termination or time slot assignments) in order to turn PARS ON or Off.
2. As soon as PARS is selected on WAN #n, Wn-1 becomes primary and Wn-2 becomes secondary.
3. All primary time slots will be cross-connected to the secondary WAN.
4. Once a primary WAN is assigned to PARS mode, the secondary WAN will be assigned to PARS by the system and will not be available to the user. Nothing can be terminated on a secondary WAN after PARS MODE is selected.
5. Physical connections are always made from the secondary WAN to the primary WAN of the adjacent node.
6. User cards will be terminated normally on the primary WAN.

7. Upon termination on the primary WAN, user cards will actually be split so that they are terminated on RX of one WAN and TX of the other.
8. WAN will work as usual until CGA-RED or CGA-YELLOW is detected. The TX and RX of empty time slots will be cross-connected to themselves. User cards will be cross-connected to the WAN with the unbroken link and their split termination between the two WANs will be removed.

7.5.2 Ring Network Traffic Flow

Figure 7-31 below, shows Ring Network Traffic Flow under normal conditions. The traffic flow in the ring is as follows:



Note: IAD is an example for any type of Integrated Access System used in the field.

- IAD 1 traffic to IAD 3 goes through IAD 2
- IAD 1 traffic to IAD 4 goes through IAD 2, and IAD 3
- IAD 1 traffic to IAD 5 goes through IAD 2, IAD3, and IAD 4
- and so on for traffic flow from IAD 2, IAD 3, IAD 4, and IAD5

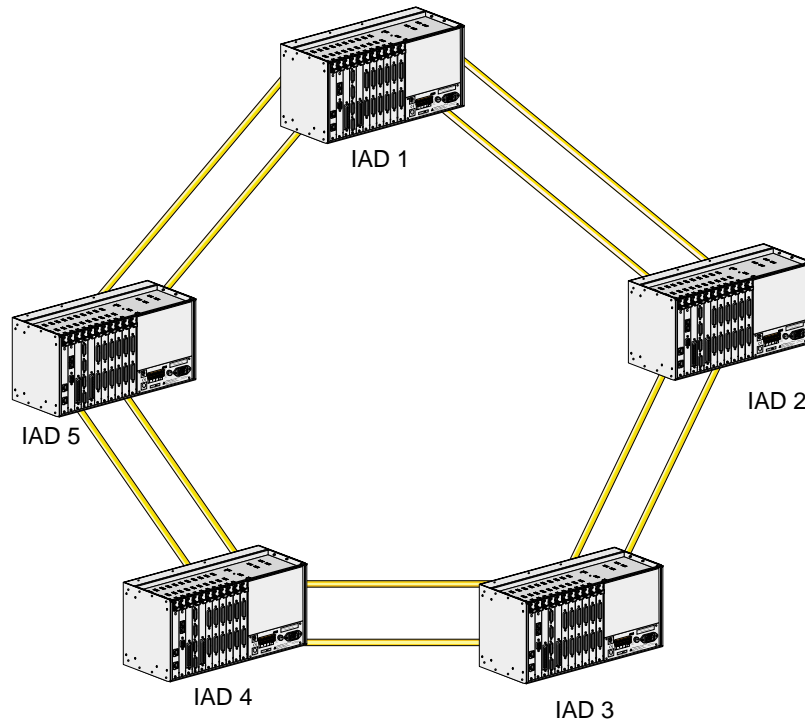

Figure 7-31. Ring Network Traffic Flow

7.5.3 One Link is Lost

If the link from IAD 1 to IAD 2 fails, then the traffic is rerouted as illustrated in Figure 7-32.

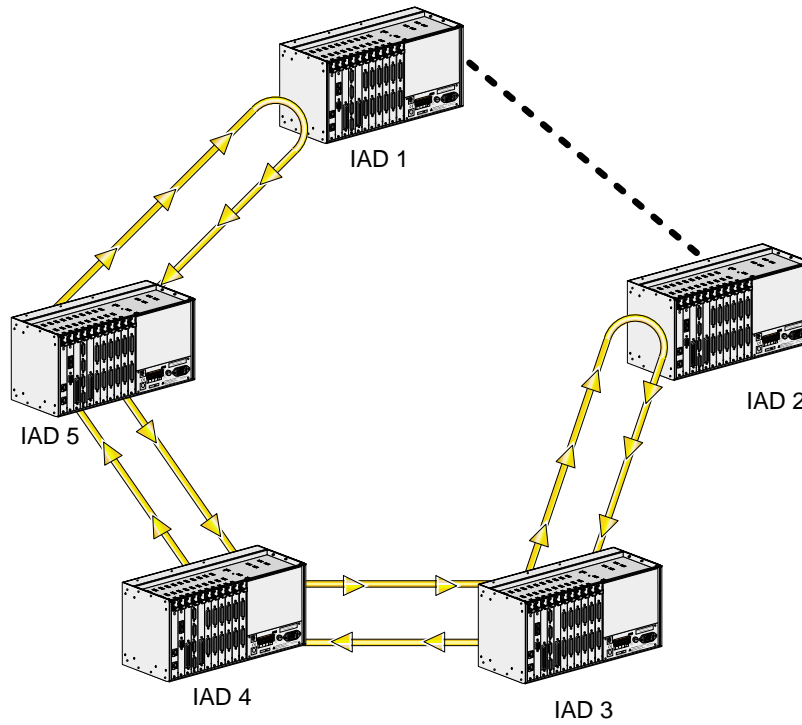

Figure 7-32. Traffic Flow when One Link is Lost

7.5.4 Two Links are Lost, One IAD is Isolated from the Ring

If the link from IAD 1 to IAD 2, and the link from IAD 2 to IAD 3 fail, then the traffic is rerouted as illustrated in Figure 7-33.

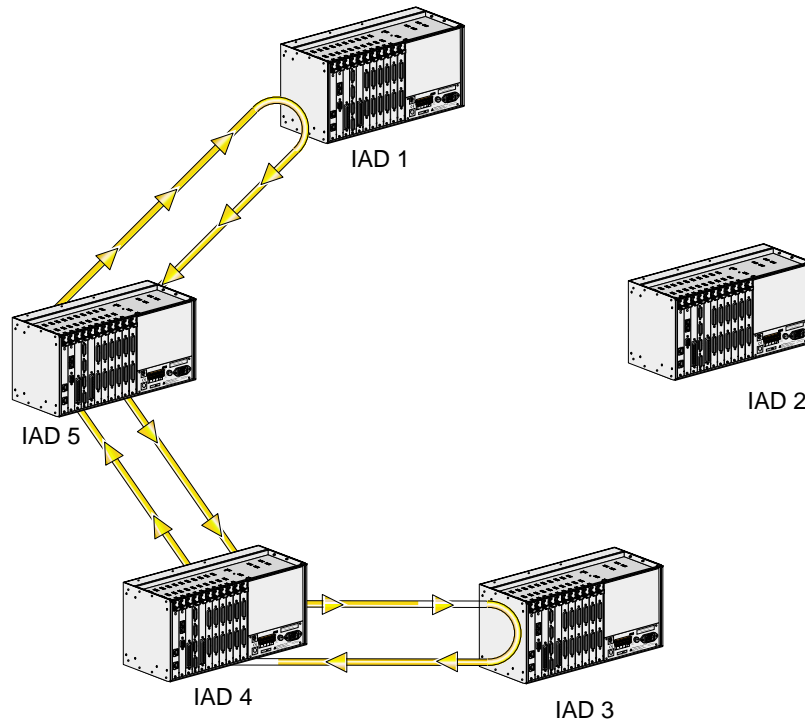

Figure 7-33. Traffic Flow when two Links are Lost (One IAD is Isolated)

7.5.5 Two Links are Lost, Two IADs are Separated from the Ring

If the link from IAD 1 to IAD 2, and the link from IAD 4 and IAD 5 fail, then the traffic is rerouted as illustrated in Figure 7-34.

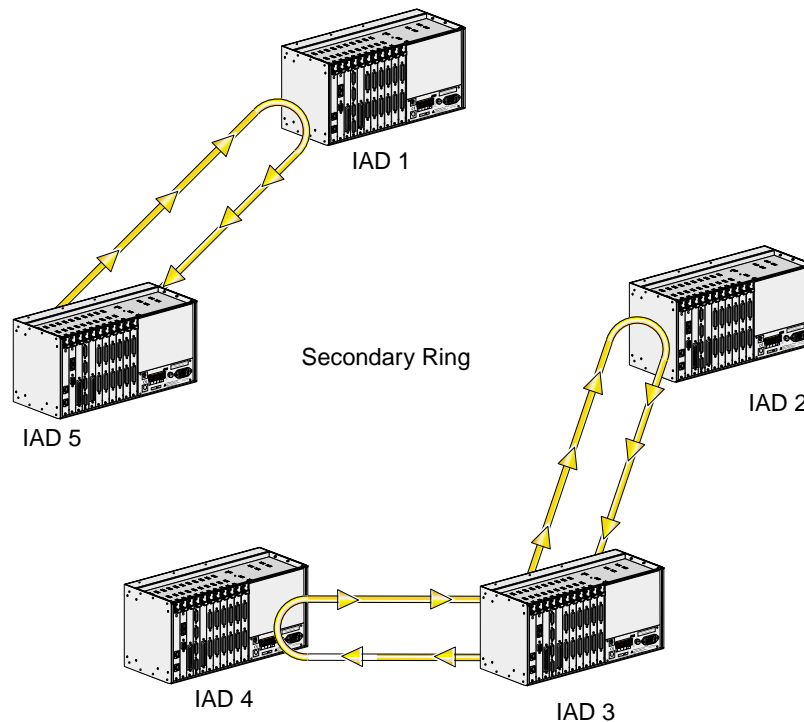

Figure 7-34. Traffic Flow when two connected IADs are separated from the Ring

7.5.6 Integrated Access Device Functionality

In order to offer PARS feature, the integrated access device will perform the following functions:

The integrated access device will provide a receive side and transmit side option to voice and data Channels and WAN time slots. It will differentiate between transmit side and receive side of each time slot/channel (voice or data). This is done internally and is not visible to the user.

The integrated access device will designate the received side of a link either active or inactive and the transmit side of a link active or inactive. This is done internally and is not visible to the user.

7.5.7 Normal Operation - No Link Failure

Any of the WAN lines in a cross-connect integrated access device can be assigned to PARS mode. Once a WAN (W1-1 for example) is assigned to PARS mode, the other WAN of that card (i.e. W1-2) will be assigned to PARS by the system and will not be available to the user. The user assigned WAN will become primary and the system assigned WAN will become the secondary. The WAN line time slots must be unassigned (and free prior to PARS mode

configuration). Otherwise, the system will not accept the PARS mode. When W1-1 is assigned to PARS mode, the system will cross-connect all its time slots to the W1-2 time slots. This is illustrated in Figure 7-35.

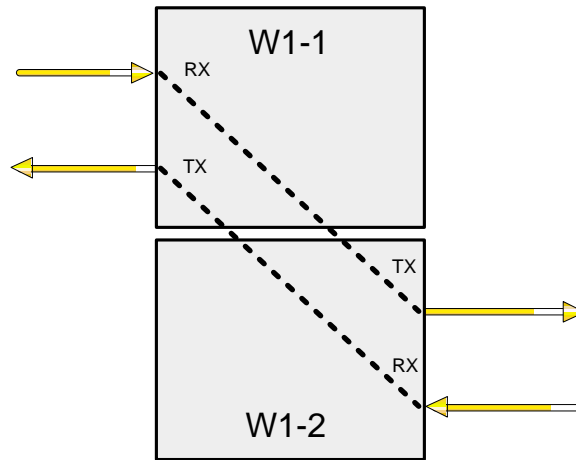

Figure 7-35. PARS Time slot Cross-connection between Primary and Secondary WANs

Figure 7-36 shows user card termination in PARS mode. Time slots assigned to the user card are split between primary and secondary WANs.

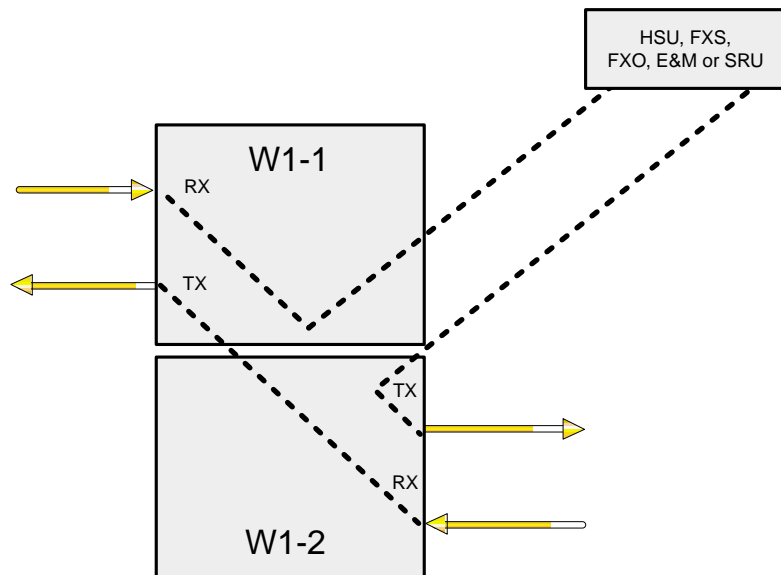

Figure 7-36. User Card Termination on PARS WAN

A four node configuration operating in PARS mode is illustrated in Figure 7-37. In this configuration one user port per node is used for the purpose of illustration. In node one the transmit of all 24 time slots of W1-1 are cross-connected to the receive of all 24 time slots of W1-2. The receive of 23 time slots of W1-1 are cross-connected to the transmit of 23 time slots of W1-2. The HSU transmit is connected to the receive of one of the W1-1 time slot and its receive is connected to the transmit of the corresponding time slot of W1-2. Similar connections are made in the rest of the nodes.

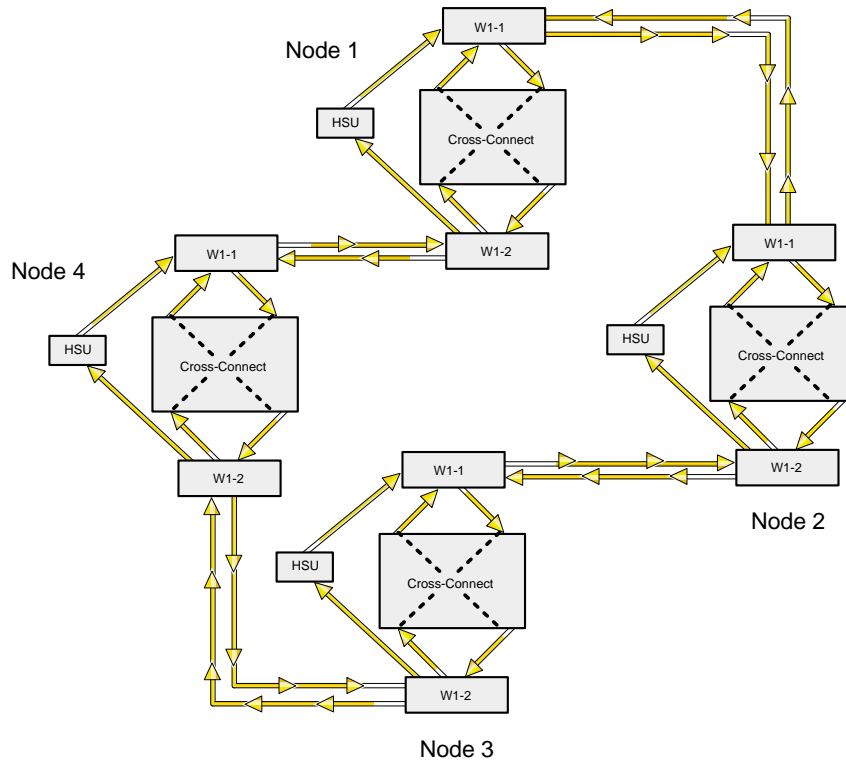

Figure 7-37. PARS Normal Operation Mode using four IAD Nodes

7.5.8 Line Protection - Link Failure

When WAN links fail, the ring will break. The integrated access device will stop delivering traffic to the broken links and will reroute the traffic through the ring and loop them before the broken lines.

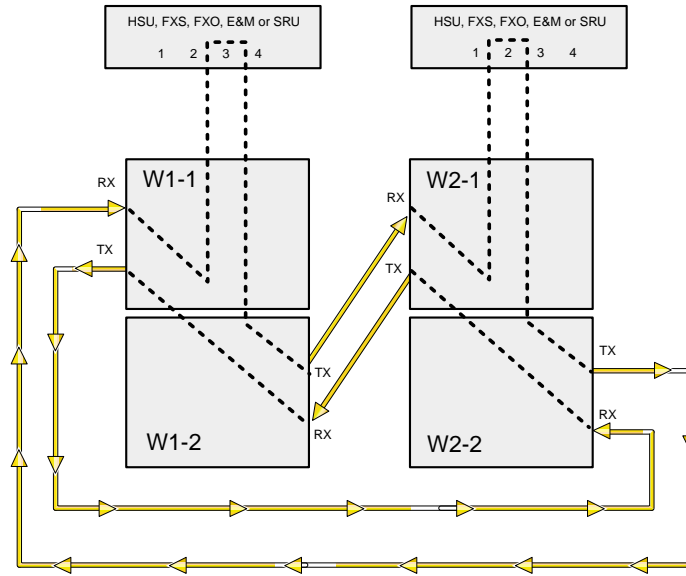

Figure 7-38. PARS Normal Operation Mode (two nodes)

Figure 7-38 shows details of PARS mode for two nodes. Primary WANs are cross-connected to secondary. User cards appear to be terminated normally on the primary WAN. They are actually split between RX of the primary and TX of the secondary, as shown. Note that the physical connections between nodes are shown from the secondary WAN of one node to the primary WAN of the adjacent node.

Figure 7-39 shows detail of PARS mode for two nodes with the link between adjacent nodes broken. Time slots have been rerouted and any User card terminated on the failed WAN has been assigned to the WAN with the unbroken link. Note that on WAN card number 2 a User card was terminated on the primary WAN (actually split) and is rerouted to the secondary WAN after the primary received an alarm. Data is transmitted around the ring in the “opposite” direction in order to reach the destination node. This detail applies to systems with multiple nodes as illustrated in Figure 7-34.

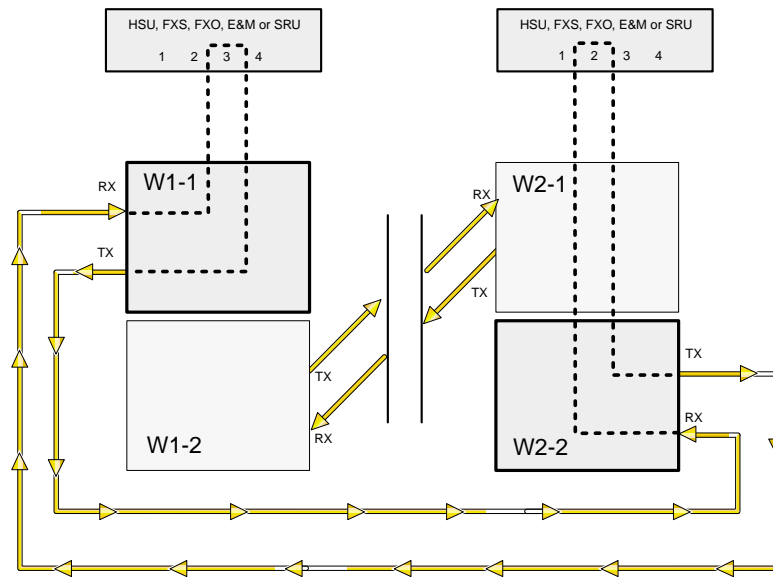

Figure 7-39. PARS Rerouting (two nodes)

7.6 WAN Card Error Messages

Refer to Appendix B in the System Reference Guide for further information on Error Messages regarding this card.

7.7 WAN Card Troubleshooting

The WAN card (or a T1 or E1 port on it) may be faulty if a CGA-Red alarm is in progress on either port of the card. This alarm occurs if the incoming network signal is lost, or if the WAN port is out of frame with that signal. To isolate the trouble, proceed as follows:

1. See if similar alarms are also present on any other T1/E1 lines and WAN cards in the system. If so, the trouble may be with the Interface card, which connects the T1 and E1 signals from the WAN cards to the external network. If the trouble is only on one T1 or E1 line connected to the WAN card, continue with step 2.
2. Perform a local T1 or E1 signal loopback toward the CPE, and see if the CGA alarm clears after about 10 to 30 seconds. If it does, the WAN card is good; go to step 3. Otherwise, go to step 4.
3. Check the local network equipment receiver, cabling to the Interface card at the local system, and the far-end system or network transmitter.

4. Replace the WAN card with an identical WAN card. Be sure to install the same types of plug-in modules on the new WAN card before plugging it in.
5. If the WAN card is determined to be faulty, replace it and return the faulty unit for repair to the location specified by your distributor.

7.8 WAN Card Specifications

WAN Cards (Models 800060, 801060, 801160, 801460 and 801560 T1/E1)				
Physical				
Model	Number of Ports	Number of Cards	Physical I/F	Electrical I/F
800060	1	1 to 4	Through 892x I/F card	81130 (T1-DSX/E1-CEPT) 81200 (T1-CSU) - 1 per port
801060, 801460, 801560	2	1 to 4	Through 892x I/F card	81130 (T1-DSX/E1-CEPT) 81200 (T1-CSU) - 1 per port
801160	2	1 to 4	Through 892x I/F card	820 2*1168kbps HDSL Module
Performance and Test Options				
Loopbacks		Line, Local Channel, Loopback Generation and Detection, ESF (8015 only)		
T1		FDL in accordance with AT&T 54016 or ANSI T1.403		
E1		National Bit Supporting (G.704)		
T1/DSX Interface				
Bit Rate and Tolerance		1.544Kbps + 32 ppm		
No. of T1 WAN Links per module		1		
Max. No. per WAN card		2		
Electrical Interface		Per ANSI T1.102/T1.403, DSX-1 100 ¹ / ₂ balanced		
Transmission Range		Software Selectable: 0, 133, 266, 499, 533 or 655 ft. (200 m), csu (csu - allows connection to the equipment side of a co-located external CSU over a short-distance, four-wire cable)		
Line Coding		Software Selectable AMI or B8ZS		
Frame Format		Software Selectable - D4, ESF, SLC 96, Subscriber Loop Carrier D4		
D4 Framing		Normal Superframe		
ESF Framing		Extended Superframe		
Subscriber Loop Carrier 96		As per TR-TSY-000008 Mode 1 Supports logical shelf A, logical shelf B or logical shelf group AB only Supports POTS, CLASS services, CENTREX services, Loop and Ground Start FXS and FX trunks and DID circuits Does not support Multi-Party or Coin Phone lines		
Subscriber Loop Carrier D4		Supports SP/UVG signaling Supports shelf group B only		
Voice Channel Signaling		AT&T PUB 43801, AT&T 62411, ITU-T Q.421, Q.422 using Robbed-bit method		
Error Detection				
Frame Format		Error Scheme		
ESF		CRC-6, Controlled Slip, Out of Frame		

D4, SLC96, SLCD4	BiPolar Violation, Controlled Slip, Out of Frame
Alarm Indication	As per Bellcore TR-TSY-000191
SLIP Limit	Software Selectable: 126 bits or 138 bits
Equalization	Software Selectable: Adjustable line build out (LBO) settings for 133, 266, 399, 533, 655 ft. csu (CSU option provides connection to equipment side of co-located external CSU)
Power Levels	Complies with ANSI T1.403 and ITU-T G.703
Output Jitter	Complies with ITU-T G.824
Input Jitter and Wander	Complies with ITU-T G.824

CSU Interface	
Bit Rate and Tolerance	1.544 Mbps + 32 ppm
No. of T1 WAN Links per module	1
Max. No. per WAN card	2
Electrical Interface	Per ANSI T1.102/T1.403, DSX-1 100 ^{1/2} balanced
Transmission Range	Software Selectable - 0 dB, 7.5 dB, 15 dB 3000 feet to 6000 feet with 40 dB cable loss (@ 5000 ft. or 1500 m) Actual range depends on cable characteristics although software selectable ranges of 0 dB, 7.5 dB and 15 dB are provided. (0 - allows connection to the network side of a co-located external CSU over a short-distance, four-wire cable)
Line Coding	Software Selectable AMI or B8ZS
Frame Format	Software Selectable - D4, ESF, SLC96, Subscriber Loop Carrier D4
D4 Framing	Normal Superframe
ESF Framing	Extended Superframe
Subscriber Loop Carrier 96	As per TR-TSY-000008 Mode 1 Supports logical shelf A, logical shelf B or logical shelf group AB only Supports POTS, CLASS services, CENTREX services, Loop and Ground Start FXS and FX trunks and DID circuits Does not support Multi-Party or Coin Phone lines
Subscriber Loop Carrier D4	Supports SP/UVG signaling Supports shelf group B only
Voice Channel Signaling	AT&T PUB 43801, AT&T 62411, ITU-T Q.421, Q.422 using Robbed-bit method
Error Detection	
Frame Format	Error Scheme
ESF	CRC-6, Controlled Slip, Out of Frame
D4, SLC96, SLCD4	BiPolar Violation, Controlled Slip, Out of Frame
Alarm Indication	As per Bellcore TR-TSY-000191
SLIP Limit	Software Selectable: 126 bits or 138 bits
Equalization	Software Selectable with settings for 0, 7.5 or 15.0 dB
Power Levels	Complies with ANSI T1.403 and ITU-T G.703
Output Jitter	Complies with ITU-T G.824
Input Jitter and Wander	Complies with ITU-T G.824

E1 Interface	
Bit Rate and Tolerance	2.048 Mbps \pm 50 ppm
No. of E1 WAN Links per module	1
Max. No. per WAN card	2
Electrical Interface	G.703 balanced 120 W or unbalanced 75 W Prior to Rev F0 - Jumper Selectable: 75 _{1/2} unbalanced or 120 _{1/2} balanced. Rev F0 and above - Jumper Selectable: 75 _{1/2} unbalanced or 120 _{1/2} balanced. (Balanced mode operation may be achieved via the 1183 or 1184 Distribution Panel).
Transmission Range	2.0 km on 22 AWG
Line Coding	High Density Bipolar of order 3 (HDB3)
Frame Format	ITU-T G.704 - Double Frame or CRC-4 Multiframe Format
Signaling	If voice signaling is required, it is transported in time slot 16 Software Selectable: cAS, CCS or none CAS Signaling Protocols: AT&T 43801, AT&T 62411, ITU-T Q.42
Signaling Channels	ITU-T G.704 supporting ABCD signaling
Error Detection	CRC-4, Controlled Slip, Out of Frame
Alarm Indication	ITU-T G.732
Pulse Shape	Per G.703 Figure 15 (1991)
Pulse Amplitude	Per G.703 Table 6 (1991)

	75_{1/2} unbalanced	120_{1/2} balanced
mark/pulse	2.37 V	3 V
space/no pulse	0 \pm 0.237	0 \pm 0.3 V

Nominal Pulse Width	244 ns
Output Jitter	As per G.823
Input Jitter and Wander	As per G.823

E1 HDSL Interface	
Bit Rate and Tolerance	E1 rate: 2.048 Mbps \pm 50 ppm
No. of E1 WAN Links per module	1
Max. No. per WAN card	2
Electrical Interface	ETR 152
Line Coding	2B1Q
Distance	9000 Ft. of 26 Gauge cable (2.7 km) or 12000 Ft. of 24 Gauge (4.5 km) (Tolerates 2 Bridge taps and will support a BER of 10 ⁻⁷ or better over these cable distances.)
HDSL Transmit Signal Level	13.5 dBm
Frame Format	ITU-T G.704 - Double Frame or CRC-4 Multiframe Format
Voice Channel Signaling	If voice signaling is required, it is transported in time slot 16 software selectable CAS CCS or none CAS Signaling Protocols: AT&T 43801, AT&T 62411, ITU-T Q.421
Signaling Channels	ITU-T G.704 supporting ABCD signaling
Error Detection	CRC-4, Controlled Slip, Out of Frame
Alarm Indication	ITU-T G.732

Standards Compatibility		
AT&T	TR43801	Digital Channel Bank Requirements and Objectives
	TR54016	Requirements for Interfacing Digital Terminal Equipment to Service Employing the Extended Superframe Format
	TR62411	Accunet 1.5 Service, Description and Interface Specifications
Bellcore	TR-TSY-000008	Digital Interface Between the SLC 96 Digital Loop Carrier System and a Local Digital Switch (Issue 2 08/87)
	TR-TSY-000191	Alarm Indication Signal, Requirements and Objectives
	GR-63-CORE Issue 1	Network Equipment-Building System (NEBS) Requirements: Physical Protection
ANSI	T1.101	Synchronization Interface Standards for Digital Networks
	T1.107	Digital Hierarchy - Formats Specifications
	T1.403	ISDN, Network-to-Customer Installation -DS1 Metallic I/F
	T1.408	ISDN Primary Rate
ITU-T	G.703	Physical/Electrical Characteristics of Hierarchical Digital I/F
	G.704	Synchronous Frame Structure Used At Primary and Secondary Hierarchical Levels
	G.732	Characteristics Of Primary PCM Multiplexed Equipment Operating at 2048 Kbit/sec.
	G.735	Characteristics Of Primary PCM Multiplexed Equipment Operating at 2048 Kbit/sec. and Offering Synchronous Digital Access at 384 Kbit/sec. and/or 64 Kbit/sec.
	G.736	Characteristics of A Synchronous Digital Multiplex Equipment at 2048 Kbits/sec.
	G.823	The Control of Jitter and Wander Within Digital Networks which are based on the 2048 Kbits/sec Hierarchy.
	G.824	The Control of Jitter and Wander Digital which are based on the 1544 Kbits/sec Hierarchy.
	Q.421	Digital line signaling code
	Q.422	Clauses for exchange line signaling equipment
ETSI	ETR 152	Reference: RTR/TM-03036 - Transmission and Multiplexing (TM); High bitrate Digital Subscriber Line (HDSL) transmission system on metallic local lines; HDSL core specification and applications for 2048 kbit/sec. based access digital sections including HDSL dual-duplex Carrierless Amplitude Phase Modulation - Edition 2 1995-06 - 158 Pages
UL/CSA	UL 1950	UL Standard for Safety of Information Technology Equipment
	C22.2, No. 950	Safety of information technology equipment including electrical business equipment.
CEN	EN 50 081-1	Electromagnetic compatibility generic emission Part 1 Residential, commercial and light industry.
	EN 50 082-1	Electromagnetic compatibility generic immunity standard Part 1 Residential, commercial and light industry.
	EN 60 950/A2	Safety of information technology equipment including electrical business equipment.

Chapter 8

System Testing and Diagnostics

8.1 Introduction

This chapter describes the Integrated Access Systems' comprehensive set of built-in diagnostic tools that enable the operator to remotely troubleshoot and resolve problems. Throughout the user card chapters in this system reference guide are brief explanations of system testing and problem solving. However this chapter was designed to provide a "full picture" of what this Integrated Access System is capable of providing.

8.2 Integral Test Capabilities

The Integrated Access System provides diagnostics capabilities to resolve problems. There are system-generated alarm messages described in *Chapter 4. System Configuration and Operation*, the integral diagnostics capabilities of this system include Bit Error Rate Testers (BERTs) on data cards, tone generators on analog voice cards, the ability to manipulate the analog leads and the digital signaling bits of voice circuits and extensive loopback generation and detection capability on many system elements.

The ability to initiate loopbacks at various points in a circuit, coupled with the ability to generate and receive test signals and to collect performance and error information, enable the operator to systematically troubleshoot circuit problems. It allows the operator to determine if the problem resides in the system, and whether the problem can be isolated down to a specific Field Replaceable Unit (FRU) within the system. Since all of these diagnostic tools can be operated from a remote VT100 terminal, troubleshooting begins immediately without dispatching an on-site technician.

8.3 User Card Diagnostics

8.3.1 WAN Diagnostics

Software-initiated diagnostics on T1 and E1 WAN aggregates include looping the WAN signal toward the network (line loopback) or the system (local loopback) and placing any one of the DS0 channels that make up the WAN signal in local loopback. The table below list detailed information on the diagnostic capabilities of the WAN cards.

Loopbacks	T1/CSU	T1/DSX	E1/CEPT/HDSL
On-Card loopbacks			
T1/E1 Line loopback Toward Network	Yes	Yes	Yes
T1/E1 Local loopback Toward User	Yes	Yes	Yes
DS0 Channel loopback Toward Network	No	No	No
DS0 Channel loopback Toward User	Yes	Yes	Yes
In-Band loopback Code Generation			
Industry-Standard T1/E1 Loop-Up Code	Yes	Yes	N/A
Industry-Standard T1/E1 Loop-Down Code	Yes	Yes	N/A
In-Band loopback Code Detection			
Industry-Standard T1/E1 Loop-Up Code	Yes	Yes	N/A
Industry-Standard T1/E1 Loop-Down Code	Yes	Yes	N/A
Bit Error Rate Tester (BERT)			
Patterns Supported			
All 1s	Yes	Yes	Yes
All 0s	Yes	Yes	Yes
1:1	Yes	Yes	Yes
1:7	Yes	Yes	Yes
511	No	No	No
2047	No	No	No
3:24	Yes	Yes	Yes
QRSS	Yes	Yes	Yes
BERT Direction			
Toward User	No	No	No
Toward Network	Yes	Yes	Yes
Statistics Gathered by BERT			
Bit Errors (BE)	Yes	Yes	Yes
Errored Seconds (ES)	Yes	Yes	Yes
Severely Errored Seconds (SES)	Yes	Yes	Yes
Consecutive Severely Errored Seconds	Yes	Yes	Yes
Out of Synchronization Seconds (OOS)	Yes	Yes	Yes
Bit Error Rate (BER)	Yes	Yes	Yes
Elapsed Seconds (ELAP)	Yes	Yes	Yes
HDSL Errored Seconds	N/A	N/A	Yes*
HDSL Severely Errored Seconds	N/A	N/A	Yes*
HDSL Unavailable Seconds	N/A	N/A	Yes*



Note: *Applicable only for the E1-HDSL plug-in module. Also the same statistics are available for the remote end.

8.3.2 Voice Diagnostics

The software-initiated diagnostics supported are voice cards include the setting of both analog and digital loopbacks toward the network and the generation of Quiet Tone and a Digital MilliWatt signal on a port-by-port basis. The operator can also monitor and set the state of the analog leads of any FXS, FXO or E&M port. They can set and monitor the state of the ABCD signaling bits of the digitized voice signal. In cross-connect system, test functionality also includes the ability to generate test tones (300Hz, 1 kHz and 3 kHz) and transmit those toward the user side or the network side of the system. The table below shows detailed information on the diagnostic capabilities of the Voice cards.

	2-wire E&M	4-wire E&M	4-wire Extended E&M	2-wire FXS	2-wire FXO
On-Card loopbacks					
Analog Toward Network	Yes	Yes	Yes	Yes	Yes
Digital Toward Network	Yes	Yes	Yes	Yes	Yes
Signaling Manipulation					
Set Status of Analog Interface Leads	Yes	Yes	Yes	Yes	Yes
Set Transmit ABCD Signaling Bits	Yes	Yes	Yes	Yes	Yes
Set Receive ABCD Signaling Bits	Yes*	Yes*	Yes*	Yes*	Yes*
Monitor Status of Analog Interface Leads	Yes	Yes	Yes	Yes	Yes
Monitor Status of Transmit ABCD Signaling Bits	Yes	Yes	Yes	Yes	Yes
Monitor Status of Receive ABCD Signaling Bits	Yes	Yes	Yes	Yes	Yes
Tone Generation					
Tone Supported					
300 Hz	Yes*	Yes*	Yes*	Yes*	Yes*
1 kHz	Yes*	Yes*	Yes*	Yes*	Yes*
3 kHz	Yes*	Yes*	Yes*	Yes*	Yes*
Quiet Tone	Yes	Yes	Yes	Yes	Yes
Digital MilliWatt	Yes	Yes	Yes	Yes	Yes
Tone Direction					
Toward User	Yes	Yes	Yes	Yes	Yes
Toward Network	Yes	Yes	Yes	Yes	Yes



Note: *This feature is only supported in Cross-Connect Systems.

8.3.3 Data Diagnostics

Data diagnostics support varies among data cards. Generally, data card diagnostics supported include the setting of various levels of loopbacks toward the network or the attached DTE equipment. Other support includes the ability to generate and respond to industry-standard loop-up and loop-down codes that are compatible with DDS, V.54 and/or Fractional T1 (FT1) formats. The DS0-DP data card generates and detects DS0-DP loopback codes. The table below shows detailed information on the diagnostic capabilities of the Data cards.

	EIA530 HSU 2-port	V.35 HSU 2-port	EIA530/V.35 HSU 4-port	SRU	OCU-DP 2/5/10-port	DS0-DP 4-port
Loopbacks						
On-Card loopbacks						
Toward DTE	Yes	Yes	Yes	Yes	Yes	Yes
Toward Network	Yes	Yes	Yes	Yes	Yes	Yes
In-Band loopback Code Generation						
Latching DDS-OCU	Yes	Yes	Yes	Yes	Yes	Yes
Latching DDS-DSU	Yes	Yes	Yes	Yes	No	Yes
Latching DDS-CSU	Yes	Yes	Yes	Yes	Yes	Yes
Latching DDS-DS0	Yes	Yes	Yes	No	Yes	Yes
ITU (CCITT) V.54	Yes	Yes	Yes	No	No	No
ANSI Fractional T1 (FT1)	Yes	Yes	Yes	No	No	No
Control Lead Handling						
Set CTS	Yes	Yes	Yes	Yes	N/A	N/A
Set RLSD	Yes	Yes	Yes	Yes	N/A	N/A
Set DSR	Yes	Yes	Yes	No	N/A	N/A
Monitor RTS	Yes	Yes	Yes	Yes	N/A	N/A
Monitor DTR	Yes	Yes	Yes	No	N/A	N/A

	EIA530 HSU 2-port	V.35 HSU 2-port	EIA530/V.35 HSU 4-port	SRU	OCU-DP 2/5/10-port	DS0-DP 4-port
Bit Error Rate Tester (BERT)						
Patterns Supported						
All 1s	Yes	Yes	Yes	Yes	Yes	No
All 0s	Yes	Yes	Yes	Yes	Yes	No
1:1	Yes	Yes	Yes	Yes	Yes	No
1:7	Yes	Yes	Yes	Yes	Yes	No
511	Yes	Yes	Yes	Yes	Yes	No
2047	Yes	Yes	Yes	Yes	Yes	No
QRSS	Yes	Yes	Yes	No	Yes	No
BERT Direction						
Toward User	No	No	No	No	Yes	No
Toward Network	Yes	Yes	Yes	No	Yes	No
Statistics Gathered by BERT						
Bit Errors (BE)	Yes	Yes	Yes	Yes	Yes	No
Errored Seconds (ES)	Yes	Yes	Yes	Yes	Yes	No
Severely Errored Seconds (SES)	Yes	Yes	Yes	Yes	Yes	No
Consecutive Severely Errored Seconds	Yes	Yes	Yes	Yes	Yes	No
Out of Synchronization Seconds (OOS)	Yes	Yes	Yes	Yes	Yes	No
Bit Error Rate (BER)	Yes	Yes	Yes	Yes	Yes	No
Elapsed Seconds (ELAP)	Yes	Yes	Yes	Yes	Yes	No

8.4 System with Cross-Connect Option

8.4.1 Circuit Diagnostics

In systems equipped with Cross-Connect CPUs, the cross-connect element adds another level of testing within the node and enhances the system's diagnostic capabilities. The operator may also monitor and set the state of the Transmit and Receive ABCD signaling bits of a digitized voice circuit that is cross-connected between WANs. The table below shows detailed information on the diagnostic capabilities of the circuits.

	Voice without Signaling	Voice with Signaling	Single Data DS0 (64 Kbps)	Super-rate Data (N x 64 Kbps)
Loopbacks				
Local loopbacks				
Toward WAN1	Yes	Yes	Yes	Yes
Toward WAN2	Yes	Yes	Yes	Yes
Bit Error Rate Tester (BERT)				
Patterns Supported				
All 1s	Yes	Yes	Yes	Yes
All 0s	Yes	Yes	Yes	Yes
1:1	Yes	Yes	Yes	Yes
1:7	Yes	Yes	Yes	Yes
M_OOS	Yes	Yes	Yes	Yes
BERT Direction				
Toward WAN1	Yes	Yes	Yes	Yes
Toward WAN2	Yes	Yes	Yes	Yes
Tones Supported				
300 Hz	Yes	Yes	Yes	Yes
1 kHz	Yes	Yes	Yes	Yes
3 kHz	Yes	Yes	Yes	Yes
Tone Direction				
Toward WAN1	Yes	Yes	Yes	Yes
Toward WAN2	Yes	Yes	Yes	Yes

	Voice without Signaling	Voice with Signaling	Single Data DS0 (64 Kbps)	Super-rate Data (N x 64 Kbps)
Signaling Manipulation				
Toward WAN 1				
Set Transmit ABCD Signaling Bits	N/A	Yes	N/A	N/A
Monitor Status of Transmit ABCD Signaling Bits	N/A	Yes	N/A	N/A
Monitor Status of Receive ABCD Signaling Bits	N/A	Yes	N/A	N/A
Toward WAN 2				
Set Transmit ABCD Signaling Bits	N/A	Yes	N/A	N/A
Monitor Status of Transmit ABCD Signaling Bits	N/A	Yes	N/A	N/A
Monitor Status of Receive ABCD Signaling Bits	N/A	Yes	N/A	N/A

8.5 Benefits of Built-In Diagnostics

The real power of the integral diagnostics of the Integrated Access System can be fully appreciated when the individual diagnostic tools are applied to everyday troubleshooting such as the one illustrated in the following example.

The environment shown in Figure 8-1 consists of two integrated access devices connected by a T1 line. These are referred to as the Local IAD and the Remote IAD respectively. At the local IAD, the DTE equipment is a co-located device providing a 56 Kbps V.35 interface that is connected to a V.35 HSU port. At the Remote IAD, an OCU-DP card that interfaces to the 4-wire DDS tail-circuit extends the 56 Kbps to a third location. Consequently, the Remote IAD is equipped with an OCU-DP card that interfaces to the 4-wire DDS tail-circuit. At the third location, the DDS circuit terminates in a generic, third-party DSU/CSU which in turn provides a 56 Kbps V.35 interface to the remote DTE device.

The system operator can use the diagnostic tool kit to systematically troubleshoot the problem on an end-to-end basis and to identify the faulty sub-system, even if it is external to the Integrated Access System. One way to systematically troubleshoot the problem is illustrated in Figure 8-1. While there are many other approaches, in general, the procedure to follow is to combine loopbacks that are generated either through software commands or via industry-standard loop-up codes with Bit Error Rate Tests (BERTs) for data circuits, or test tones for voice circuits. In the Integrated Access System, all of those tools are available as integral features of the system and of the various cards. Each test determines if a specific sub-system is operating properly. In our example, after each test, the sub-systems that are shown to be functioning properly are shaded in gray.

In Figure 8-1, the local HSU card is put in Local loopback and a BERT test is run from the DTE. If successful, in Figure 8-1, diagnostics-3 the loopback sequence is advanced by putting the T1 link of the Local Integrated Access System in Local loopback and running BERT test again. This also tests the cross-connect element of the local Integrated Access System if there is one present.

In Figure 8-1, diagnostics 4, the T1 link of the remote Integrated Access System is configured in Line Loopback. Alternatively, a loop up code can be sent from the local Integrated Access System to put the T1 link of the remote Integrated Access System in Line loopback. This process is repeated until the remote DTE is put in network loopback and tested as shown in Figure 8-2, diagnostics 8.

Diagnostics 1

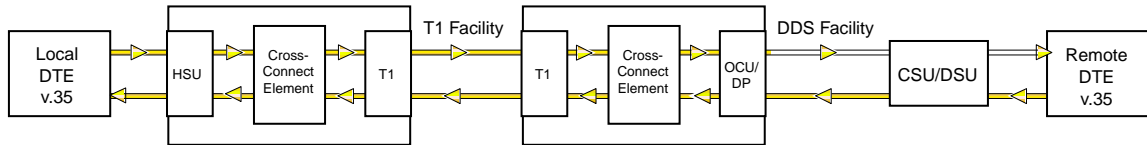

Diagnostics 2

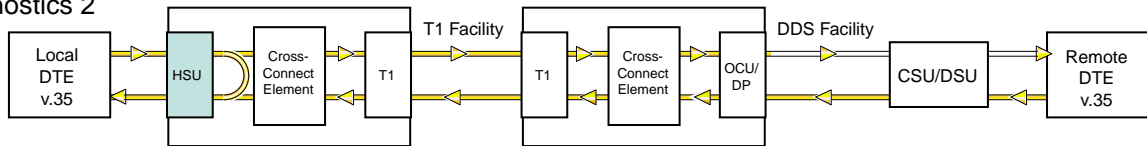

Diagnostics 3

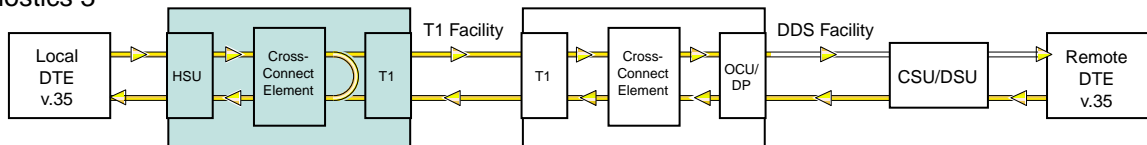

Diagnostics 4

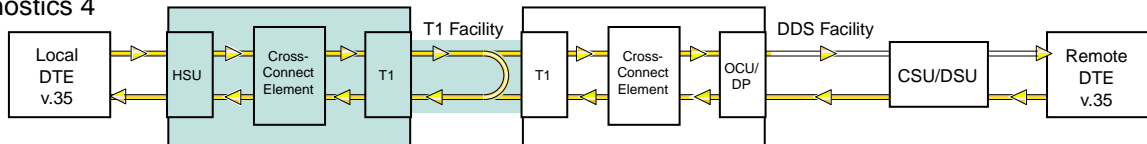

Figure 8-1. Built-In Diagnostics Example (Diagnostics 1 - 4)

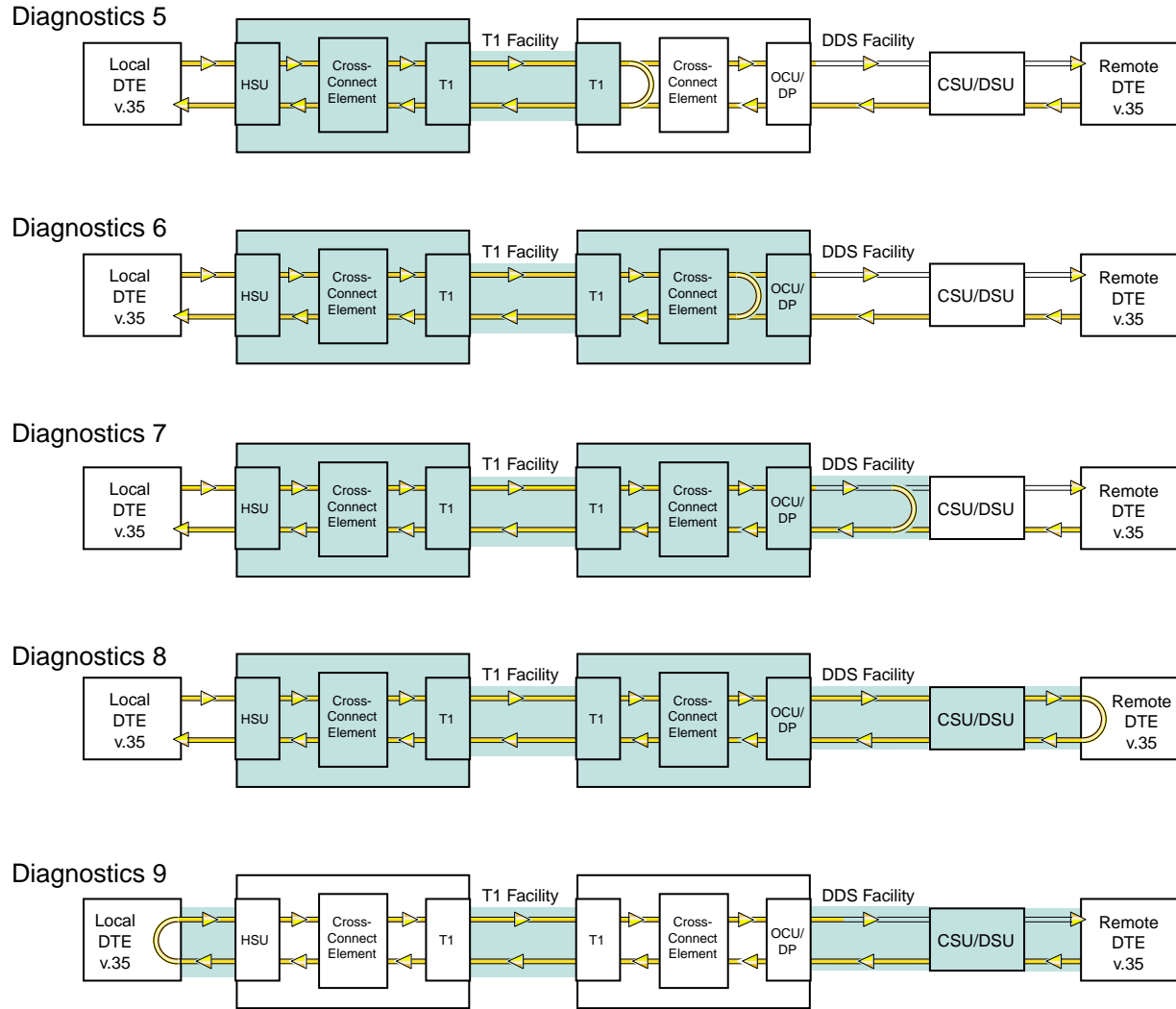

Figure 8-2. Built-In Diagnostics Example (Diagnostics 4 - 8)

8.6 Performance Monitoring

The Integrated Access System provides non-intrusive performance monitoring of T1 lines and DDS circuits that terminate on OCU-DP cards. This capability is built into the system software and does not require any special options or expensive external equipment.

8.6.1 T1 Line Performance Monitoring

Performance monitoring, statistics gathering and performance reporting of T1 facilities is supported in this system. In ESF format, CRC errors, Out-of-Frame errors, and Controlled Slips are combined to provide line quality and performance statistics in accordance with industry standards. In D4 format, Bipolar Violations (BPVs) are used instead of CRC errors. The performance statistics are gathered and displayed in fifteen-minute intervals for the preceding twenty-four hours. They include Errored Seconds, Unavailable Seconds, Severely Errored Seconds, Bursty Errored Seconds, Loss Of Frame Count, and Slipped Seconds.

In ESF mode, these statistics are available to the system operator as well as to the carrier or service provider over the embedded 4 Kbps Facilities Data Link (FDL). Each ESF T1 facility can be independently programmed to support framing according to the AT&T 54016 standard or the ANSI T1.403 standard or both simultaneously. Additionally, for each T1 in the system, the operator may select an error rate threshold (from $10E4$ to $10E-9$) which, if exceeded, will cause the system to generate an Excessive Error Rate (EER) alarm.

8.6.2 DDS Line Performance Monitoring

The two port OCU-DP card supports two methods of non-intrusive error correction. The first is Majority Vote and applies to lower data rates such as 2.4, 4.8 and 9.6 Kbps. The other is the BCH method and applies to data rates of 19.2 Kbps and 56 Kbps.

If an OCU-DP port has error correction enabled, then the system will collect and display statistics on the performance of the circuit. Performance statistics include incoming (from the T1 network) and outgoing (to the 4-wire DDS circuit) Errored Seconds, Severely Errored Seconds and Consecutive Severely Errored Seconds and are displayed in one-hour intervals for the preceding twenty-four hours.

8.6.3 Frame Relay Performance Monitoring

The Frame Relay Server accumulates performance statistics that can be used to monitor port, circuit and congestion characteristics. Statistics are gathered in 15-minute increments for a total of 24 hours. Collected statistics include the:

- Circuit transmit and receive performance
- Circuit user contract compliance information
- Circuit congestion information
- Port transmit and receive information

8.6.4 ATM Performance Monitoring

The ATM Server accumulates performance statistics used to monitor the DS3 physical link, the ATM UNI, and VBR and CBR circuit characteristics. Statistics are gathered in 15-minute increments for a total of 24 hours. Collected statistics include:

- DS3 ATM physical link performance in accordance with DS3 MIB specification
- ATM UNI performance in accordance with ATM Forum UNI 3.0 specification
- AAL 3, 4, and 5 performance in accordance with AToM MIB specification
- AAL 1 and corresponding CBR circuit performance in accordance with ATM Forum's DS1/E1 circuit emulation specification
- VBR circuit performance characteristics

Appendix A

System Standards and Specifications

A.1 Introduction

This appendix lists the Integrated Access System standards, specifications, compliance, power sources and pre-installation settings for the user cards.

A.2 Standards Compatibility

The following is a comprehensive list of standards that the System Chassis, Common Equipment and User Cards comply to, or are compatible with.

Chassis

ANSI	310-D	Racks, Panels, and Associated Equipment
Bellcore	GR-63-CORE Issue 1	Network Equipment-Building System (NEBS) Requirements: Physical Protections
	TR-NWT-000295 Issue 2	Isolated Ground Planes: Definition and Application to Telephone Central Offices
CEN	EN 500 081-1	Electromagnetic compatibility generic emission standard Part 1 Residential, commercial and light industry.
	EN 500 082-1	Electromagnetic compatibility generic immunity standard Part 1 Residential, comicality and light industry.
	EN 60 950/A2	Safety of information technology equipment including electrical business equipment
UL	1459	UL Standard for Safety of Telephone Equipment
CSAC22.2	No. 950	Safety of information technology equipment including electrical business equipment
FCC	Part 68 - Subpart B	Requirements for Connection of Terminal Equipment Systems and Protective Apparatus to the Telephone Network.
IEC	297-1	Racks, Panels and Associated Equipment
	950 A2	Safety of information technology equipment including electrical business equipment

Power Supplies

CEN	EN 60 950/A2	Safety of information technology equipment including electrical business equipment
CSA	C22.2, No. 950	Safety of information technology equipment including electrical business equipment
UL	1459, 3rd edition	UL Standard for Safety, Telephone Equipment

CPU

Bellcore	GR-63-CORE Issue 1	Network Equipment-Building System (NEBS) Requirements: Physical Protections
CEN	EN 500 081-1	Electromagnetic compatibility generic emission standard Part 1 Residential, commercial and light industry
CEN	EN 500 082-1	Electromagnetic compatibility generic immunity standard Part 1 Residential, commercial and light industry
CEN	EN 60 950/A2	Safety of information technology equipment including electrical business equipment
UL	1950	UL Standard for Safety of Information Technology Equipment
CSA	C22.2, No. 950	Safety of information technology equipment including electrical business equipment

Interface Cards

ITU-T	V.28	Electrical characteristics for unbalanced double-current interchange circuits
	G.703	Physical/Electrical Characteristics of Hierarchical Digital I/F
	V.22 bis	2400 bits per second Duplex Modem Using the Frequency Division Technique
EIA	EIA 5618 Position Non-Synchronous RS232-C	Interface between DTE and DCE Employing Serial Data Interchange
Bellcore	GR-63-CORE Issue 1	Interface between DTE and DCE Employing Serial Binary Data Network Equipment Building System (NEBS)
CEN	EN 500 081-1	Electromagnetic compatibility generic emission standard Part 1 (Residential, commercial and light industry)
	EN 60 950/A2	Safety of information technology equipment including electrical business equipment
FCC	Part 68 - Subpart B	Requirements for Connection of Terminal Equipment Systems and Protective Apparatus to the Telephone Network
UL	1459	UL Standard for Safety of Telephone Equipment
	1950	UL Standard for Safety of Information Technology Equipment
CSA	C22.2, No.950	Safety of information technology equipment including electrical business equipment

WAN Cards

AT&T	TR43801	Digital Channel Bank Requirements & Objectives
	TR54016	Requirements for Interfacing Digital Terminal Equipment to Service Employing the Extended Superframe Format
Bellcore	TR62411	Accunet T1.5 Service, Description and Interface Specifications
	TR-TSY-000008	Digital Interface Between the SLC 96 Digital Loop Carrier System and a Local Digital Switch (Issue 2 08/87)
ANSI	TR-TSY-000191	Alarm Indication Signal, Requirements and Objectives
	T1.101	Synchronization Interface Standards for Digital Networks
	T1.107	Digital Hierarchy - Formats Specifications
ITU-T	T1.403	ISDN, Network-to-Customer Installation - DS1 Metallic Interface
	T1.408	ISDN Primary Rate
	G.703	Physical/Electrical Characteristics of Hierarchical Digital I/F
	G.704	Synchronous Frame Structure Used at Primary and Secondary Hierarchical Levels
	G.732	Characteristics of Primary PCM Multiplexed Equipment Operating at 2048 Kbps.
	G.735	Characteristics of Primary PCM Multiplexed Equipment Operating at 2048 Kbps and Offering Synchronous Digital Access at 384 Kbps and/or 64 Kbps
	G.736	Characteristics of A Synchronous Digital Multiplex Equipment at 2048 Kbps
	G.823	The Control of Jitter and Wander Within Digital Networks which are based on the 2048 Kbps Hierarchy
	G.824	The Control of Jitter and Wander within Digital Networks which are based on the 1544 Kbps Hierarchy

Safety and EMC of WAN Cards

Bellcore	GR-63-CORE Issue 1	Network Equipment-Building System (NEBS) Requirements: Physical Protection
UL	1950	UL Standard for Safety of Information Technology Equipment
CSA	C22.2, No. 950	Safety of Information Technology Equipment including Electrical Business Equipment
	EN 500 081-1	Electromagnetic compatibility generic emission standard Part 1 Residential, commercial and light industry.
	EN 500 082-1	Electromagnetic compatibility generic immunity standard Part 1 Residential, commercial and light industry.
	EN 60 950/A2	Safety of information technology equipment including electrical business equipment

FXS Cards

AT&T	TR43801	Digital Channel Bank Requirements and Objectives November 1982
	TR-NWT-000057	Functional Criteria for Digital Loop Carrier System - January 1993
	GR-63-CORE	Issue 1 - Network Equipment-Building System (NEBS) Requirements: Physical Protection
ITU-T	G.712 (11/96)	Transmission Performance Characteristics of Pulse Code Modulation 9replaces G.712, G.713, G.714 and G.715)
	Q.552	Transmission Characteristics of 2-wire analog interface of a Digital Exchange
	Q.553	Transmission Characteristics of 4-wire analog interface of a Digital Exchange
FCC	Part 68 and Part 15 - Subpart B	Subpart B supersedes Subpart J
UL	1459, 3rd edition	UL Standard for Safety Telephone Equipment

FXO Cards

AT&T	TR43801	Digital Channel Bank Requirements and Objectives November 1982
	TR-NWT-000057	Functional Criteria for Digital Loop Carrier System January 1993
	GR-63-CORE Issue 1	Network Equipment-Building System (NEBS) Requirements: Physical Protection
ITU-T	G.712 (11/96)	Transmission Performance Characteristics of Pulse Code Modulation (replaces G.712, G.713, G.714 and G.715)
	Q.552	Transmission Characteristics of 2-wire analog interface of a Digital Exchange
	Q.553	Transmission Characteristics of 4-wire analog interface of a Digital Exchange
FCC	Part 68, and Part 15 - Subpart B	Subpart B supersedes Subpart J
UL	1459, 3rd edition	UL Standard for Safety, Telephone Equipment

E&M Cards

Bell System	TR433801	Digital Channel Bank Requirements and Objectives - November 1982
	TR-NWT-000057	Functional Criteria for Digital Loop Carrier System - January 1993
	GR-63-CORE Issue 1	Network Equipment-Building System (NEBS) Requirements: Physical Protection
ITU-T	G.712 (11/96)	Transmission Performance Characteristics of Pulse Code Modulation (replaces G.712, G.713, G.714 and G.715)
	Q.552	Transmission Characteristics of 2-wire analog interface of a Digital Exchange
	Q.553	Transmission Characteristics of 4-wire analog interface of a Digital Exchange
FCC	Rules and Regulations	Part 68 and Part 15 - Subpart B (Subpart B supersedes Subpart J)
UL	1459, 3rd edition	UL Standard for Safety Telephone Equipment
UL	1950	UL Standard for Safety of Information Technology Equipment
CEN	EN 500 081-1	Electromagnetic compatibility generic emission standard Part 1 Residential, commercial and light industry
	EN 500 082-1	Electromagnetic compatibility generic immunity standard Part 1 Residential, commercial and light industry
	EN 60 950/A2	Safety of information technology equipment including electrical business equipment

FRAD Cards

BellCore	GR-63-CORE Issue 1	Network Equipment-Building System (NEBS) Requirements: Physical Protection
AT&T	TR54075	Subrate Data Multiplexing - A Service of DATAPHONE Digital Service
ITU-T	V.28	Electrical characteristics of unbalanced double-current interchange circuits
UL	1950	UL Standard for Safety of Information Technology Equipment
CEN	EN 500 081-1	Electromagnetic compatibility generic emission standard Part 1 Residential, commercial and light industry
	EN 500 082-1	Electromagnetic compatibility generic immunity standard Part 1 Residential, commercial and light industry
	EN 60 950/A2	Safety of information technology equipment including electrical business equipment

OCU-DP Card

AT&T	TR 62411	Accunet T1.5 Service, Description and Interface Specifications
Bellcore	TA-TSY-000077	Digital Channel Banks-Requirements for Data port Channel Unit Functions, Issue 2, April 1986
	TA-TSY-000083	Generic Requirements for the Digital Data System (DDS) Network Office Channel Unit, Issue 2, April 1986
BellCore	Pub 62310	DS0 Digital Local Channel Description and Interface Specification, August 1993
ANSI	T1.107-1988	Digital Hierarchy - Format Specifications 1988

BRI Cards (Models 826070 and 826171)

ANSI	T1.601	ISDN Basic Access Interface for Use on Metallic Loops for Application on the Network Side of the NT (layer 1 Specification)
	T1.602	ISDN Data1 Link Layer Signaling Specification for Application at the User-Network Interface
ITU-T	1.430	ISDN, Basic User-Network Interface - Layer 1 specification
	TR-NWT-000397	ISDN Basic Access Transport System Requirements
	GR-000303	Integrated Digital Loop Carrier System Generic Requirements, Objectives and Interface

BRI Card (Models 826270, 826361 and 826461)

ANSI	T1.605	ISDN Basic Access Interface for S and T Reference Layer 1 Specification
ITU-T	1.430	ISDN Basic User-Network Interface - Layer 1 Specification
BellCore	TR-NWT-000397	ISDN Basic Access Transport System Requirements
	GR-000303	Integrated Digital Loop Carrier System Generic Requirements, Objectives and Interface

B7R Card

4.1 EIA	RS232-C	Interface Between DTE and DCE Employing Serial Binary Data Interchange
4.2 ITU-T	V.28	Electrical characteristics for unbalanced double-current interchange circuits

HSU Cards

BellCore	GR-63-CORE Issue 1	Network Equipment-Building System (NEBS) Requirements: Physical Protection
ITU-T	V.35	Data Transmission of 48 kbps using 60-108 kHz Group Bank Circuits
	V.11 (10/96)	Electrical characteristics for balanced double-current interchange circuits operating at data signaling rates up to 10 Mbps
	V.28	Electrical characteristics for unbalanced double-current interchange circuits
	G.704	Synchronous frame structures used at 1544, 6312, 2048, 8488 and 44 736 Kbps hierarchical levels
	V.25bis	(Model 8213 only) Automatic answering equipment and general procedures for automatic calling equipment on the general switched telephone network including procedures for disabling of echo control devices for both manually and automatically
EIA	RS-422	Electrical Characteristics of Balanced Voltage Digital Interface Circuits
	RS-449	General Purpose 37 Position and 9 Position Interface for DTE and DCE Equipment Employing Serial Binary Data Interchanges
	RS-530	High Speed 25 Position Interface for Data Terminal Equipment, Including Alternative 25 Position Connector
	RS-366	Interface Between Data Terminal Equipment and Automatic Calling Equipment for Data Communication
UL	1950	UL Standard for Safety of Information Technology Equipment
CEN	EN 500 081-1	Electromagnetic compatibility generic emission standard Part 1 Residential, commercial and light industry
	EN 500 082-1	Electromagnetic compatibility generic immunity standard Part 1 Residential, commercial and light industry
	EN 60 950/A2	Safety of information technology equipment including electrical business equipment

SRU Card

BellCore	GR-63-CORE Issue 1	Network Equipment-Building System (NEBS) Requirements: Physical Protection
AT&T	TR54075	Subrate Data Multiplexing - A Service of DATAPHONE Digital Service
ITU-T	V.24	Definitions of Interchange Circuits Between DTE and DCE
	V.28	Electrical characteristics of unbalanced double-current interchange circuits
	X.50	Division 3 Fundamental Parameters of a Multiplexing Scheme for the International Interface Between Synchronous Data Networks (note: does not support 600bps data)
	V.14	Transmission of Start-Stop Characters over Synchronous Bearer Channels (using Async to synch converters)
EIA	RS232-C	Interface Between DTE and DCE Employing Serial Binary Data Interchange
UL	1950	UL Standard for Safety of Information Technology Equipment
CEN	EN 500 081-1	Electromagnetic compatibility generic emission standard Part 1 Residential, commercial and light industry
	EN 500 082-1	Electromagnetic compatibility generic immunity standard Part 1 Residential, commercial and light industry
	EN 60 950/A2	Safety of information technology equipment including electrical business equipment

A.3 Chassis Standards

A.3.1 Dimensions

Chassis Description	Model Number	Height		Width		Depth		Weight	
		in	cm	in	cm	in	cm	lb.	kg
600 Chassis with Installation Kit Steel Chassis, Front Loading, "V" Steel Card Guides, CE Marked	891630	9.12	23.16	17.042	43.29	9.121	23.19	7.44	3.38
800 Chassis with Installation Kit, Steel Chassis, Front and Rear Loading, "V" Steel Card Guides, CE Marked	891830	9.12	23.16	16.99	43.15	15.30	38.86	13.88	6.31
900 Chassis with Installation Kit, Power-Enhanced, Steel Chassis, Top and Bottom Front Loading, "V" Steel Card Guides, CE Marked	891930	15.38	39.05	16.92	42.97	9.11	23.13	15.28	6.95



Note: 1. Weight is weight of empty chassis with backplanes and power distribution channel.
2. Installation kits consist of:

- Power supply cover
- Blank filler panels
- Rack mounting brackets and hardware
- AC power cord

A.3.2 Chassis Power

Chassis Description	Model Number	AC Power (50-60 Hz)		DC Power		Power Consumption
		110 VAC	220 VAC	-48 VDC	24 VDC	Watts
600 Chassis with Installation Kit Steel Chassis, Front Loading, "V" Steel Card Guides, CE Marked	891630	90 VAC to 135 VAC	175 VAC to 264 VAC	-40 VDC to -60 VDC	+18 VDC to 35 VDC	125 (typical) 300 W (maximum)
800 Chassis with Installation Kit, Steel Chassis, Front and Rear Loading, "V" Steel Card Guides, CE Marked	891830	90 VAC to 135 VAC	175 VAC to 264 VAC	-40 VDC to -60 VDC	+18 VDC to 35 VDC	125 (typical) 300 W (maximum)
900 Chassis with Installation Kit, Power-Enhanced, Steel Chassis, Top and Bottom Front Loading, "V" Steel Card Guides, CE Marked	891930	115 VAC 104 to 135 VAC	175 VAC to 264 VAC	-40 VDC to -60 VDC	+18 VDC to 35 VDC	125 (typical) 500 W (maximum)

A.3.3 Environment

A.3.3.1 Ambient Temperature and Humidity

Ambient temperature and humidity as per GR-63-CORE R4-6 and R4-7.

Temperature ° C / ° F			Humidity	
Operate	Short Term	Storage	Operate	Short Term
0 to 50 ° C 32 to 122 ° F	-5 to 50 ° C 23 to 122 ° F	-20 to 80 ° C -4 to 176 ° F	50 to 95% relative humidity, non condensing	5 - 90 (not to exceed 0.024 kb H ₂ O/kg dry air)
Rate of temperature change		30 ° C/hr (54 ° F/hr)		

Ambient refers to conditions at a location 1.5 m (59 in) above the floor and 400 mm (15.8 in) in front of the equipment. Short-term refers to a period of not more than 96 consecutive hours and a total of not more than 15 days in 1 year. This refers to a total of 360 hours in any given year, but, no more than 15 occurrences during that 1 year period.

A.3.3.2 Altitude

As per GR-63-CORE R4-8. Functional within the limits specified in the table above when installed at elevations between 60 m (197 ft.) below sea level and 1800 m (5905 ft.) above sea level. As per O4-10. Functional within the limits specified in the table above when installed at elevations between 1800 m (5905 ft.) and 4000 m (13,123 ft.) above sea level.

A.3.3.3 Airflow

Convection cooled (no fans required). Except for Model 891930 Power Enhanced Chassis.

A.3.3.4 Fire Resistance

As per GR-63-CORE Section 4.2.2.2 Shelf-Level Fire-Resistance Criteria R4-19 for **Firespread** R4-20, **Fire Propagation** R4-21, O4-22 and O4-23.

A.3.4 Equipment Handling

A.3.4.1 Packaged Equipment Shock Criteria

As per GR-63-CORE Section 4.3.1.1 for category A containers, R4-41.

A.3.4.2 Unpackaged Equipment Shock Criteria

As per GR-63-CORE Section 4.3.2 R4-43.

A.3.5 Earthquake, Office Vibration and Transportation Vibration

A.3.5.1 Earthquake

To Zone 4 Profile (Zone 4 is most severe so equipment also meets Zones 0, 1, 2, and 3 criteria). Physical performance as per GR-63-CORE Section 4.4.1.2 R4-44. Functional performance as per GR-63-CORE Section 4.4.1.2 R4-48 and R4-49.

A.3.5.2 Office Vibration

Physical performance as per GR-63-CORE Section 4.4.3.2 R4-56. Functional performance as per GR-63-CORE Section 4.4.3.3 R4-57.

A.3.5.3 Transportation Vibration

Physical performance as per GR-63-CORE Section 4.4.4.1 R4-58.

A.3.6 Cable/Power Connections

- Chassis Model 891630 - front panel
- Chassis Model 891830 - rear panel
- Chassis Model 891930 - front panel

A.3.7 Mounting

A.3.7.1 Types

EIA 19" (482 mm) Standard Open Rack or Enclosed Cabinet. WECCO 23" Standard Open Rack or Enclosed Cabinet. Wall and Table Mount.

A.3.7.2 Clearance

Chassis	Series 891630	Series 891830	Series 891930
Front	15" (38 cm)	15" (38cm)	15" (38cm)
Back	0" (0 cm)	10" (25 cm)	0" (0 cm)
Top	2" (5 cm)	2" (5 cm)	2" (5 cm)
Bottom	2" (5 cm)	2" (5 cm)	2: (5 cm)



Note: *These clearance requirements also account for the distance requirement for removing cards from the chassis.*

A.3.8 Number of Slots

Chassis	891630	891830	891930
Front Logic Backplane			
	9	9	18
CPU	2	2	2
Server	note 1	3	3
WAN	note 1	4	4
Interface	1	N/A	1
User	note 1	N/A	8
Sever/User	4 - note 1	N/A	N/A
WAN/User	4 - note 1	N/A	N/A
Front Power Backplane	3 - note 2	w	7
Rear Logic Backplane			
	N/A	9	N/A
Interface	N/A	1	N/A
User	N/A	8	N/A
Rear Power Backplane			
	N/A	5	N/A



Note: Note 1 - 8 slots on the 8916 are multi-purpose. Four (4) will accept either Server or User cards and 4 will accept either WAN or user cards.



Note: Note 2 - These slots can accommodate either two (redundant) power supplies or a single power supply with a voltage converter and ringing generator or a single power supply with two ringing generators.

A.4 System Power Supplies and Converters

The following is a list of standards for the Integrated Access System power supplies, converters and ring generators.

Model 8901 AC Power Supply 120/240 VAC, CE Marked

Input Voltage	Self detecting 90VAC to 135VAC at 60 Hz 175VAC to 264VAC at 50 Hz
Input Frequency	47 to 63 Hz
Inrush Surge Current	maximum 12 amp peak at 264 VAC cold start
Output Power	55 W Continuous
Max. No. per System	2
Redundancy	Optional
Ventilation	Convection Cooled
Protection	Unit is fused and protect from short circuits and over-voltage
Approvals	EN 60950/A2, EN 50 081-1, EN 50 082-1, UL 1459, UL 1950, CSA-C22.2 No. 950

Model 8902 DC Power Supply -48 VDC, CE Marked

Input Voltage	-42 to -60 VDC
Inrush Surge Current	maximum 12 amp at 60VDC
Output Power	55 W Continuous
Max. No. per System	2
Redundancy	Optional
Ventilation	Convection cooled
Protection	Unit is fused protected from short circuits and over-voltage Unit is diode protected from reversed polarity
Approvals	EN 60950/A2, EN 50 081-1, EN 50 082-1, UL 1459, UL 1950, CSA-C22.2 No. 950

Model 8903 Power Converter 120 VAC to -48 VDC

Input Voltage	90 VAC to 132 VAC
Input Frequency	60 Hz
Inrush Surge Current	maximum 20 amp peak at 132 VAC cold start
Output Power	100 W Continuous
Output Voltage	-48.0 VDC
Output Current	2 amp
Max. No. per System	2
Redundancy	Optional
Ventilation	Convection cooled
Approvals	UL 1459, UL 1950, CSA-C22.2 No. 950

Model 8904 Internal Ringing Generator (Discontinued)

Input Voltage	44 to 56 VDC
Output Power	10 W
Output Voltage	105 VDC rms default - adjustable from 60 to 105 Vrms
Output Current	100 mA rms
Output Frequency	20 Hz
Max. No. per System	5, 1 Master, up to 4 Slave
Redundancy	There is no provision for Master Ringer redundancy, however the slave units back each other up.
Ventilation	Convection cooled
Approvals	En 60950/A2, EN 50 081-1, EN 50 082-1, UL 1459, UL 1950, CSA-C22.2 No. 950

Model 8905 Power Converter 120/240 VAC to -48 VDC, 100 W, CE Marked

Input Voltage	90 Vrms to 260 Vrms
Input Frequency	50/60 Hz
Output Power	100 W Max.
Output Voltage	-48.0 VDC
Output Current	2 amp
Max. No. per System	2
Redundancy	Optional
Ventilation	Convection cooled
Approvals	EN 60950/A2, EN 50 081-1, EN 50 082-1, UL 1459, UL 1950, CSA-C22.2 No. 950

Model 8906 Ring Generator, -48 VDC

Input Voltage	45 to 56 VDC
Efficiency	60% at 48 V and 1 kOhm load
Protection	5 A slow blow fuse, primary current limiting
Noise	Less than 32 dBrnc
Output Voltage	100 VDC rms default - adjustable from 60 to 105 Vrms
Output Current	160 mA RMS Continuous
Output Frequency	20 Hz \pm 1 Hz
Protection	Output short circuit and overload protection
Operational Modes	Strap selectable: Master or Slave
Max. No. per System	
600 System	1
800 and 900 System	5:1 Master, up to 4 Slave
Redundancy	There is no provision for Master Ringer redundancy, however the slave units back each other up.
Ventilation	Convection cooled
Approvals	UL 1459, UL 1950, CSA-C22.2 No. 950

Model 8907 Power Supply -24 VDC, CE Marked

Input Voltage	18 to 36 VDC
Input Surge Current	Maximum 12 amp at 36 VDC
Output Power	Continuous 55 W
Max. No. per System	2
Redundancy	Optional
Ventilation	Convection cooled
Protection	Unit is fused protected from short circuits and over-voltage Unit is diode protected from reversed polarity
Approvals	EN 60950/A2, EN 50 081-1, EN 50 082-1, UL 1459, UL 1950, CSA-C22.2 No. 950

Model 8908 Power Converter 120/240 VAC to -48 VDC, CE Marked

Input Voltage	100 Vrms to 260 Vrms
Input Frequency	50/60 Hz
Output Power	300 W Continuous
Output Voltage	-48 VDC
Output Current	7 amp
Max. No. per System	2
Redundancy	Optional
Ventilation	Fan cooled
Approvals	EN 60950/A2, EN 50 081-1, EN 50 082-1, UL 1459, UL 1950, CSA-C22.2 No. 950

A.4.1 Power Supply Compatibility

Power Sources	AC Power Supply	-48V Power Supply	-48V Converters	Ringling Gen.	+24V Power Supply	External -48 VDC Power	External Ringing Generator
AC Power Supply	---	yes	yes	yes	yes	yes	yes
-48V Power Supply	yes	---	no	yes	no	yes	yes
-48V Converters	yes	no	---	yes	no	no	yes
Ringling Gen.	yes	yes	yes	---	no	yes	no
+24V Power Supply	yes	no	no	no	---	no	yes
External -48 VDC Power	yes	yes	no	yes	no	---	yes
External Ringing Generator	yes	yes	yes	no	yes	yes	---

A.4.2 External Talk Battery Fuses

Manufacturer	Part Number
Little Fuse	218.005
Bussman	GDC-5

A.5 Card Specifications

A.5.1 Dimensions and Power Consumption

Item	Model	Height		Width		Depth		Weight		Power	
		inches	cm	inches	cm	inches	cm	lb	Kg	Watt	BTU/hr
CPU Card 5.X	880360	8.0	20.3	.94	2.4	7.5	19.0	.75	.32	3.63	12.37
Interface Card	892260	8.0	20.3	.94	2.4	7.5	19.0	1.0	.45	.85	2.90
Interface Card	892360	8.0	20.3	.94	2.4	7.5	19.0	1.0	.45	.85	2.90
Interface Card	892460	8.0	20.3	.94	2.4	7.5	19.0	1.0	.45	.85	2.90
Network Cards											
WAN Card	800060	8.0	20.3	.94	2.4	7.5	19.0	.75	.32	1.1	3.75
WAN Card	801060	8.0	20.3	.94	2.4	7.5	19.0	.75	.32	1.5	5.12
WAN Card (HDSL)	801160	8.0	20.3	.94	2.4	7.5	19.0	.75	.32	3.1	10.49
WAN Card	801460	8.0	20.3	.94	2.4	7.5	19.0	.75	.32	2	6.83
WAN Card ESF Loopback	801560	8.0	20.3	.94	2.4	7.5	19.0	.75	.32	2	6.83
WAN Card HDSL PairGain	802060	8.0	20.3	.94	2.4	7.5	19.0	.75	.32	2	6.83
Modules											
DSX/CEPT Module	81130	3.63	9.22	2.06	5.2	.50	1.27	.062	.028	0.45	1.54
CSU Module	81230	3.69	9.37	2.13	5.4	.38	.95	.062	.028	0.25	0.85
HDSL Plug-in	82030	3.69	9.37	3.65	9.2	.50	1.27	.75	.32	3.1	10.49
HDSL Pair Gain	82100	3.69	9.37	3.65	9.2	.50	1.27	.75	.32	3.1	10.49
Voice Cards											
E&M Card	810860	8.0	20.3	.94	2.4	7.5	19.0	1.0	.45	3.4	11.61
E&M Card*	8115	8.0	20.3	.94	2.4	7.5	19.0	1.0	.45	1.75	5.97
E&M 4W*8-2713Hz Card	811760	8.0	20.3	.94	2.4	7.5	19.0	1.0	.45	--	--
E&M Card	8118	8.0	20.3	.94	2.4	7.5	19.0	1.0	.45	3.4	11.61
E&M Card	811960	8.0	20.3	.94	2.4	7.5	19.0	1.0	.45	3.5	11.94
FXS Card*	8124	8.0	20.3	.94	2.4	7.5	19.0	1.0	.45	4.85	16.54
FXS Card	8125	8.0	20.3	.94	2.4	7.5	19.0	1.0	.45	4.85	16.54
FXS Card*	8128	8.0	20.3	.94	2.4	7.5	19.0	1.0	.45	9.7	33.12
FXS Card	812960	8.0	20.3	.94	2.4	7.5	19.0	1.0	.45	9.7	33.12
FXS Coin Card	814960	8.0	20.3	.94	2.4	7.5	19.0	1.0	.45	9.7	33.12
FXO Card*	8134	8.0	20.3	.94	2.4	7.5	19.0	1.25	.57	3.5	11.94
FXO Card*	8135	8.0	20.3	.94	2.4	7.5	19.0	1.25	.57	3.5	11.94
FXO Card*	8138	8.0	20.3	.94	2.4	7.5	19.0	1.25	.57	7	23.9
FXO Card	813960	8.0	20.3	.94	2.4	7.5	19.0	1.25	.57	7	23.9
FXO Coin Card	815960	8.0	20.3	.94	2.4	7.5	19.0	1.0	.45	9.7	33.12
LBRV-8 FAX Card	830060	--	--	--	--	--	--	--	--	--	--
LBRV-16 FAX Card	831060	--	--	--	--	--	--	--	--	--	--
PPS Card	812160	8.0	20.3	.94	2.4	7.5	19.0	1.0	.45	3.5	11.94
PPO Card	813161	8.0	20.3	.94	2.4	7.5	19.0	1.0	.45	3.5	11.94

Item	Model	Height		Width		Depth		Weight		Power	
		inches	cm	inches	cm	inches	cm	lb	Kg	Watt	BTU/hr
Data Cards											
HSU Card	820260	8.0	20.3	.94	2.4	7.5	19.0	.5	.23	3.4	11.61
HSU Card	820360	8.0	20.3	.94	2.4	7.5	19.0	.5	.23	2.6	8.94
HSU Card	821260	8.0	20.3	.94	2.4	7.5	19.0	.5	.23	2.5	8.54
HSU Card	821360	8.0	20.3	.94	2.4	7.5	19.0	.5	.23	3.0	10.23
HSU Card	821460	8.0	20.3	.94	2.4	7.5	19.0	.5	.23	2.5	8.54
HSU Card	821560	8.0	20.3	.94	2.4	7.5	19.0	.5	.23	3.5	11.94
HSU*4E 530/35	821660	8.0	20.3	.94	2.4	7.5	19.0	.5	.23	3.5	11.94
SRU Card	822060	8.0	20.3	.94	2.4	7.5	19.0	.5	.23	4.6	15.7
SRU C&D Bus Card	822160	8.0	20.3	.94	2.4	7.5	19.0	.5	.23	--	--
B7R Card	822860	8.0	20.3	.94	2.4	7.5	19.0	.5	.23	4.6	15.7
FRAD Card	823160	8.0	20.3	.94	2.4	7.5	19.0	.5	.23	2.5	8.54
OCU-DP - 5 Port	824160	8.0	20.3	.94	2.4	7.5	19.0	1.0	.45	10.00	30.65
OCU-DP 10-Port	824660	8.0	20.3	.94	2.4	7.5	19.0	1.0	.45	19.8	62.17
OCU-DP 2-Port	8249	8.0	20.3	.94	2.4	7.5	19.0	.5	.23	2.4	8.2
DS0-DP Card	825460	8.0	20.3	.94	2.4	7.5	19.0	.5	.23	3.1	10.58
BRI-U Card	826070	8.0	20.3	.94	2.4	7.5	19.0	1.0	.45	6.3	21.48
BRI-U Card	826171	8.0	20.3	.94	2.4	7.5	19.0	1.0	.45	6.3	21.48
BRI-ST Card	826270	8.0	20.3	.94	2.4	7.5	19.0	1.0	.45	6.3	21.48
Alarm Cards											
Alarm Card	840160	8.0	20.3	.94	2.4	7.5	19.0	.5	.23	0.4	1.37
Alarm Card	840260	8.0	20.3	.94	2.4	7.5	19.0	.5	.23	.58	1.98
Alarm Card	840360	8.0	20.3	.94	2.4	7.5	19.0	.5	.23	5.76	19.64
Server Cards											
DSP Card	830060	8.0	20.3	.94	2.4	7.5	19.0	.7	.32	8.8	30.00
ACS-FRS Card	881160	8.0	20.3	.94	2.4	7.5	19.0	1.0	.45	5.0	17.06
ACS-FRS International Card	881163	8.0	20.3	.94	2.4	7.5	19.0	1.0	.45	5.0	17.06
ACS-MCC Card	881360	8.0	20.3	.94	2.4	7.5	19.0	1.0	.45	5.0	17.06
ACS-ATM Card	882060	8.0	20.3	.94	2.4	7.5	19.0	1.0	.45	7.75	26.44
IPR 10B2 Card	883060	--	--	--	--	--	--	--	--	--	--
IPR 10BT Card	883160	--	--	--	--	--	--	--	--	--	--
ISDN-PRI Card	884060	8.0	20.3	.94	2.4	7.5	19.0	1.0	.45	5.0	17.06
ADPCM Card	887160	8.0	20.3	.94	2.4	7.5	19.0	.5	.23	6.1	20.80
IMUX Card	8880	8.0	20.3	.94	2.4	7.5	19.0	1.0	.45	3.46	11.81



Note: *These products have been Manufacturing Discontinued (MD), but are supported under this product host code for backward compatibility.

A.5.2 Card Current Measurements

Card Name and Description	+5VDC Stndby Active		-5VDC Stndby Active		+12VDC Stndby Active		-12VDC Stndby Active	
DCC	N/A	84	N/A	0	N/A	0	N/A	0
WAN Relay Module	0	16	0	0	0	131	0	0
OCU-DP Port Activator Card	578	768	0	0	4	118	0	0
WAN, Single, CSU	218	246	0	0	0	24	0	0
WAN, Single, DSX, T1	219	235	0	0	0	24	0	0
WAN, Single, CEPT E1-75 Ohms	209	226	0	0	0	24	0	0
WAN, Single, CEPT E1-120 Ohms	207	224	0	0	0	24	0	0
WAN, Dual, CSU	287	340	0	0	0	48	0	0
WAN, Dual, DSX T1	252	286	0	0	0	48	0	0
WAN, Dual, CEPT E1-75 Ohms	360	393	0	0	0	48	0	0
WAN, Dual, CEPT E1-120 Ohms	358	391	0	0	0	48	0	0
WAN, HDSL	960	940	78	78	0	50	0	0
WAN, HDSL PairGain	N/A	N/A	N/A	N/A	N/A	N/A	N/A	N/A
WAN w/Redundancy Relays	223	274	0	0	0	178	0	0
E&M, 8 Channels	73	84	72	70	17	104	16	16
E&M, 8 Channels, Extended TLP	73	84	72	70	17	104	16	16
FXS, 4 Channels, 600 Ohms	37	45	35	34	20	65	15	15
FXS, 8 Channels, 600 Ohms	77	96	76	73	23	112	17	17
FXO, 8 Channels, 600 Ohms	89	99	77	75	16	105	15	15
FXS Coin, 6 Channels, 600 Ohms	59	80	57	57	69	140	15	15
FXO Coin, 8 Channels, 600 Ohms	96	107	62	62	16	110	16	19
LBRV	N/A	N/A	N/A	N/A	N/A	N/A	N/A	N/A
HSU, RS-530, 2 Ports	348	376	7	6	0	0	0	0
HSU, RS-530 or X.21, 2 Ports	230	344	16	20	7	13	0	0
HSU, V.35, 2 Ports	248	362	107	239	0	0	0	0
HSU, RS-530/366, 2 Ports	350	428	13	12	0	0	0	0
HSU, V.25bis, 4 Ports	565	621	10	11	0	0	0	0
SRU, 10 Ports	157	168	0	0	89	138	145	106
SRU C&D Bus, 10 Ports	157	168	0	0	89	138	145	106
B7R, Bit-7 Redundant	121	135	0	0	9	9	20	21
FRAD	136	136	0	0	3	23	3	23
OCU-DP, 10 Ports	645	928	0	0	7	8	0	0
OCU-DP, 5 Ports	364	450	0	0	4	69	0	0
OCU-DP, 2 Ports	182	203	0	0	6	44	0	0
DS0-DP, 4 Ports	183	259	0	0	2	2	0	0
BRI, U-Interface	168	643	0	0	4	4	0	0
BRI, U-Interface	145	667	0	0	6	6	0	0
BRI, S-Interface	97	152	0	0	6	6	0	0
Alarm	0	5	0	0	0	45	0	0
External Alarm, Enhanced	0	4	0	0	12	47	0	0
28-Port Alarm Card	30	36	0	0	12	300	18	165
CPU, Universal	N/A	240	0	0	N/A	8	N/A	8
ADPCM Resource	550	585	0	0	0	0	0	0
FRS Server	N/A	760	0	0	0	0	0	0
MCC Server	N/A	1550	0	0	0	0	0	0
ATM Server	N/A	346	0	0	N/A	7	N/A	7
PRI-BRI Server	N/A	N/A	N/A	N/A	N/A	N/A	N/A	N/A
IPR 10Base2 Server	770	N/A	N/A	N/A	5	N/A	N/A	N/A
IPR 10BaseT Server	770	N/A	N/A	N/A	5	N/A	N/A	N/A
IMUX Server	685	685	0	0	0	0	0	0
ISDN-PRI Server	113	139	0	0	0	0	0	0
Interface with Modem	N/A	136	N/A	0	N/A	11	N/A	0
Interface	N/A	80	N/A	0	N/A	25	N/A	8

A.5.3 Pre-Installation Card Setup

The table shown below lists all system user cards that require pre-installation setup. Refer to the separate card chapters in this manual for more information about system settings and configuration parameters.

Card	Model	Jumpers or Switches	Options
WAN: DSX/CEPT Module	81130	JP1-4	T1/E1, 75 Ohm / 120 Ohm
Interface Card	892760	JP2-4	Balanced / Unbalanced Operation
Alarm Card	840160	JP1-4	Active / Passive
Alarm Card	840360	JP1-4	Active / Passive
E&M Card	810860	SW1-4	S1-Source of the E (receive or Earth) lead; can be internal (INT) or external (EXT) S2-Internal source E lead; either battery (-48VDC) or ground (GND). S3-Internal source for transmit or magnetic lead; either battery (-48VDC) or ground (GND). S4-Switch (ON) for ground or open (OFF). All eight ports must be set to the same position (all ON or all OFF).
E&M Card	8115	SW1-4	GND / BAT Options
E&M Card	8118	SW-14	GND / BAT Options
E&M Card	811960	SW1-4	GND / BAT Options
FXS Card	8124	SW1-4	GND /BAT Options
FXS Card	812960	JP1, JP2	JP1 (US/EUR) and JP2 for SL (Short Loop) and LL (Long Loop) between 700 Ohms and 1800 Ohms. Default is LL
FXO Card	8134	P1-8: JP1,2	MRD Option
FXO Card	8135	P1-8: JP1,2	MRD Option
FXS Coin Card	814960	JP2, JP3, JP4, JP101, JP201, JP301, JP401, JP501 and JP601	JP2 Global Signal Frequency Selection (0.5/1/2 Brms). JP3 Global Loop Length Selection SL (Short Loop) 700 Ohms, or LL (Long Loop) 700 Ohms and 1800 Ohms. JP4 US/EURO. JP101 through JP601 per channel metering signal frequency selection.
FXO Coin Card	815960	Jumpers #1 and #2	To convert individual ports for MRD (Manual Ringdown) mode. Connect shorting jumpers vertically from #1 to #2 on both sets of pins next to front of card.
HSU Card	820260	P1, 2 Switch	RS-530/V.35 IF Option
HSU Card	821360	RS-530, V.35	Card switches for operation of ports 1 and 2 in either the RS-530 or V.35 mode.
HSU Card	821460	JP3	US or European setting.
HSU Card	821560	P1-4 Switch	RS530/V.35 IF Option
HSU Card	821660	RS-530, V.35	Card switches for operation of ports 1 and 2 in either the RS-530 or V.35 mode.
SRU Card	822060	JP1, JP2	US and European jumper settings.
SRU C&D Bus Card	822160	JP1, JP2	Us and European jumper settings.
FRAD Card	823160	JP1, JP2, JP9	US and European jumper settings.
BRI-U Card	826070	JP1, JP2, JP9, JP101-JP602	US and European jumper pair.
BRI-U Card	826171	JP101-JP801 JP102-JP802	LT/NT Option 7.5/15 ma sealing current
BRI-ST Card	826270	JP1, JP2, JP5, JP6, JP101-JP804	JPx02 provides 100 Ohm transmit termination. JPx03 are installed as the default to apply a 100 Ohm receive termination. JPx01 and JPx04 are installed (ON) to provide either internal (INT) or external (EXT) -48V power to phantom leads based on settings from JP5 and JP6.

A.6 Part Number / Acronym Table

The following table details the Product Part Number of each card or peripheral listed in this guide.

Name/Acronym	Product #	Name/Acronym	Product #
WAN Cards		Data Cards	
WAN SINGLE	800060	HSU-T 530	820360
WAN DUAL	801060	HSU 35	821260
WAN-U DUAL	801160	HSU-AD 530/35	821360
WAN-R DUAL	801460	HSU-T 35	821460
WAN-LB DUAL	801560	HSU*4 530/35	821570
WAN HDSL	802060	HSU*4E 530/35	821660
Voice Cards		SRU 232*10	822060
E&M 2W*8	810860	SRU 232*10	822160
E&M-LB 4W*8	811760	SRU 422*4	822460
E&M 4W*8	811960	SRU-LD*10	822560
FXS 2W*8-6	812960	FRAD 232*10	823160
FXO 2W*8-6	813960	OCU-DP 10	824660
FXS-C 2W*6-6	814960	OCU-DP 5	824160
FXO-C 2W*8-6	815960	OCU-DP 2	8249
DSP-8	830060	DS0-DP 4	825460
DSP LBRV16	831060	BRI U*8	826070
PPO 2W*8-9	813160	BRI-SC U*8	826171
PPS 2W*8-9	812160	BRI-S*8	826270
Server Cards		BNR 232*8	822860
ACS-FRS	881160	PM-IOR	828060
ACS-IPR	881161	CPU & Interface Cards	
ACS-PRI	881162	CPU-5 XCON	880320
ACS-MCC	881360	INF-E T1E1*8	892260
ACS-ATM	882060	INF-E T1E1*8	892261
ISDN-PRI	884060	INF+M T1E1*8	892360
ADPCM 64	887160	INF T1*2	892460
IMUX	8880	Alarm Cards	
IPR 10B2	883060	ALR 4+4	840160
IPR 10BT	883160	ALR 4+3PF	840260
		ALR 28+14	840360

A.7 FCC Requirements

The three tables below outline the FCC Registration Information for Part 1, Part 2 and Part 3 for these system cards.

Reg. Status	MTS/WATS Interfaces	Model #	Ringer Equiv. Number	SOC	Network USOC	Canadian Jacks
M	02LS2	FXO 2W*8-6	0.4B (ac), 0.0 (dc)	-----	RJ11X	CA11X
M	02GS-2	FXO 2W*8-6	0.4B (ac), 0.0 (dc)	-----	RJ11X	CA11X
Reg.	02LS2	INF+M T1E1	0.8B (ac), 0.0 (dc)	-----	RJ11X	CA11X

Reg.	Analog PL Interfaces	Model #	SOC	Network USOC	Canadian Jacks
Reg.	0L13C	FXS 2W*8-6	9.0F	RJ21X	CA21A
Reg.	02LR2	FXS 2W*8-6	9.0F	RJ21X	CA21A
Reg.	TL11M	FXS 2W*8-6	9.0F	RJ2EX	CA2EA
Reg.	TL12M	FXS 2W*8-6	9.0F	RJ21FX	CA2FA
Reg.	TL11E	E&M 2W*8, E&M 4W*8	9.0F	RJ2EX	CA2EA
Reg.	TL12E	E&M 2W*8, E&M 4W*8	9.0F	RJ2FX	CA2FA
Reg.	TL31M	E&M 2W*8, E&M 4W*8	9.0F	RJ2GX	CA2GA
Reg.	TL32M	E&M 2W*8, E&M 4W*8	9.0F	RJ2HX	CA2HA
Reg.	TL31E	E&M 2W*8, E&M 4W*8	9.0F	RJ2GX	CA2GA
Reg.	TL32E	E&M 2W*8, E&M 4W*8	9.0F	RJ2HX	CA8HA

Reg.	Digital Interfaces	Model #	SOC	Network USOC	Canadian Jacks
Reg.	04DU9-BN	WAN SINGLE, WAN DUAL*	6.0Y	RJ48	CA81A
Reg.	04DU9-DN	WAN SINGLE, WAN DUAL*	6.0Y	RJ48	CA81A
Reg.	04DU9-1KN	WAN SINGLE, WAN DUAL*	6.0Y	RJ48	CA81A
Reg.	04DU9-1SN	WAN SINGLE, WAN DUAL*	6.0Y	RJ48	CA81A
Reg.	04DU9-1ZN	WAN SINGLE, WAN DUAL*	6.0Y	RJ48	CA81A
Reg.	04DU9-BN	WAN SINGLE, WAN DUAL**	6.0P	N/A	---
Reg.	04DU9-DN	WAN SINGLE, WAN DUAL**	6.0P	N/A	---
Reg.	04DU9-1KN	WAN SINGLE, WAN DUAL**	6.0P	N/A	---
Reg.	04DU9-1SN	WAN SINGLE, WAN DUAL**	6.0P	N/A	---
M	04DU5-24	OCU-DPx2	6.0F	RJ48	CA81A
M	04DU5-48	OCU-DPx2	6.0F	RJ48	CA81A
M	04DU5-56	OCU-DPx2	6.0F	RJ48	CA81A
M	04DU5-96	OCU-DPx2	6.0F	RJ48	CA81A

* with CSU module ** with DSX module

A.8 UK Requirements

Clearance (mm)	Creepage (mm)	Voltage Used or Generated By Host or Other Cards
2.0	2.4 (3.8)	Up to 50Vrms or VDC
2.6	3.0 (4.8)	Up to 125Vrms or VDC
4.0	5.0 (8.0)	Up to 250Vrms or VDC
4.0	6.4 (10.0)	Up to 300Vrms or VDC
For a host or other expansion card fitted in the host, using or generating voltages <i>greater</i> than 300V (rms or DC), advice from a competent telecommunications safety engineer must be obtained before installation of the relevant equipment.		Above 300Vrms or VDC

A.9 Year 2000 Compliance

All products are compliant with Bellcore Requirements GR-2945, *Year 2000 Generic Requirements: Systems and Interfaces*. The following key points about this compliance are noteworthy:

1. All dates displayed or printed by the Integrated Access System are used for reference purposes only. No calculations, except leap year calculations (see number 3 below), are based on these dates.
2. The displayed or printed dates use implicit century indications. In other words, years are displayed as two digit numbers and because the dates are assumed current, or near current, the century is implied. Since all dates are shown for reference purposes only, and are normally used by maintenance personnel to monitor system performance over a short time frame, the implicit century indication presents no confusion, miscalculation or potential ambiguity.
3. Leap year calculations are handled correctly under all circumstances except one: century years not evenly divisible by 400 will be falsely computed as leap years. The year 2000 is evenly divisible by 400 and the Integrated Access System correctly computes it as a leap year. The years 2100, 2200, 2300, 2500, etc. are all non-leap years, but the Integrated Access System will computer them as leap years.
4. Newer releases of the Integrated Access System software (e.g. release 5.2, etc.) will correctly accept the system set-up entry of February 29 as a valid date when the associated value for the year indicates a leap year. Release prior to February 12, 1997 will not accept that date as a valid entry under any condition, leap year or non-leap year. In all releases, operating Integrated Access System software will properly roll leap year dates from February 28th to the 29th and then March 1 without error.

Appendix B

Error Messages

B.1 Introduction

This appendix lists the Integrated Access System error messages. One of these messages may appear at the bottom of the screen when you enter a command, indicating that the system did not perform the requested action. This condition may have been caused by an operator error, absence of a card in the system, or other condition. If an error message appears, take the appropriate corrective action. For convenience, the system error messages are listed alphabetically.

‘0000’ invalid for E, reverted to original.

The sequence 0000 is not a valid ABCD signaling sequence on E1 links. Choose a different ABCD sequence for E1 signaling conversion to/from T1 format.

A name must be assigned to Circuit ID field.

You must enter a name for the circuit before attempting this operation. Go to the Circuit ID field, type the desired name, and save it.

ADPCM card is not installed or rdnt.

An ADPCM card is not present in the system, or you chose a redundant ADPCM card for data compression. Install an ADPCM card, or selected a non-redundant card.

ADPCM doesn’t support WAN switch.

WAN redundancy is not available if ADPCM card is used in the system.

Alarm Card can’t be active with dialing.

An External Alarm card cannot be used when HSU cards are programmed for ISDN dialing. Remove this card.

All available PVCs are already taken.

The number of PVCs available on the FRAD Card Main Screen has been exceeded by the number of PVCs assigned on the PVC Screen. Assign a number of PVCs on the PVC Screen that is lower than the quantity chosen in the Main Screen.

All blank prt repot.

You chose the empty option setting for all four elements of the Print Alarm on the Interface Card. This combination of settings is invalid and cannot be saved. Choose the proper option settings for these elements.

ASync/5 databits must have 2 stop or parity.

You have assigned an SRU card port to an asynchronous circuit with 5 data bits, one stop bit, and no parity. This is an invalid combination of option settings. Either choose two (2) stop bits, or enable parity on that port.

ATM PHY is not active.

The physical ATM port is not active.

B-channels must be allocated.

You are trying to activate an ISDN PRI D-channel that has no assigned B-channels. Assign B-channels to the D-channel.

Bad routing format.

The telephone numbers used for the ISDN-PRI routing table are not formatted correctly. Re-enter these numbers in the proper format.

Bad Service number format.

ISDN-PRI Server numbers must have two digits. The valid service number range is from 01 to 99.

BCH is not supported in XCON.

You cannot use BCH error correction on an OCU-DP card in systems with cross-connect WAN cards.

Both WAN's cannot be in test mode.

You cannot use the test option on both sides of a cross-connect simultaneously.

Broadcast cannot be looped back.

You cannot activate a loopback on a broadcast cross-connection.

Bus cannot be looped back.

You cannot assign a multirate HSU port to more than 30 time slots of a WAN E1 link or 24 time slots on a T1 link.

Call manufacturer for availability.

You are trying to assign too many D-channels to the current ISDN-PRI card. Upgrade the card in your system, or replace it with one capable of supporting the desired number of D-channels. Call Technical Support for assistance.

Cannot be STDBY while BERT test is running.

You cannot change a port from the activ (active) state to the stdby (standby) state while the Bit Error Rate Tester (BERT) is running. You must end the BERT test first.

Cannot define any more PVC connections.

The maximum number of PVC connections has been reached.

Cannot define any more PVC endpoints.

The maximum number of PVC endpoints has been reached.

Cannot define any more XCON circuits.

The maximum number of cross-connect circuits is 99.

Can NOT delete circuit while test is active.

You must end the test in progress before deleting the circuit.

Cannot do it in Viewer mode.

You are logged in under the Viewer password, but that level of access does not allow you to perform the desired operation. Log out of the system, log back in under the Operator or Manager password, and repeat the command. Or, perform an operation that is permitted by the Viewer access level.

Cannot exceed 32 TS's for ports 1-32 or 33-64.

Each set of 32 ports can have one time slot (total of 32 time slots).

Cannot have REMOTE and LOCAL loopbacks.

You cannot place the card port in both a local loopback and a remote loopback simultaneously.

Cannot insert errors without BERT running.

You must start BERT testing before inserting bit errors.

Cannot switch non-compatible WANs.

The current WAN card arrangement does not support redundant WAN switching.

Cannot switch to a non-operational WAN.

You cannot switch to the selected WAN card because it is out of service.

Cannot talk to NTU while BERT is running.

You must stop the BERT test before accessing the NTU.

Cannot use the same TS on different WAN.

You cannot assign an SRU card port to the same time slot on different WAN ports.

Can't define any more IP entries.

The maximum number of IP entries has been reached.

Can't initialize modem.

The Interface card modem was not initialized.

Card already installed.

You cannot use the Configuration option on an occupied chassis slot.

Card does not respond.

The card is not responding to your commands. Remove the card from the chassis, plug it back in again, and repeat the command. If the message appears again, replace the card.

Card has broadcast/monitor links.

You cannot place the HSU card in standby when it has active broadcast lines.

Card is not available.

You cannot test the card because it is faulty. Replace the card.

Channel test is available from WAN XCON screen.

To test a cross-connected voice circuit, go to the Cross-Connect Screen.

Circuit is already used, no subaddress allowed.

You cannot assign the same circuit number to different ports in the FRAD User Port screen.

Circuit name must be entered.

You must enter a name for the cross-connect circuit before attempting this command.

Combined ADPCM rate must equal 64K.

You cannot assign a 40 kbps and a 32 kbps channel to the same ADPCM 64 kbps engine. The only valid combinations are 40 kbps + 24 kbps, 32 kbps + 32 kbps, and 24 kbps + 40 kbps.

Command rejected. Switch in progress.

The command was not executed because a redundancy switch is in progress.

Config. changes must be made from primary WAN.

You cannot make configuration changes to a redundant WAN port. This is allowed only on primary WAN ports.

CONG stat is not available for FRAD port.

Frame relay packet congestion data is not available for this FRAD port.

Cumulative bandwidth exceeds 115.2K.

You cannot assign more than 115.2 kbps of aggregate bandwidth to an SRU card. Be sure the sum-total rate of all card ports does not exceed 115.2 kbps.

Current CPU does not support redundancy.

The selected CPU card does not support redundancy. If the system has two CPUs, be sure they are both 8803s.

D-channel is active.

You cannot change WAN parameters because ISDN D-channel associated with it is still active.

Dialing is not available with Alarm Card.

If an External Alarm card is present in the system, you cannot use dial triggers for the HSU card. Remove the External Alarm card first.

ds0-n available only with 64K rate.

You cannot generate a DS0 time slot (ds0-n) loopback on an OCU-DP port with a data rate of less than 64 kbps. This is possible only on ports operating at 64 kbps and higher.

Duplicate prt report element.

You have asked the Print Alarms option to print the same element twice.

Each WAN can have only one d-chan.

You cannot assign two D-channels to the same WAN port.

Empty field is not allowed.

You cannot assign a blank password on the CPU Card Main Screen. Always enter alphanumeric characters.

Empty slot.

You cannot access the card or associated screen because it is not plugged into the chassis.

ENETBRI/PRI card is not installed or config.

An Ethernet BRI/PRI card is not present in the system, and is not configured.

Engine pair must have same ADPCM WAN and TS.

You must assign each pair of ADPCM engines (1-2, 3-4, 5-6, etc.) to the same WAN port and time slot.

ERR COR bch_ts must be larger than TS.

For BCH error correction, you must assign a separate WAN time slot that is numerically higher than the time slot carrying the normal data.

Error correction is not supported.

Error correction is not supported on the five-port or ten-port OCU-DP card. Or, majority voting (maj-v option setting) error correction is not supported for data rates higher than 9.6 kbps. Use bch error correction instead, or do not use error correction.

ERROR found in the RESTORE file.

The system restoral failed due to a software error. Repeat the restoral, and call Technical Support if this message reappears.

Field can NOT be MODIFIED.

You cannot edit this field.

FR circuit is not defined.

You cannot assign a user circuit for an undefined Frame Relay PVC.

FR port and DLCI must be unique.

The Frame Relay port and DLCI must form a unique address for each PVC.

FR port is not active.

You cannot activate a PVC on an inactive Frame Relay port.

Group 'A' is not allowed for slcd4.

You cannot use trunk group A in the slcd4 mode.

Group already taken.

This group is already assigned.

Illegal address and mask combination.

The combination of IP address and mask numbers you chose is invalid. Change either the IP address or mask number.

Illegal IP Mask.

The IP netmask number you chose is invalid.

Intf. ID must be uniquely identified.

The ISDN PRI card must have a different two-digit number for each WAN port used for B-channels.

Invalid character in Node Id.

The only valid characters for a Node ID are alphanumeric characters and the underscore.

Invalid date/time format.

You have entered an invalid date or time.

Invalid Dlci value.

The DLCI number you chose is invalid.

Invalid endpoint name.

The endpoint name you chose is invalid.

Invalid IP address.

The IP address you chose is invalid.

Invalid IP netmask.

The IP netmask you chose is invalid.

Invalid parameters for ADPCM.

You cannot use ADPCM on voice cards that use A-Law coding. This is only allowed on mu-Law voice cards.

Invalid password for this command.

You cannot use the debug command from the System Test and Debug Screen without the proper password authorization.

Invalid secondary clock format.

You cannot assign an external clock source as the secondary system clock.

Invalid SR TS.

You cannot assign an SRU card subrate port to a WAN time slot that does not have enough room on the subrate time slot for that much bandwidth. For example, if you have a port with b-5 framing occupying subrate time slots 1 to 4, you cannot also assign a fifth port whose bandwidth exceeds 9.6 kbps to subrate time slot 5.

Invalid sub address.

You cannot assign the same subaddress number to two different user ports on the FRAD Card Main Screen.

Invalid Timeslot.

When assigning time slots to user voice and data ports, you must choose time slot number 1 to 24 for a WAN T1 port, or 1 to 31 for a WAN E1 port.

Invalid WAN/SRVR.

You cannot assign services to an unavailable WAN or Server card.

IP Address must be unique.

The IP address is already assigned.

ISDN connected circuit.

You cannot place an HSU card port with an active ISDN call in standby. Wait for the call to end.

ISDN, FRAD, ADPCM do not support WAN switch.

WAN redundancy is not available if any of those cards are used in the system.

Local LB & Test Pattern can't be ON together.

You cannot perform a loopback with a test pattern applied, and you cannot apply a test pattern if a loopback is active.

MAJ EC is not available with RATE> 9.6.

You cannot use majority-vote error correction on an SRU card port with a Rate higher than 9.6 kbps. Use bch error correction instead, or disable error correction.

Mode cannot be changed when any ts are allocated.

You cannot change the WAN card mode from d-i (drop and insert) to term (terminal), or vice versa, when time slots are occupied. First, make all time slots available.

Modification can't be saved while test is active.

You cannot make changes in this screen while a test is in progress.

Module is not installed.

You cannot use the Configuration option on a WAN port that doesn't have a CSU, DSX/CEPT, or HDSL plug-in module attached. Be sure to install the proper module(s) on the WAN card. For HDSL interfacing, an 8011 WAN Card is required.

Must be in terminal mode.

You cannot use the Configuration option on a WAN card in the drop-and-insert mode.

Must have clean WAN.

You cannot use the Configuration option on a WAN card whose time slots are already occupied.

Must have OOS status.

You cannot delete a card that has not been removed from the system. Remove the card first.

Must have WAN card installed.

You cannot use the Configuration option on an uninstalled WAN card. Install the card first.

N392 must be less than or equal to N393.

N392 determines the amount of errors that will be tolerated during the amount of events assigned in N393. FRAD rules require that N392 be less than or equal to N393.

No changes for selected switch.

When connected to an ISDN office switch, you cannot change the status of a B-channel.

No changes while BERT is running.

You cannot change the port configuration while Bit Error Rate Testing is active. Turn the test mode off before making your changes.

No d-i mode for this slot.

In a redundant cross-connect system, you cannot assign the drop-and-insert (d-i) mode to the WAN card in slot W3, which holds the redundant WAN card.

No historical alarms.

You have selected the History command in the Alarm Screen, but no alarms exist in that log.

No more profiles allowed.

You cannot assign more than 16 call profiles to the Interface Card.

No more than 1 ts allowed.

You cannot assign more than one WAN time slot to a FRAD circuit.

No more than 2 ts allowed.

The Frame Relay PVC circuit cannot exceed 128 kbps (two 64 kbps time slots).

No more than one BERT test per BRI card.

You cannot perform more than one BERT test on each BRI card.

No more than two WANs in BERT test are allowed.

You can place only two WAN ports in the BERT test mode simultaneously.

No NFAS for selected switch.

The ISDN office switch does not accept NFS B-channel assignments.

No second net-lb allowed when bw = 115.2 kbps.

You cannot activate more than one network loopback at a time on an SRU card port.

No timeslot(s) specified.

You cannot activate a user card that doesn't have any WAN time slots assigned to it.

No Voice Compress. WAN card using ALL resources.

No ADPCM card is currently available for voice compression.

Not applicable for S/T card.

This does not apply for a BRI S/T card.

Not enough available U-slots.

You cannot use the Configuration option with less than three available user card slots in the chassis for T1 operation, or four available user card slots for E1 operation.

Not implemented yet.

You cannot use a feature or function that is not yet released. This message normally appears on software versions for beta testing.

Not supported.

This command is currently not supported by the system.

Number of TS from must be equal to TS to.

You cannot assign a time slot cross-connection with an unequal number of “from” (source) and “to” (destination) time slots.

Only B-chan can be controlled.

You cannot update or delete a regular cross-connect circuit from the Cross-Connect Broadcast Screen.

Only broadcast/data type can be controlled.

You cannot update or delete a regular cross-connect circuit from the Cross-Connect Broadcast Screen.

Only network or data type can be broadcasted.

You cannot broadcast a Broadcast circuit from the Cross-Connect Broadcast Screen.

Only one ADPCM redundant in the system.

You cannot make more than one ADPCM a redundant card in the system.

Only one port can be at 128K.

You cannot configure more than one port of the card for 128 kbps.

Only U-slots can be configured.

You cannot use the Configuration option for the P slots, C slots, or I slot of a chassis.

Only w1-1 or w1-2 are supported.

You can use the Configuration option only on WAN ports W1-1 and W1-2.

Parameters are not saved.

You have selected the Main command from the bottom of the screen without first saving your changes. Press “s” to invoke the Save command first.

Parameters have been saved.

You have made changes to the card and typed “s” to invoke the Save command. (This is a normal message, it always appears when you type “s” to save changes.)

Performance statistics is not available in slc96.

You cannot obtain performance statistics for a WAN port in the slc96 mode.

Performance statistics not available.

You cannot obtain performance statistics for this card or port.

Phone number must be unique.

The primary phone number on an HSU card must be unique.

Port already configured for Remote Terminal.

This port is already configured for use with a remote terminal.

Port has PVC(s) allocated. No changes allowed.

You cannot deactivate a Frame Relay port with active PVCs.

Port is in use.

You cannot make any changes to an active port.

Port is not active.

You cannot use the Hangup option on an HSU card port in the standby state.

Port is not configured for ASCII.

This port is not configured for ASCII operation.

Port is not configured for TCP/IP.

This port is not configured for TCP/IP operation.

Primary WAN is not operational.

You cannot switch from a redundant WAN port back to a primary WAN port if the primary port is still not operational.

Profile has to be loaded first.

You cannot use the Dial command in the HSU Card Main Screen without first loading a call profile.

Profile Id was not found.

Upon using the Load command in the HSU Card Main Screen, you requested a non-existing call profile from the Interface card.

PVC has user circuits active. No changes allowed.

You cannot deactivate a Frame Relay PVC with active user circuit(s).

PVC name must be entered.

You must enter a PVC name before executing this command.

PVC name must be unique.

The current PVC name is already in use. Enter a different name.

RATE = 19.2 must have DATA = 8 for adpcm or hlink.

If you set the SRU card port rate to 19.2 kbps, you also must set the number of data bits for that port to 8.

Redundancy requires WAN Model 8014 in Slot W4.

Your system must have an 8014 WAN Card in slot W4 for WAN redundancy operation.

Redundancy switchover is complete.

You have asked the system to switch to the redundant WAN card, and the switchover was successfully completed. (This is not an error message; it normally appears after you initiate the switchover.)

Redundant CPU.

The current CPU card is the redundant card.

Redundant WAN is taken already.

You cannot switch to the redundant WAN card in slot WAN-4 if it is already in use from a previous WAN card switch.

Remote session active. Can't change setting.

You cannot change this setting because a remote operator has accessed the system and is controlling it. Wait for that operator to log off and disconnect.

Restricted field.

You cannot access the Superuser password field on the CPU Card Main Screen. This password is factory-assigned.

Selected ADPCM can be primary only.

The current ADPCM card cannot be a redundant card.

Selected circuit is not primary.

The current circuit is redundant, not a primary circuit.

Selected circuit is under the test already.

The current circuit is already being tested.

Service table is currently used by profile.

You cannot change the service table on the ISDN configuration screen when the service is selected and stored in an Interface card call profile.

Simultaneous loopback tests not allowed.

You cannot activate two or more loopbacks at the same time.

SNMP Options not available on this CPU.

The current CPU card does not support SNMP configuration.

Specify Sys Ph# before activating REMOTE vt100.

You must enter the Integrated Access System's phone number before a remote operator can connect to the system.

SR TS overlapping.

The subrate circuit assigned does not allow enough space for a previously assigned circuit on the same subrate time slot. For example, if you have a 19.2 kbps device on subrate time slot 1 in b-5 framing, you cannot assign another 19.2 kbps circuit to subrate time slot 2, because the circuit on 1 actually occupies subrate time slots 1 and 2. You must therefore assign that other circuit to subrate time slot 3 or 4.

Switch request sent to card.

The system has sent your redundancy switchover command to the associated card.

Switchover must be made from the primary WAN.

You cannot switch to a redundant WAN port from another redundant WAN port. You can only switch from a primary port to a redundant port.

Test function is not available.

The selected test is not available on the current card.

Test in progress. No changes from this screen.

You cannot change any settings in this screen while a card test is in progress.

Test is not available in slc96.

You cannot perform this test on an slc96 WAN port.

This option not available on INTF-2.

You cannot perform this action on the current Interface card.

Timeslot has different framing.

You cannot assign different subrate framing to the same WAN time slot. For example, if you have a port with b-5 framing on one WAN time slot, you cannot assign a different port with b-10 framing to that time slot.

TS 16 cannot be used with v&s.

You cannot assign a voice circuit with signaling to time slot 16 of an E1 WAN port.

TS 16 is already in use.

You cannot assign time slot 16 of a CEPT E1 WAN port programmed for cas.

TS Connection must be specified.

You must specify a time slot connection for the WAN circuit.

TS(s) cannot be allocated.

You cannot assign a voice cross-connect to time slot 16 of a CEPT E1 WAN port.

Unit controlled by FEC.

The user card is controlled by forward error correction.

Units in pair must have the same source.

You must configure the Source parameter of User units on a FRAD card in pairs.

Voice CPU is not responding.

The voice CPU is not working. Power down the system, then power it up again.

WAN must be active (no loopback) to run BERT test.

You must turn off all WAN loopbacks before starting a BERT test on a WAN port.

WAN must have SLC format.

The WAN port must be configured for slc96.

Xconnect table can be accessed from primary WAN.

You cannot access the WAN cross-connect information from a redundant WAN port. Do this from a primary WAN port instead.



Appendix C

Pinouts

C.1 Introduction

This appendix describes the pinouts of the card connectors used to attach circuits and devices to the network. The number and type of connectors needed will vary with the card installed.

C.2 Interface Cards

C.2.1 INF-E Card (892260)

C.2.1.1 INF-E Card External Connector and Pinouts

Figure C-1 shows the INF-E card front panel, which has several jacks.

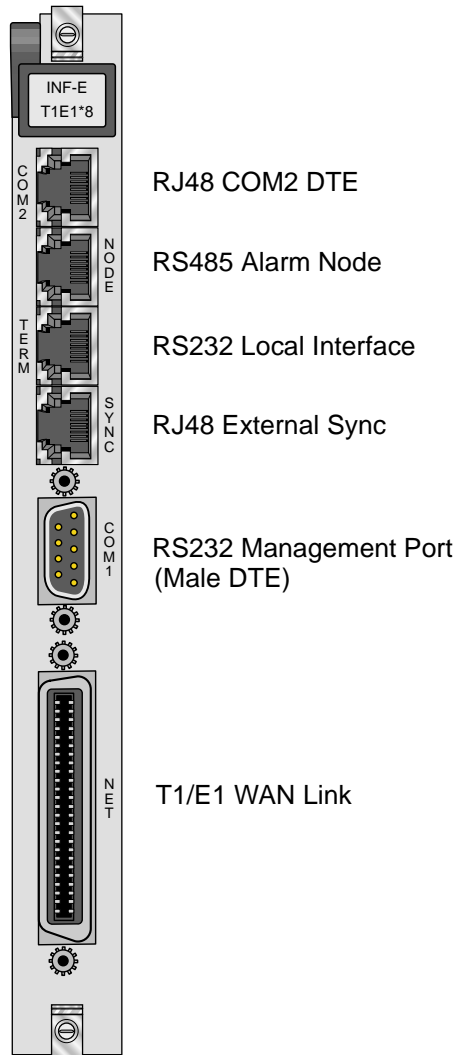

Figure C-1. INF-E Card Connectors (892260)

Using the COM2 Port

The COM2 jack provides an RJ48 DTE connection to an external DTE device. Figure C-2 shows the COM2 jack pin locations, and Table C-1 lists the signal pinouts.

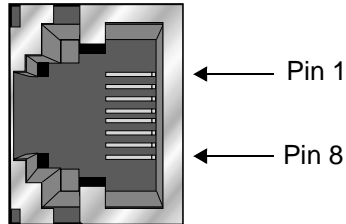

Figure C-2. RJ48 (COM2) Jack

Table C-1. RJ48 (COM2) Jack Signal Pinouts

RJ48 Pin	Designation	Function
1	RI	Ring Indicator (from DTE)
2	RLSD	Received Line Signal Detect (to DTE)
3	DTR	DTE Ready (from DTE)
4	GND	Signal Ground
5	RD	Receive Data (to DTE)
6	TD	Transmit Data (from DTE)
7	CTS	Clear to Send (to DTE)
8	RTS	Request to Send (from DTE)

Using the RS-485 Node Port

The RS-485 Node port allows you to activate external alarms that alert on-site personnel to critical situations. Using the ACO function will keep the alarm active until it is manually cleared from a control terminal.

Connect the NODE jack of the INF-E card to the external alarm equipment. This is another RJ-48 jack; it provides a set of form-C relay contacts to the external alarm equipment. Figure C-3 shows the pin locations on this jack, which are the same as the COM2 jack. Table C-2 lists the associated signal pinouts.

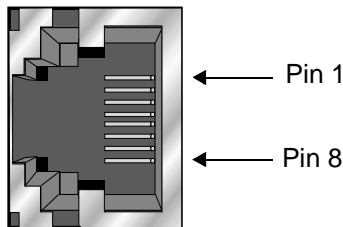

Figure C-3. RJ48 Node Jack

Table C-2. RJ48 (NODE) Jack Signal Pinouts

RJ48 Pin	Designation	Function
1	---	not used
2	---	not used
3	ANC	Alarm on Open Condition
4	ANO	Alarm on Closed Condition
5	ACOM	Alarm Common Lead (Source)
6	---	not used
7	---	not used
8	GND	Chassis Ground

The alarm interface is activated by the ACO setting. This will activate the device when a designated alarm occurs. See chapter on Alarms to review the conditions and settings necessary to enable this feature.

Connect pins 4 and 5 to provide an open relay contact to the external device upon occurrence of an alarm. Or, connect pins 3 and 5 for a relay contact closure upon alarm.

Using the Control Terminal Port

The RS-232 Control Terminal Port allows you to connect the Integrated Access System to a local VT100-compatible terminal, which you can then use to control the system. This port is configured as a DCE interface.

Connect your local terminal to the TERM jack of the INF-E card. This is an RJ-48 jack in compliance with EIA-561. Figure C-4 shows the pin locations on this jack, and Table C-3 lists the signal pinouts.

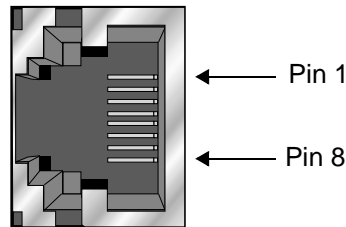

Figure C-4. RS232 (TERM) Local Interface Jack

Table C-3. RS232 (TERM) Jack Signal Pinouts

RS232 Pin	Function	Direction
4	Signal Ground	N/A
5	Receive Data	To local terminal
6	Transmit Data	To access system
All other pins are open.		

Using the External Sync Port

The External Sync Port allows you to connect up to two external clocking sources from the external timing clock panel to an INF-E Card.

The external sync port is provided on the SYNC jack of the card. Connect the external clock sources to this jack, which accepts RS-485 signals. Figure C-5 shows the jack pin locations, and Table C-4 lists the signal pinouts.

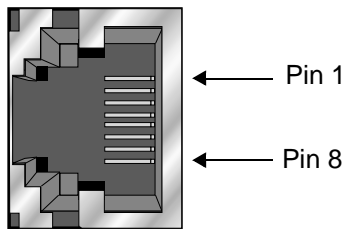

Figure C-5. RS485 External Sync Jack

Table C-4. RS485 External (SYNC) Jack Signal Pinouts

Pin Number	Designation	Description
1	R1	RX from Clock Source (Ext 1)
2	T1	RX from Clock Source (Ext 1)
7	R2	RX from Clock Source (Ext 2)
8	R2	RX from Clock Source (Ext 2)

Using the Management Port

Connect an external computer or other device to the jack for alarm reporting locally. This is a DB-9 male connector. Figure C-6 shows the connector pin orientation, and Table C-5 lists the signal pinouts and directions.

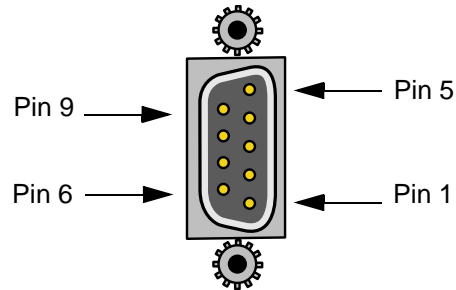

Figure C-6. Management Connector

Table C-5. Management Connector Signal Pinouts

Signal Name	DB-9 Pin	Function	Direction
RLSD	1	Receive Line Signal Detect	Input
RD	2	Receive Data	Input
TD	3	Transmit Data	Output
DTR	4	Data Terminal Ready	Output
S GND	5	Signal Ground	N/A
DSR	6	Data Set Ready	Input
RTS	7	Request to Send	Output
CTS	8	Clear to Send	Input
RI	9	Ring Indicator	Input

WAN Port Connections

The NET jack allows you to connect the system's WAN card ports to incoming and outgoing T1/E1 lines. This jack (Figure C-7) is a 50-pin, Amphenol-type connector. Table C-6 lists the signal pinouts for the NET jack.

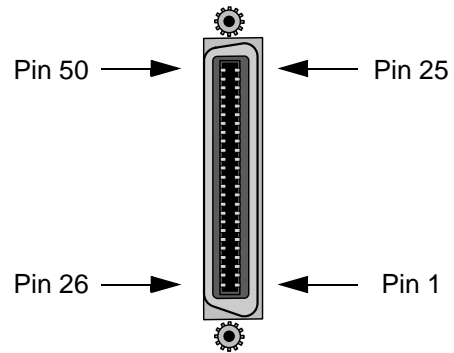

Figure C-7. NET Jack

Table C-6. NET Jack Signal Pinouts

WAN Link	Designation	Pin	Function
WAN 1-1	T1	47	Rx from Network
WAN 1-1	RI	22	Rx from Network
WAN 1-1	T	48	Tx to Network
WAN 1-1	R	23	Tx to Network
WAN 1-2	T1	44	Rx from Network
WAN 1-2	RI	19	Rx from Network
WAN 1-2	T	45	Tx to Network
WAN 1-2	R	20	Tx to Network
WAN 2-1	T1	41	Rx from Network
WAN 2-1	RI	16	Rx from Network
WAN 2-1	T	42	Tx to Network
WAN 2-1	R	17	Tx to Network
WAN 2-2	TI	38	Rx from Network
WAN 2-2	RI	13	Rx from Network
WAN 2-2	T	39	Tx to Network
WAN 2-2	R	14	Tx to Network
WAN 3-1	TI	35	Rx from Network
WAN 3-1	RI	10	Rx from Network
WAN 3-1	T	36	Tx to Network
WAN 3-1	R	11	Tx to Network
WAN 3-2	TI	32	Rx from Network
WAN 3-2	RI	7	Rx from Network
WAN 3-2	T	33	Tx to Network
WAN 3-2	R	8	Tx to Network
WAN 4-1	TI	29	Rx from Network
WAN 4-1	RI	4	Rx from Network
WAN 4-1	T	30	Tx to Network
WAN 4-1	R	5	Tx to Network
WAN 4-2	T1	26	Rx from Network
WAN 4-2	RI	1	Rx from Network
WAN 4-2	T	27	Tx to Network
WAN 4-2	R	2	Tx to Network

All other pins are open. Also WAN cards 1 through 4 are installed in slots W1 through W4, respectively, of all chassis models.

C.2.2 INF+M Card (892360)

C.2.2.1 INF+M Card External Connector and Pinouts

Figure C-8 shows the INF+M card front panel, which has several jacks.

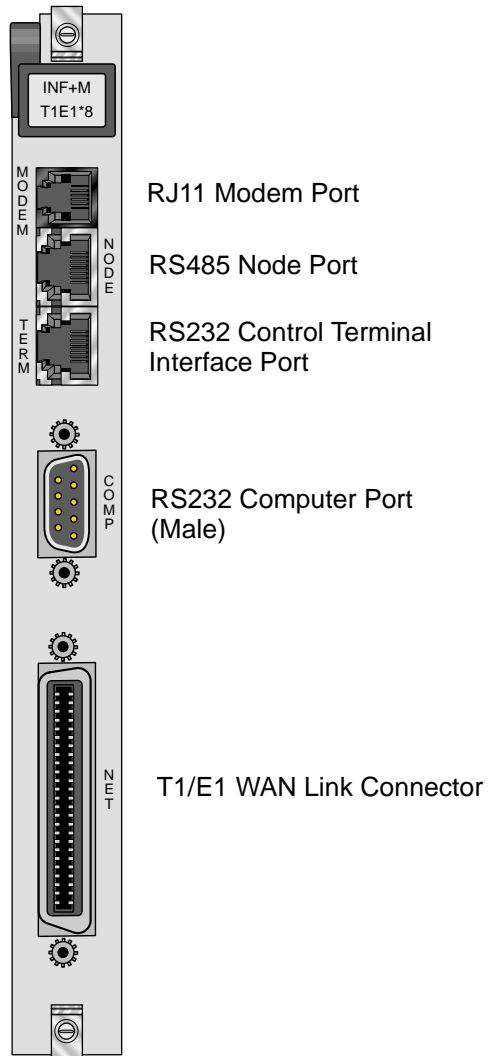

Figure C-8. INF+M Card Jacks (892360)

Using the Modem Port

The internal modem of the INF+M card is an asynchronous, ITU-T V.22bis modem. It allows remote access to the terminal interface and automatic reporting of alarm messages to a remote device. Table C-7 lists the specifications of the modem.

Table C-7. Modem Specifications

Parameter	Rating
Compatibility	ITU-T V.22 bis
Modulation	16-point QAM
Line Interface	2-wire, 600 ohms
Approval	FCC Part 68
Equalization	Receive: automatic adaptive Transmit: fixed compromise
Receiver Sensitivity	ON to OFF threshold: -45 dBm OFF to ON threshold: -48 dBm
Dialing Mode	DTMF
Speed	2400 bps, asynchronous
Code Set	8-bit data, one stop bit, no parity
Ringer Equivalence	0.2 A
Transmit Level	-9.5 dBm

Connect the MODEM jack to a phone line, using a modular telephone cord. This is an RJ-11 jack; it uses only pins 3 (Tip) and 4 (Ring). Figure C-9 shows the jack pin orientation.

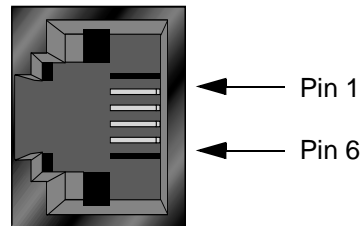

Figure C-9. MODEM Jack

The modem automatically answers incoming calls. A remote operator can press the <Enter> key to display the log-in screen. After entering a valid password, that operator has complete access to the user interface.

To disconnect, the remote operator logs off and then hangs up. The modem automatically resets and waits for the next call.

Using the RS-485 Node Port

The RS-485 Node port allows you to activate external alarms that alert on-site personnel to critical situations. Using the ACO function will keep the alarm active until it is manually cleared from a control terminal.

Connect the NODE jack of the INF+M card to the external alarm equipment. This is another RJ-48 jack; it provides a set of form-C relay contacts to the external alarm equipment. Figure C-10 shows the pin locations on this jack, which are the same as the COM2 jack. Table C-8 lists the associated signal pinouts.

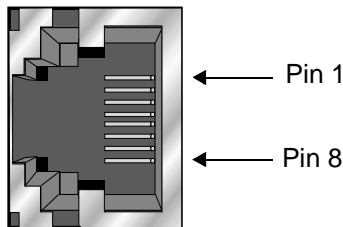

Figure C-10. RJ48 (NODE) Jack

Table C-8. RJ48 (NODE) Jack Signal Pinouts

RJ48 Pin	Designation	Function
1	---	not used
2	---	not used
3	ANC	Alarm on Closed Condition
4	ANO	Alarm on Open Condition
5	ACOM	Alarm Common Lead (Source)
6	---	not used
7	---	not used
8	GND	Chassis Ground

The alarm interface is activated by the ACO setting. This will activate the device when a designated alarm occurs. See chapter on Alarms to review the conditions and settings necessary to enable this feature.

Connect pins 4 and 5 to provide an open relay contact to the external device upon occurrence of an alarm. Or, connect pins 3 and 5 for a relay contact closure upon alarm.

Using the Control Terminal Port

The RS-232 Control Terminal Port allows you to connect the Integrated Access System to a local VT100-compatible terminal, which you can then use to control the system. This port is configured as a DCE interface.

Connect your local terminal to the TERM jack of the INF-E card. This is an RJ-48 jack in compliance with EIA-561. Figure C-11 shows the pin locations on this jack, and Table C-9 lists the signal pinouts.

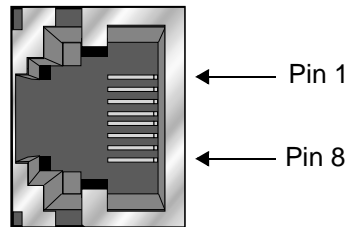

Figure C-11. RS232 (TERM) Local Interface Jack

Table C-9. RS232 (TERM) Jack Signal Pinouts

RS232 Pin	Function	Direction
4	Signal Ground	N/A
5	Receive Data	To local terminal
6	Transmit Data	To access system
All other pins are open.		

Using the Management Port

Connect an external computer or other device to the jack for alarm reporting locally. This is a DB-9 male connector. Figure C-12 shows the connector pin orientation, and Table C-10 lists the signal pinouts and directions.

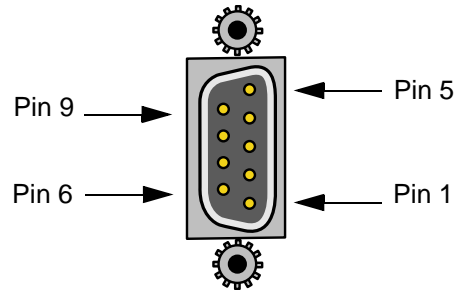

Figure C-12. Management Connector

Table C-10. Management Connector Signal Pinouts

Signal Name	DB-9 Pin	Function	Direction
RLSD	1	Receive Line Signal Detect	Input
RD	2	Receive Data	Input
TD	3	Transmit Data	Output
DTR	4	Data Terminal Ready	Output
S GND	5	Signal Ground	N/A
DSR	6	Data Set Ready	Input
RTS	7	Request to Send	Output
CTS	8	Clear to Send	Input
RI	9	Ring Indicator	Input

WAN Port Connections

The NET jack allows you to connect the system's WAN card ports to incoming and outgoing T1/E1 lines. This jack (Figure C-13) is a 50-pin, Amphenol-type connector. Table C-11 lists the signal pinouts for the NET jack.

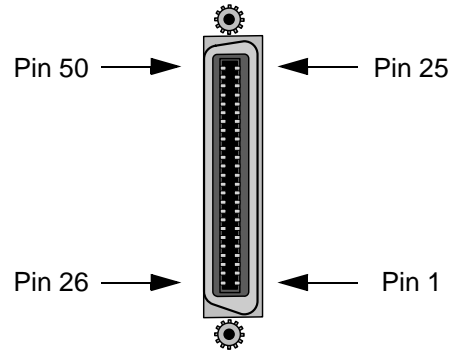

Figure C-13. NET Jack

Table C-11. NET Jack Signal Pinouts

WAN Link	Designation	Pin	Function
WAN 1-1	TI	47	Rx from Network
WAN 1-1	RI	22	Rx from Network
WAN 1-1	T	48	Tx to Network
WAN 1-1	R	23	Tx to Network
WAN 1-2	TI	44	Rx from Network
WAN 1-2	RI	19	Rx from Network
WAN 1-2	T	45	Tx to Network
WAN 1-2	R	20	Tx to Network
WAN 2-1	TI	41	Rx from Network
WAN 2-1	RI	16	Rx from Network
WAN 2-1	T	42	Tx to Network
WAN 2-1	R	17	Tx to Network
WAN 2-2	TI	38	Rx from Network
WAN 2-2	RI	13	Rx from Network
WAN 2-2	T	39	Tx to Network
WAN 2-2	R	14	Tx to Network
WAN 3-1	TI	35	Rx from Network
WAN 3-1	RI	10	Rx from Network
WAN 3-1	T	36	Tx to Network
WAN 3-1	R	11	Tx to Network
WAN 3-2	TI	32	Rx from Network
WAN 3-2	RI	7	Rx from Network
WAN 3-2	T	33	Tx to Network
WAN 3-2	R	8	Tx to Network
WAN 4-1	TI	29	Rx from Network
WAN 4-1	RI	4	Rx from Network
WAN 4-1	T	30	Tx to Network
WAN 4-1	R	5	Tx to Network
WAN 4-2	TI	26	Rx from Network
WAN 4-2	RI	1	Rx from Network
WAN 4-2	T	27	Tx to Network
WAN 4-2	R	2	Tx to Network
All other pins are open. Also WAN cards 1 through 4 are installed in slots W1 through W4, respectively, of all chassis models.			

C.2.3 INF Card (892460)

The INF card does not have a modem and does not accept external synchronization clocks. In all other respects, it is functionally identical to the INF-E and INF+M cards.

C.2.3.1 INF Card External Connector and Pinouts

Figure C-14 shows the INF card front panel, which has several jacks.

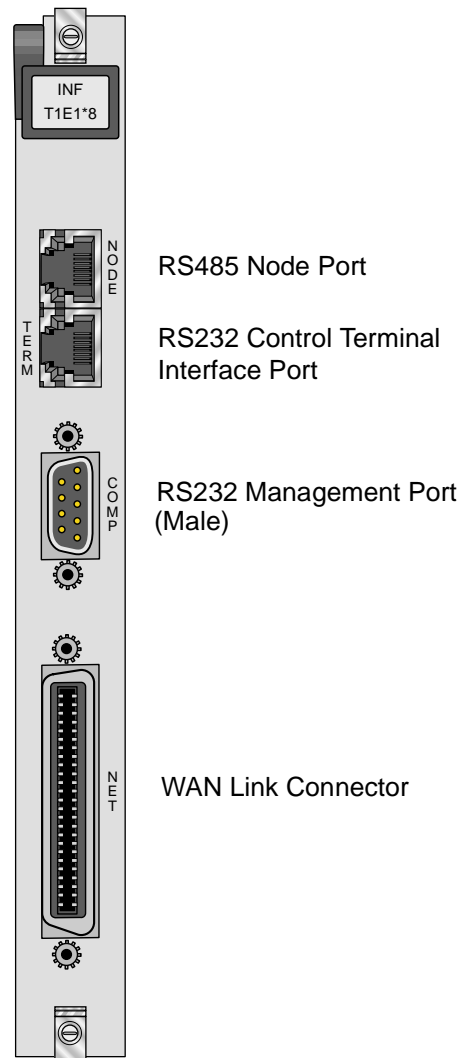

Figure C-14. 8924 Interface Card Jacks (892460)

The INF card uses faceplate connectors that are electrically similar to those of the INF-E and INF+M cards previously described. The only exception is that the NODE jack of the INF card serves two purposes. It provides alarm relay contacts for external activation, and also provides data and clock interfaces for external alarm reporting systems.

Connect the INF card to the external local terminal, alarm reporting system or printer, and T1/E1 network, as previously described for the other Interface cards. Also connect the alarm relay contacts and synchronization clocks to the NODE jack. Table C-12 lists the signal pinouts for that jack.

Using the RS-485 Node Port

The RS-485 Node port allows you to activate external alarms that alert on-site personnel to critical situations. Using the ACO function will keep the alarm active until it is manually cleared from a control terminal.

Connect the NODE jack of the INF card to the external alarm equipment. This is another RJ-48 jack; it provides a set of form-C relay contacts to the external alarm equipment. Figure C-15 shows the pin locations on this jack, which are the same as the COM2 jack. Table C-12 lists the associated signal pinouts.

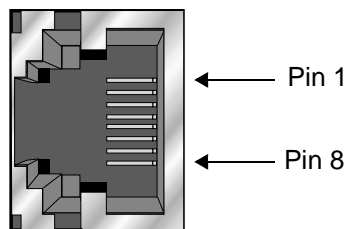

Figure C-15. RJ48 (NODE) Jack

Table C-12. RJ48 (NODE) Jack Signal Pinouts

RJ48 Pin	Designation	Function
1	---	not used
2	---	not used
3	ANC	Alarm on Closed Condition
4	ANO	Alarm on Open Condition
5	ACOM	Alarm Common Lead (Source)
6	---	not used
7	---	not used
8	GND	Chassis Ground

The alarm interface is activated by the ACO setting. This will activate the device when a designated alarm occurs. See chapter on Alarms to review the conditions and settings necessary to enable this feature.

Connect pins 4 and 5 to provide an open relay contact to the external device upon occurrence of an alarm. Or, connect pins 3 and 5 for a relay contact closure upon alarm.

Using the Control Terminal Port

The RS-232 Control Terminal Port allows you to connect the Integrated Access System to a local VT100-compatible terminal, which you can then use to control the system. This port is configured as a DCE interface.

Connect your local terminal to the TERM jack of the INF-E card. This is an RJ-48 jack in compliance with EIA-561. Figure C-16 shows the pin locations on this jack, and Table C-13 lists the signal pinouts.

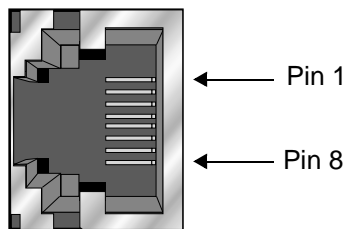

Figure C-16. RS232 (TERM) Local Interface Jack

Table C-13. RS232 (TERM) Jack Signal Pinouts

RS232 Pin	Function	Direction
4	Signal Ground	N/A
5	Receive Data	To local terminal
6	Transmit Data	To access system
All other pins are open.		

C.3 Alarm Cards

C.3.1 ALR 4+4 Card (8401840160)

C.3.1.1 ALR 4+4 Card External Connectors and Pinouts

The ALR 4+4 Card has a 50-pin Amphenol female connector (jack) on its faceplate. Figure C-17 shows the jack, and Table C-14 shows the pinouts for the inbound sensor alarms and outbound internal alarms.

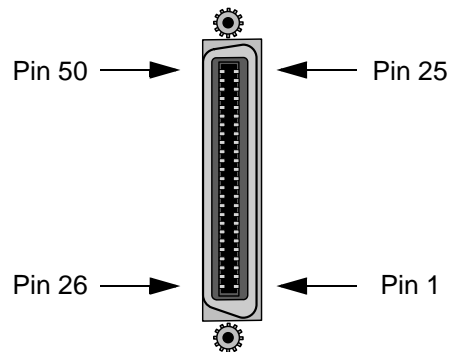

Figure C-17. ALR 4+4 Card Jack

Table C-14. ALR 4+4 Card Jack Pinouts

Inbound Alarms			Outbound Alarms			
Sensor	Designation	Pin	Relay	Source	Norm Close	Norm Open
1	R1	1	R1(A)	7	6	8
	T1	26	R1(B)	32	31	33
2	R2	2	R2(A)	11	10	12
	T2	27	R2(B)	36	35	37
3	R3	3	R3(A)	15	14	16
	T3	28	R3(B)	40	39	41
4	R4	4	R4(A)	19	18	20
	T4	29	R4(B)	44	43	45

C.3.2 ALR 4+3PF Card (8402608402)

C.3.2.1 ALR 4+3PF Card External Connectors and Pinouts

The ALR 4+3PF Card has a 50-pin Amphenol female connector (jack) on its faceplate. Figure C-17 shows the jack, and Table C-14 shows the pinouts for the inbound sensor alarms and outbound internal alarms.

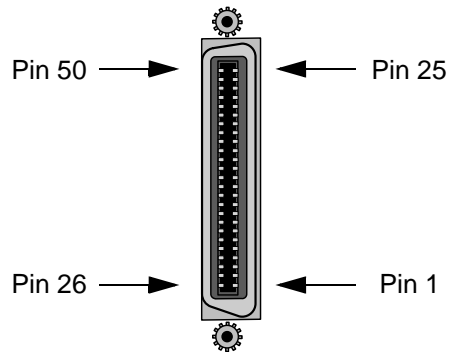

Figure C-18. ALR 4+3PF Card Jack

Table C-15. ALR 4+3PF Card Jack Pinouts

Inbound Alarms			Outbound Alarms			
Sensor	Designation	Pin	Relay	Source	Norm Close	Norm Open
1	R1	1	R1(A)	7	6	8
	T1	26	R1(B)	32	31	33
2	R2	2	R2(A)	11	10	12
	T2	27	R2(B)	36	35	37
3	R3	3	R3(A)	15	14	16
	T3	28	R3(B)	40	39	41
4	R4	4	R4(A)	19	18	20
	T4	29	R4(B)	44	43	45

C.3.3 ALR 28+14 Card (8403608403)

C.3.3.1 ALR 28+14 Card External Connectors and Pinouts

External Alarm Equipment Connections

The ALR 28+14 Card has two Amphenol jacks, labeled P1(lower) and P2 (upper). Use these to connect the card to the external alarm equipment. Figure C-19 shows these jacks, and Figure C-17 shows their pin orientations, which are the same as for the ALR 4+4 Card jack. The signal pinouts for the sensors are listed in Table C-16, and the pinouts for the switches are given in Table C-17.

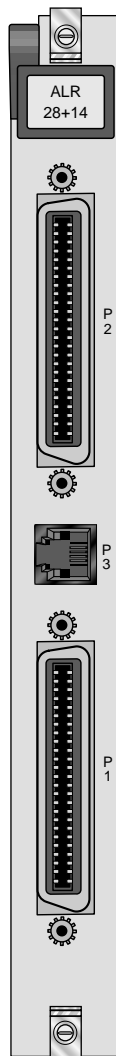

Figure C-19. ALR 28+14 Card Jacks (840360)

Table C-16. ALR 28+14 Card Alarm Sensor Pinouts

Sensor	Desig.	J3 Connector Pin
1	sense -	12
	sense +	37
2	sense -	13
	sense +	38
3	sense -	14
	sense +	39
4	sense -	15
	sense +	40
5	sense -	16
	sense +	41
6	sense -	17
	sense +	42
7	sense -	18
	sense +	43
8	sense -	19
	sense +	44
9	sense -	20
	sense +	45
10	sense -	21
	sense +	46
11	sense -	22
	sense +	47
12	sense -	23
	sense +	48
13	sense -	24
	sense +	49
14	sense -	25
	sense +	50

Sensor	Desig.	J4 Connector Pin
15	sense -	12
	sense +	37
16	sense -	13
	sense +	38
17	sense -	14
	sense +	39
18	sense -	15
	sense +	40
19	sense -	16
	sense +	41
20	sense -	17
	sense +	42
21	sense -	18
	sense +	43
22	sense -	19
	sense +	44
23	sense -	20
	sense +	45
24	sense -	21
	sense +	46
25	sense -	22
	sense +	47
26	sense -	23
	sense +	48
27	sense -	24
	sense +	49
28	sense -	25
	sense +	50

Table C-17. ALR 28+14 Card Alarm Switch Pinouts

Switch #	Contact Type Form	Desig.	J3 Connector Pin #	Switch #	Contact Type Form	Desig.	J4 Connector Pin #
1	C	Open	2	8	C	Open	27
		Close	1			Close	26
		Comm	3			Comm	28
2	C	Open	27	9	C	Open	2
		Close	26			Close	1
		Comm	28			Comm	3
3	A	Open	---	10	B	Open	4
		Close	4			Close	---
		Comm	29			Comm	29
4	C	Open	6	11	C	Open	6
		Close	5			Close	5
		Comm	7			Comm	7
5	C	Open	31	12	C	Open	31
		Close	30			Close	30
		Comm	32			Comm	32
6	C	Open	9	13	C	Open	9
		Close	8			Close	8
		Comm	10			Comm	10
7	C	Open	34	14	C	Open	34
		Close	33			Close	33
		Comm	35			Comm	35

Voice Circuit Connection

Between the Amphenol connectors is a standard RJ-11 connector for interfacing with a 2-wire, 600-ohm voice circuit. The pin positions for this connector are shown in Figure C-20, and its pinouts are given in Table C-18. The RJ-11 port can be used to send system alarms to a remote device.

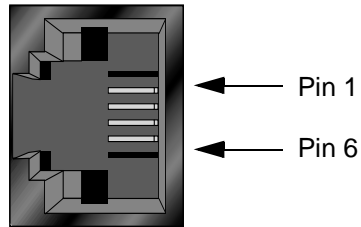

Figure C-20. RJ-11 Jack

Table C-18. RJ-11 Jack Signal Pinouts

Pin	Function
3	Ring
4	Tip
All other pins are open.	

C.4 HSU Cards

C.4.1 Two-Port HSU530/35 Card (820260)8202

C.4.1.1 Two-Port HSU Card External Connectors and Pinouts

The two-port HSU 530/35 Card has two DB-25 jacks for external connections, as shown in Figure C-21. The connectors have the following characteristics:

The card jacks are wired as RS-530 interfaces. Figure C-22 shows their pin locations, and Table C-19 lists the signal pinouts.

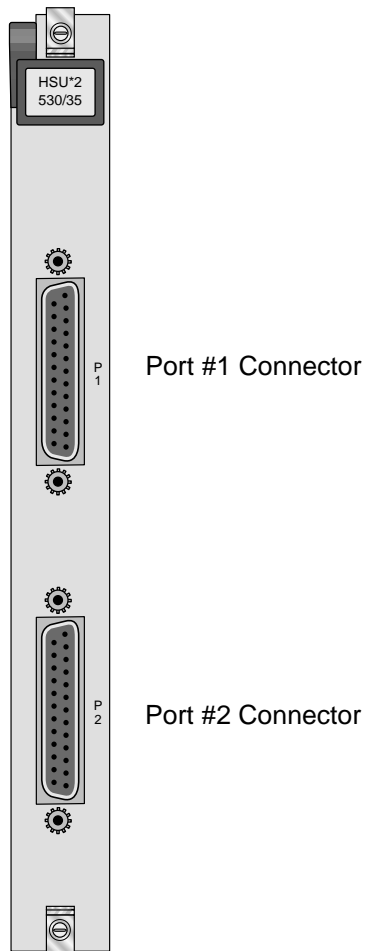

Figure C-21. Two-Port HSU 530/35 Front Panel Connectors (820260)

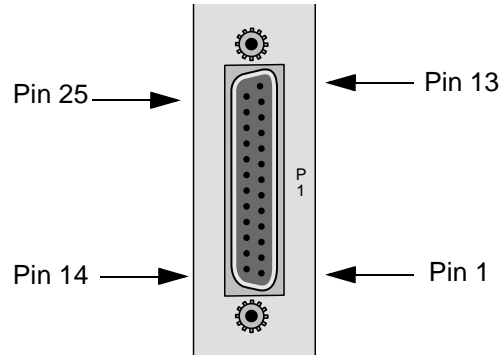

Figure C-22. Two-Port HSU 530/35 Jack Pin Orientation

Table C-19. Two-Port HSU 530/35 Jack Pinouts

Pin	Function	Direction
1	Cable Shield	--
2	Send Data A	Input
3	Receive Data A	Output
4	RTS A	Input
5	CTS A	Output
6	DCE Ready	Output
7	Signal Common	--
8	RR/RLSD A	Output
9	Receive Timing B	Output
10	RR/RLSD B	Output
11	Terminal Timing B	Input
12	Send Timing B	Output
13	CTS B	Output
14	Send Data B	Input
15	Send Timing A	Output
16	Receive Data B	Output
17	Receive Timing A	Output
18	Local Loopback	Input
19	RTS B	Input
20	DTE Ready	Input
21	Remote Loopback	Input
22	Incoming Call	Output
23	Receive Common	--
24	Terminal Timing A	Input
25	Test Mode	Output

C.4.2 HSU-T V11 Card (8203608203)

C.4.2.1 HSU-T V11 Card External Connectors and Pinouts

The HSU-T V11 Card has two DB-25 connectors, as shown in Figure C-23. The connector pin locations are shown in Figure C-21, and the jack signal pinouts are given in Table C-20.

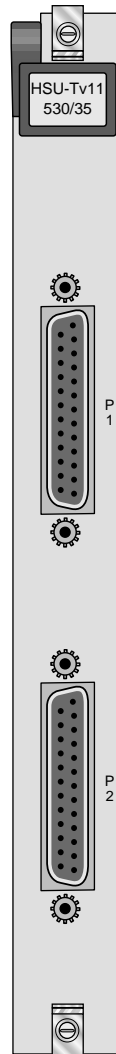

Figure C-23. HSU-T V11 Card Front Panel Connectors (820360)

Table C-20. HSU-T V11 Jack Pinouts

Pin	Function	DCE Mode	DTE Mode
1	Cable Shield	--	--
2	Send Data A	Input	Input
3	Receive Data A	Output	Output
4	RTS A	Input	Input
5	CTS A	Output	Input
6	DCE Ready	Output	Output
7	Signal Common	--	--
8	RR/RLSD A	Output	Output
9	Receive Timing B	Output	Input
10	RR/RLSD B	Output	Output
11	Terminal Timing B	Input	Input
12	Send Timing B	Output	Output
13	CTS B	Output	Input
14	Send Data B	Input	Input
15	Send Timing A	Output	Output
16	Receive Data B	Output	Input
17	Receive Timing A	Output	Output
18	Local Loopback	Input	Input
19	RTS B	Input	Input
20	DTE Ready	Input	Input
21	Remote Loopback	Input	Input
22	Incoming Call	Output	Output
23	Receive Common	--	--
24	Terminal Timing A	Input	Input
25	Test Mode	Output	

C.4.3 HSU 35 Card (8212821260)

C.4.3.1 HSU 35 Card External Connectors and Pinouts

The HSU 35 Card has two DB-25 jacks for V.35 connections to the external CPE. Figure C-24 shows these jacks, previous Figure C-24 shows their pin locations, and Table C-21 lists the signal pinouts.

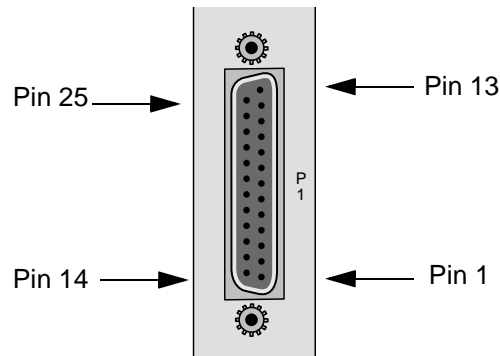

Figure C-24. HSU 35 Card Jack Pin Orientation

Table C-21. HSU 35 Card Jack Signal Pinouts

Pin	Function	DCE Mode	DTE Mode
1	Cable Shield	---	---
4	RTS	Input	Input
5	CTS	Output	Input
6	DSR	Output	Output
7	Signal Ground	---	---
8	RLSD	Output	Output
9	SD B	Input	Input
10	SD A	Input	Input
11	SCTE B	Input	Input
12	SCTE A	Input	Input
13	RD B	Output	Output
14	RD A	Output	Output
17	SCR B	Output	Input
18	SCR A	Output	Input
24	SCT B	Output	Output
25	SCT A	Output	Output

C.4.4 HSU-AD 530/35 Card (8213608213)

C.4.4.1 HSU-AD 530/35 Card External Connectors and Pinouts

The HSU-AD 530/35 Card has two DB-26 jacks for RS-530 or V.35 connections, plus two DB-15 female connectors for RS-366 dialing connections in an ISDN environment. Figure C-25 shows these jacks.

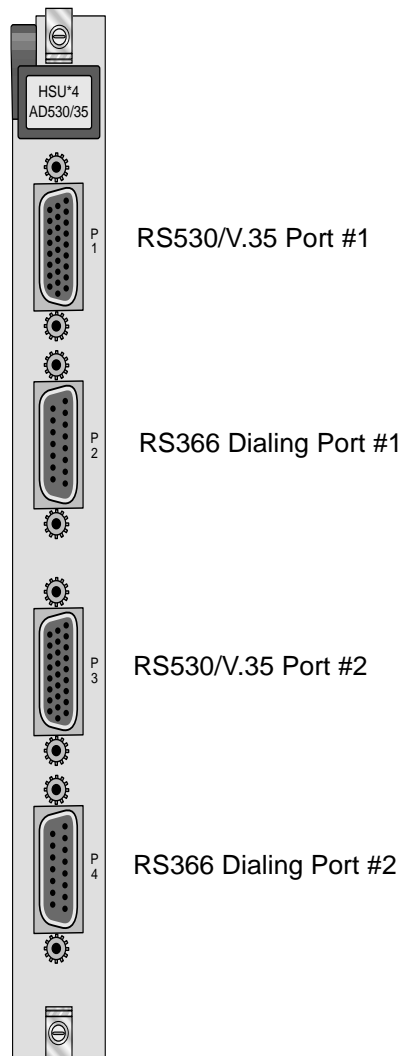

Figure C-25. HSU-AD 530/35 Card Jacks (821360)

RS530/V.35 Jacks

The RS-530/V.35 jacks allow you to connect the card to two external CPE devices. The electrical configuration of each jack is switch-selectable on the main board. Figure C-26 shows the jack pin locations, and Table C-22 lists the signal pinouts.

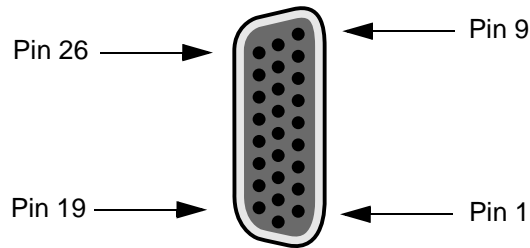

Figure C-26. HSU-AD 530/35 Card Jack Pin Orientation

Table C-22. HSU-AD 530/35 Card Jack Signal Pinouts

Pin #	Function	Direction
1	Cable Shield	--
2	Send Data A	Input
3	Receive Data A	Output
4	RTS A	Input
5	CTS A	Output
6	DCE Ready	Output
7	Signal Common	--
8	RR/RLSD A	Output
9	Receive Timing B	Output
10	RR/RLSD B	Output
11	Terminal Timing B	Input
12	Send Timing B	Output
13	CTS B	Output
14	Send Data B	Input
15	Send Timing A	Output
16	Receive Data B	Output
17	Receive Timing A	Output
18	Local Loopback	Input
19	RTS B	Input
20	DTE Ready	Input
21	Remote Loopback	Input
22	Incoming Call	Output
23	Ext Rcv Clock	Input
24	Terminal Timing A	Input
25	Test Mode	Output
26	Ext Rcv Clock	Input

RS-366 Jacks

The HSU-AD 530/35 Card RS-366 jacks allow you to connect the system to external CPE devices for RS-366 dialing. These are DB-15 jacks with the pin locations shown in Figure C-27. Table C-23 lists the signal pinouts.

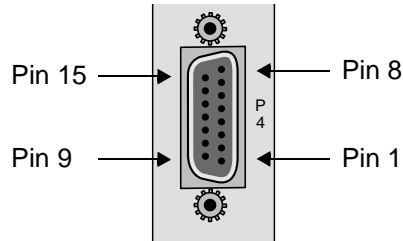

Figure C-27. HSU-AD 530/35 Card RS-366 Jack Pin Orientation

Table C-23. HSU-AD 530/35 Card RS-366 Jack Pinouts

Pin	Function	Direction
1	Cable Shield	--
2	DPR	Input
3	ACR	Output
4	CRQ	Input
5	PND	Output
6	PWI	Output
7	Signal Gnd	--
8	DSC	Output
9	NB1	Input
10	NB2	Input
11	NB4	Input
12	NB8	Input
13	REC COM	--
14	SEND COM	--
15	DLO	Output

C.4.5 HSU-T V35 Card (8214821460)

C.4.5.1 HSU-T V35 Card External Connectors and Pinouts

The HSU-T V35 Card has two DB-25 female connectors, which are shown in Figure C-28. Figure C-29 shows the connector pin locations, and Table C-24 lists the signal pinouts.

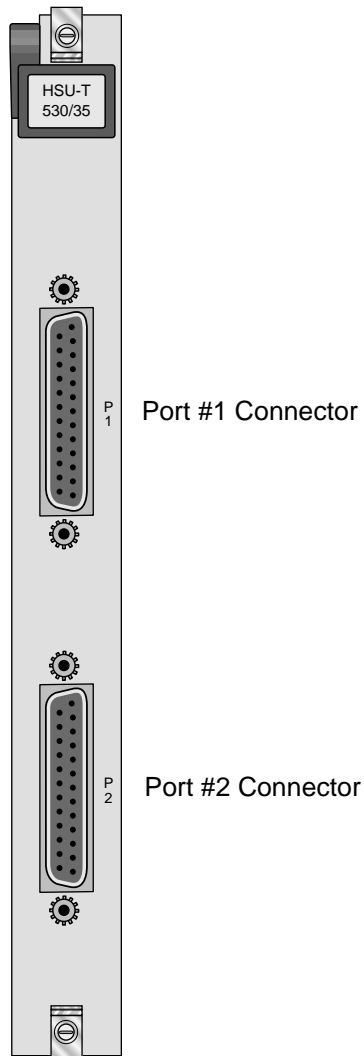

Figure C-28. HSU-T V35 Card Front Panel Connectors (821460)

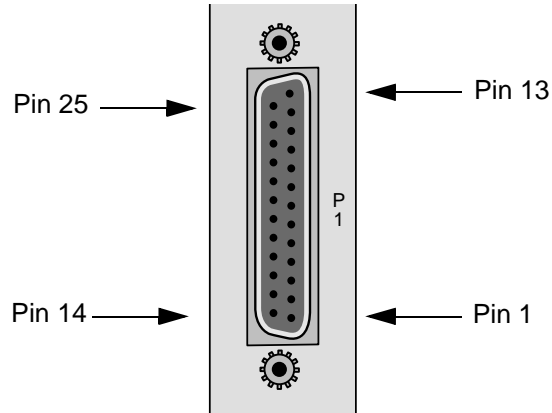

Figure C-29. HSU-T V35 Card Jack Pin Orientation

Table C-24. HSU-T V35 Card Jack Pinouts

Pin	MODE DCE ¹	MODE DTE ²
1	Shield Ground	Shield Ground
4	RTS	CTS
5	CTS	RTS
6	DSR	DTR
7	Signal Ground	Signal Ground
8	RR/RLSD	RLB
9	TD B	RD B
10	TD A	RD A
11	SCTE B	SCT B
12	SCTE A	SCT A
13	RD B	TD B
14	RD A	TD A
15	---	---
16	---	---
17	SCR B	---
18	SCR A	---
19	TM	LLB
20	DTR	DSR
21	RLB	RR/RLSD
22	LLB	TM
24	SCT B	SCTE B
25	SCT A	SCTE A

1. Use cable P/N 000-01260F if HSU-T V35 card is set to DCE mode.
2. Use cable P/N 000-01260M if HSU-T V35 card is set to DTE mode.

C.4.6 Four-Port HSU 530/35 Card (8215608215/821570)

C.4.6.1 Four-Port HSU 530/35 Card External Connectors and Pinouts

The four-port HSU 530/35 Card has four DB-26 female connectors, as shown in Figure C-30.

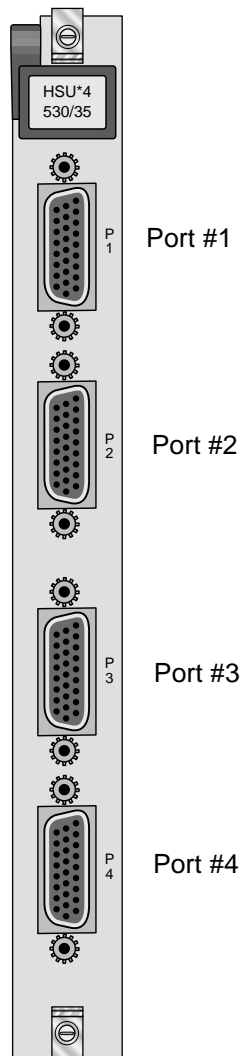

Figure C-30. Four-Port HSU 530/35 Card Jacks (821560)

The RS-530/V.35 connectors allow you to connect the system to external data devices. Figure C-26 shows the connector pin orientation, and Table C-25 lists the signal pinouts.

Table C-25. Four-Port HSU 530/35 Jack Pinouts

Pin	Function	Direction
1	Cable Shield	--
2	Send Data A	Input
3	Receive Data A	Output
4	RTS A	Input
5	CTS A	Output
6	DCE Ready	Output
7	Signal Common	--
8	RR/RLSD A	Output
9	Receive Timing B	Output
10	RR/RLSD B	Output
11	Terminal Timing B	Input
12	Send Timing B	Output
13	CTS B	Output
14	Send Data B	Input
15	Send Timing A	Output
16	Receive Data B	Output
17	Receive Timing A	Output
18	Local Loopback	Input
19	RTS B	Input
20	DTE Ready	Input
21	Remote Loopback	Input
22	Incoming Call	Output
23	Ext Rcv Clock	Input
24	Terminal Timing A	Input
25	Test Mode	Output
26	Ext Rcv Clock	Input

C.4.7 Four-Port HSU*4E 530/35 SS Card (821660)

C.4.7.1 External Connectors and Pinouts

The four-port HSU*4E 530/35 SS Card has four DB-26 female connectors, as shown in Figure C-31.

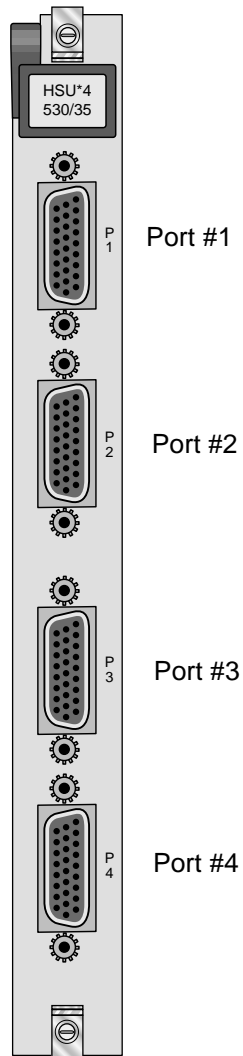

Figure C-31. Four-Port HSU*4E 530/35 SS Card Jacks (821660)

The RS-530/V.35 connectors allow you to connect the system to external data devices. Figure C-26 shows the connector pin orientation, and Table C-26 lists the signal pinouts.

Table C-26. Four-Port HSU*4E 530/35 SS Jack Pinouts

Pin	Function	Direction
1	Cable Shield	--
2	Send Data A	Input
3	Receive Data A	Output
4	RTS A	Input
5	CTS A	Output
6	DCE Ready	Output
7	Signal Common	--
8	RR/RLSD A	Output
9	Receive Timing B	Output
10	RR/RLSD B	Output
11	Terminal Timing B	Input
12	Send Timing B	Output
13	CTS B	Output
14	Send Data B	Input
15	Send Timing A	Output
16	Receive Data B	Output
17	Receive Timing A	Output
18	Local Loopback	Input
19	RTS B	Input
20	DTE Ready	Input
21	Remote Loopback	Input
22	Incoming Call	Output
23	Ext Rcv Clock	Input
24	Terminal Timing A	Input
25	Test Mode	Output
26	Ext Rcv Clock	Input

C.4.8 HSU Card Cables

Table C-27, Table C-28, and Table C-29 represent a matrix used for connecting cables to HSU Cards for DTE and DCE transmit clocking. The following HSU Cards apply (820260, 820360, 821260, 821360, 821460, 821560 and 821660).

Table C-27. HSU to Cable Matrix (To DTE Clock)

HSU CARD	TO A DTE THAT ACCEPTS CLOCK				
	RS232	RS366	RS449	RS530	V.35
820260 NO SWITCHES	1252/1221*		1212F/M	1204F/M	1203F/1251
820260 WITH SWITCHES	1252/1221*		1212F/M	1204F/M	1261F/M
820360 DCE	1252/1221*		1212F/M	1204F/M	1261F/M
820360 DTE					
821260					1203F/M
821360/821560/821660	1264F/1253**	1206F	1265F/M	1264F/M	1263F/M
821460 DCE					1260F/M
821460 DTE					
2 PORT EXT. CABLES	1221			1222	1224
4 PORT EXT. CABLES				1269	1268

*820260/820360 Switches set to RS-530 and 1252 Connected to HSU Card

**The 1253 Connects to the end of the 1264F Cable

Table C-28. HSU to Cable Matrix (To DCE Clock)

HSU CARD	TO A DCE THAT ACCEPTS CLOCK		
	RS449	RS530	V.35
820260 NO SWITCHES	1212X	1204X	1203X/1251
820260 WITH SWITCHES	1212X	1204X	1261X
820360 DCE	1212X	1204X	1261X
820360 DTE			
821260			1203X
821360/821560/821660	1265X	1264X	1263X
821460 DCE			1203X
821460 DTE			
2 PORT EXT. CABLES		1222	1224
4 PORT EXT. CABLES		1269	1268

Table C-29. HSU to Cable Matrix (DCE Provides Clock)

HSU CARD	DCE PROVIDES CLOCK		
	RS530	V.35	RS449
820260 NO SWITCHES			
820260 WITH SWITCHES			
820360 DCE			
820360 DTE	1204X		1211
821260			
821360/821560/821660			
821460 DCE			
821460 DTE		1260F/M	
2 PORT EXT. CABLES			
4 PORT EXT. CABLES			

C.5 SRU Cards

C.5.1 SRU 232*10 Card (8220608220)

C.5.1.1 SRU 232*10 Card External Connector and Pinouts

The SRU 232*10 Card has ten modular jacks on its faceplate for connections to the external data devices. Figure C-32 shows these jacks, and Table C-30 lists the signal pinouts.

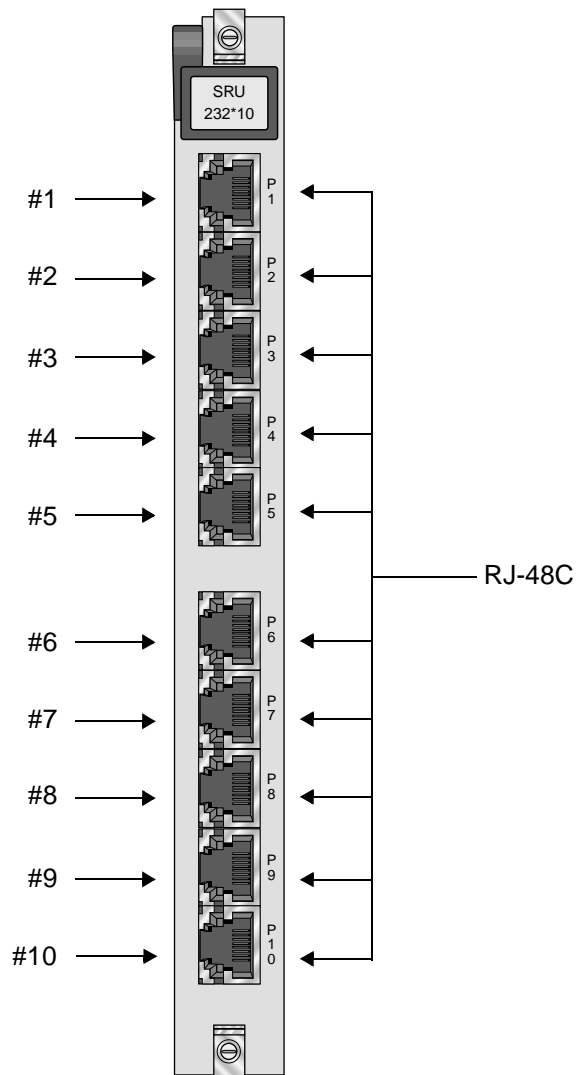

Figure C-32. SRU 232*10 Card Jacks (822060)

Table C-30. SRU 232*10 Card Jack Pinouts

Connector Pin	Signal Name	Direction
1	RCLK	To DTE
2	RLSD	To DTE
3	TCLK	To DTE
4	GND	N/A
5	RD	To DTE
6	TD	From DTE
7	CTS	To DTE
8	RTS	From DTE

C.5.2 SRU 232*10 C&D Bus Card (8221608220)

C.5.2.1 SRU 232*10 C&D Bus Card External Connector and Pinouts

The SRU 232*10 C&D Bus Card has ten modular jacks on its faceplate for connections to the external data devices. Figure C-32 shows these jacks, and Table C-30 lists the signal pinouts.

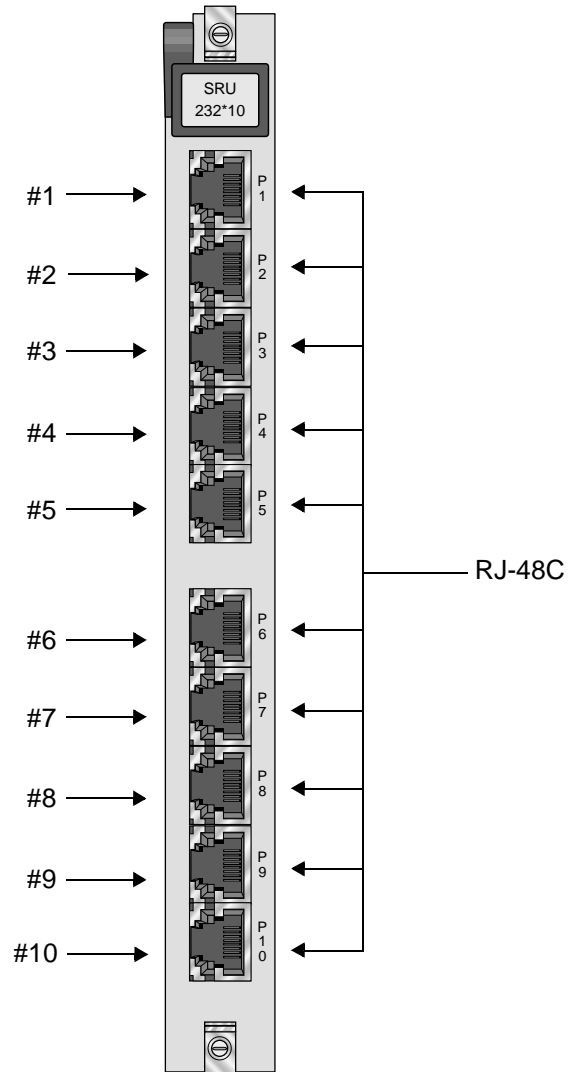

Figure C-33. SRU 232*10 C&D Bus Card Jacks (822160)

Table C-31. SRU 232*10 C&D Bus Card Jack Pinouts

Connector Pin	Signal Name	Direction
1	RCLK	To DTE
2	RLSD	To DTE
3	TCLK	To DTE
4	GND	N/A
5	RD	To DTE
6	TD	From DTE
7	CTS	To DTE
8	RTS	From DTE

C.6 OCU-DP Cards

C.6.1 OCU-DP 2 Card (82498249)

C.6.1.1 OCU-DP 2 Card External Connectors and Pinouts

Install the OCU-DP 2 Card into any of the same slots as the OCU-DP 5 Card. The OCU-DP 2 Card has two modular RJ-48 jacks. Figure C-34 shows these jacks, and Table C-32 lists the signal pinouts for each jack.

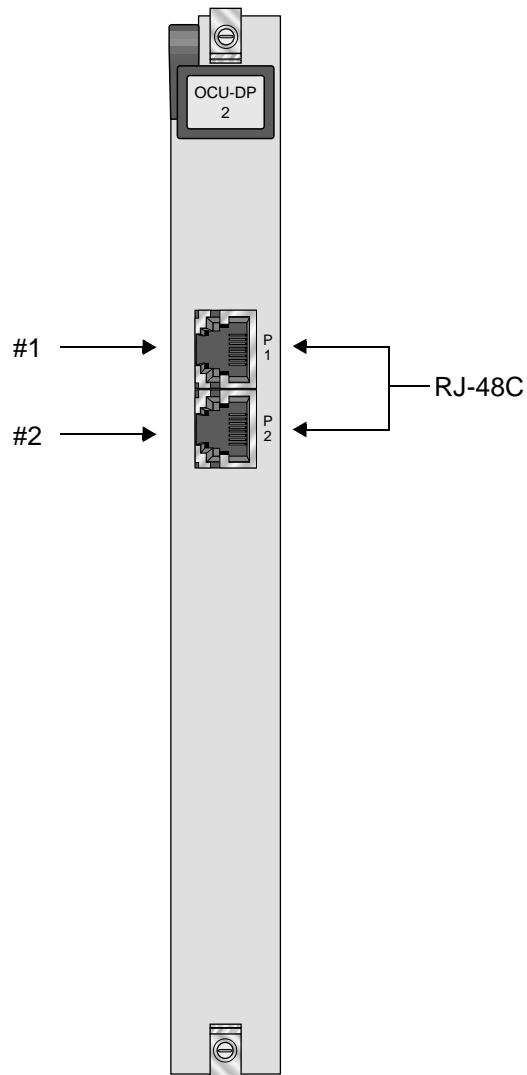

Figure C-34. OCU-DP 2 Card Jacks

Table C-32. OCU-DP 2 Jack Signals Pinouts

RJ-48 Pin	Signal Name	Direction
1	R1	input
2	T1	input
3	--	--
4	--	--
5	--	--
6	--	--
7	T	output
8	R	output

C.6.2 OCU-DP 5 Card (8241824160)

C.6.2.1 OCU-DP 5 Card External Connectors and Pinouts

The OCU-DP 5 Card has five standard modular jacks. Figure C-35 shows the card jacks, and Table C-33 lists the signal pinouts for each jack.

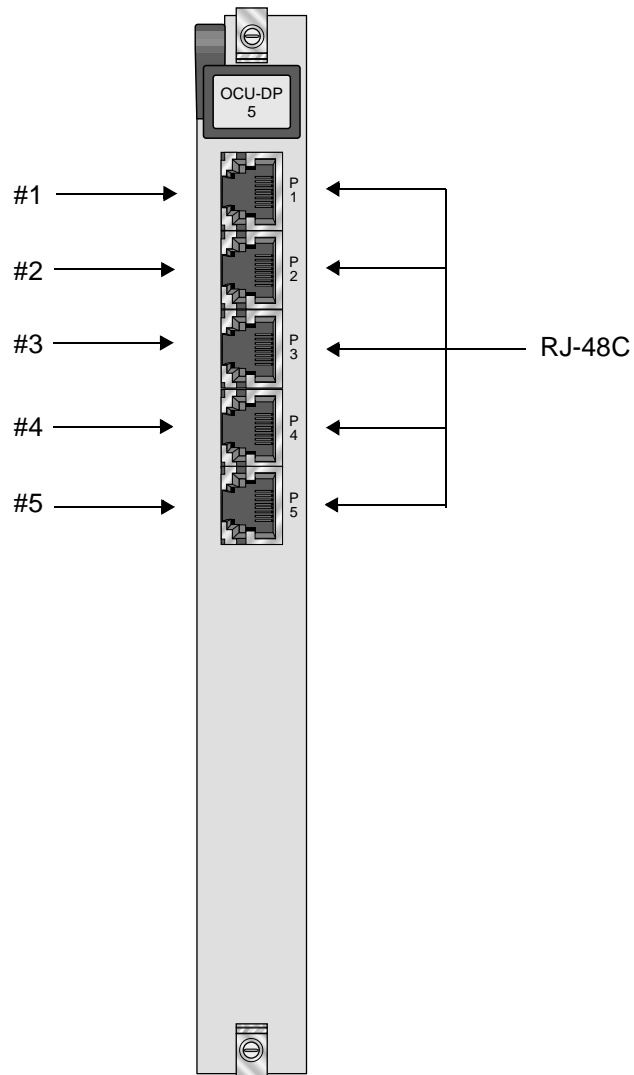

Figure C-35. OCU-DP 5 Card Jacks (842160)

Table C-33. OCU-DP 5 Jack Signals Pinouts

RJ-48 Pin	Signal Name	Direction
1	R1	input
2	T1	input
3	--	--
4	--	--
5	--	--
6	--	--
7	T	output
8	R	output

C.6.3 OCU-DP 10 Card (8246608246)

C.6.3.1 OCU-DP 10 Card External Connectors and Pinouts

Figure C-36 shows the 10 RJ-48C jacks, and Table C-34 lists the signal pinouts for each jack.

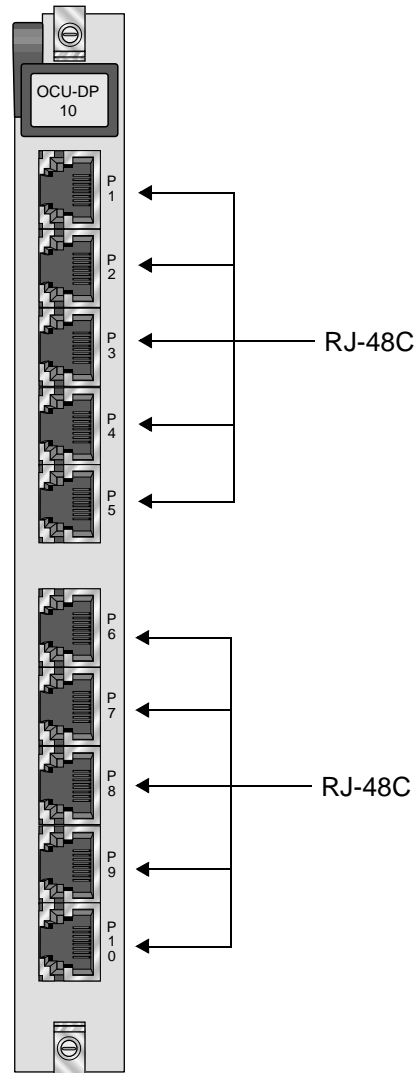

Figure C-36. OCU-DP 10 Card Jacks (824660)

Table C-34. OCU-DP 10 Jack Signals Pinouts

RJ-48 Pin	Signal Name	Direction
1	R1	input
2	T1	input
3	--	--
4	--	--
5	--	--
6	--	--
7	T	output
8	R	output

C.7 FRAD Cards

C.7.1 FRAD 232*10 Card (8231608231)

C.7.1.1 FRAD 232*10 Card External Connectors and Pinouts

The FRAD 232*10 Card has ten modular jacks that correspond to the 10 user ports assignable on each card. Figure C-37 depicts the card jacks, and Table C-35 lists the signal pinouts for these jacks.

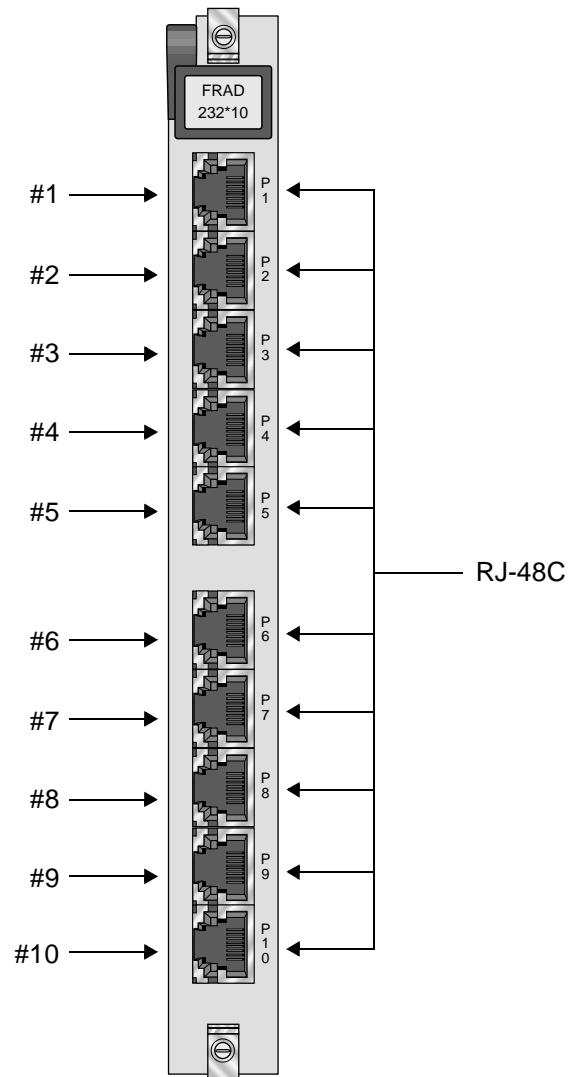

Figure C-37. FRAD 232*10 Card Jacks (823160)

Table C-35. FRAD 232*10 Card Jack Signal Pinouts

Male RJ-48 Pin	Signal Name	Direction
1	RCLK	output
2	RLSD	output
3	TCLK	output
4	GND	-
5	RD	output
6	TD	input
7	CTS	output
8	RTS	input

C.8 DS0-DP Cards

C.8.1 DS0-DP 4 Card (8254825460)

C.8.1.1 DS0-DP 4 Card External Connector and Pinouts

The DS0-DP 4 Card has four standard DB-15 jacks that correspond to the four data ports assignable on each card. Figure C-38 shows the card jacks and Table C-36 lists the signal pinouts for these jacks.

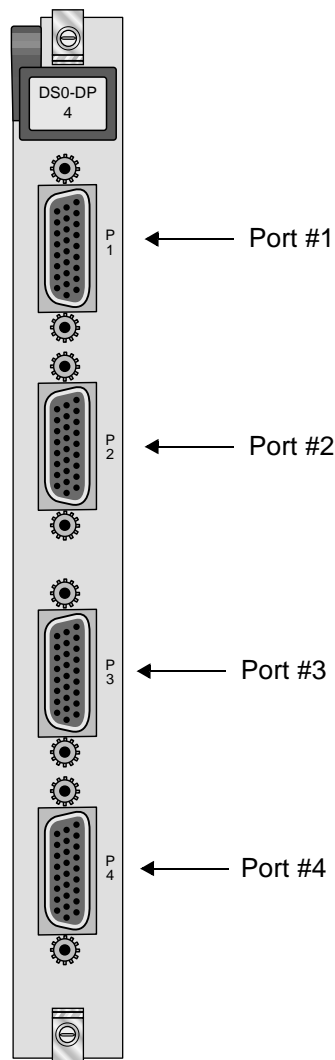

Figure C-38. DS0-DP 4 Card Jacks (825460)

Table C-36. DS0-DP 4 Card Jack Pinouts

Pin	Description	CLK	Direction	Mode
1	GND	---	---	
2	N/C	---	---	
3	XMT CLK A	int	To DTE	G.703 Contradirectional
4	RCV CLK A	int	To DTE	G.703 Contradirectional
5	XMT DAT A	int	To DTE	DS0-DP/G.703
6	RCV DAT A	int	From DTE	DS0-DP/G.703
7	BYTE CLK A	int/ext	To/From DTE	DS0-DP
8	BIT CLK A	int/ext	To/From DTE	DS0-DP
9	N/C	---	---	
10	XMT CLK B	int	To DTE	G.703 Contradirectional
11	RCV CLK B	int	To DTE	G.703 Contradirectional
12	XMT DAT B	int	To DTE	DS0-DP/G.703
13	RCV DAT B	int	From DTE	DS0-DP/G.703
14	BYTE CLK B	int/ext	To/From DTE	DS0-DP
15	BIT CLK B	int/ext	To/From DTE	DS0-DP

C.9 B7R Cards

C.9.1 B7R Card (822860)

C.9.1.1 B7R Card External Connector and Pinouts

The B7R card has ten modular jacks. The last two jacks (9 and 10) are for the Aggregate Port and Debug Port, respectively. Figure C-39 shows the card jacks, and Table C-37 lists the signal pinouts for these jacks.

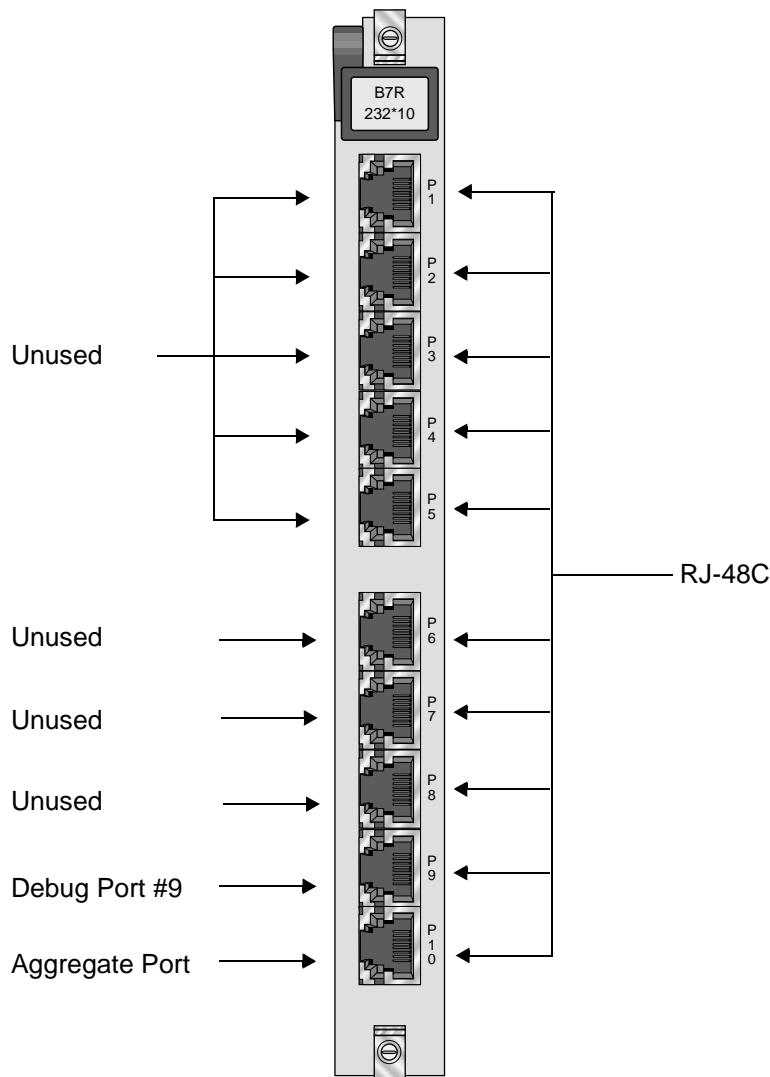

Figure C-39. B7R Card Jacks (822860)

Table C-37. B7R Card Jack Signal Pinouts

Male RJ-48 Pin #	Signal Name	Direction
1	* RCLK	output
2	RLSD	output
3	* TCLK	output
4	GND	-
5	RD	output
6	TD	input
7	CTS	output
8	RTS	input
* Clocking is not necessary for Asynchronous Transmission		

C.10 BRI Cards

C.10.1 BRI U*8 Card (8260826070)

C.10.1.1 BRI U*8 Card External Connectors and Pinouts

The BRI U*8 Card has a 50-pin, Amphenol-type jack on its front panel for connection to external customer equipment. Figure C-40 shows the jack orientation, and Table C-38 gives the signal pinouts for this jack.

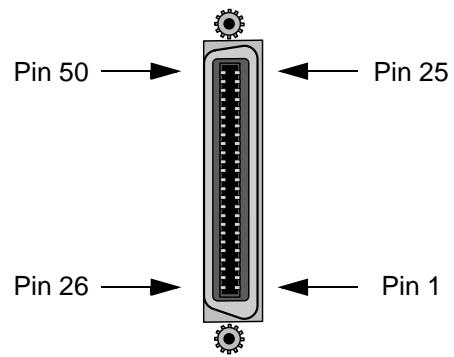

Figure C-40. BRI U*8 Card Jack

Table C-38. BRI U*8 Card Jack Signal Pinouts

Port #	Designation	Pin #
1	T1	26
1	R1	1
2	T2	29
2	R2	4
3	T3	32
3	R3	7
4	T4	35
4	R4	10
5	T5	38
5	R5	13
6	T6	41
6	R6	16
7	T7	44
7	R7	19
8	T8	47
8	R8	22
All other pins are open.		

C.10.2 BRI-SC U*8 Card (826171)

C.10.2.1 BRI-SC U*8 Card External Connectors and Pinouts

The BRI-SC U*8 Card has a 50-pin, Amphenol-type jack on its front panel for connection to external customer equipment. Figure C-41 shows the jack orientation, and Table C-39 gives the signal pinouts for this jack.

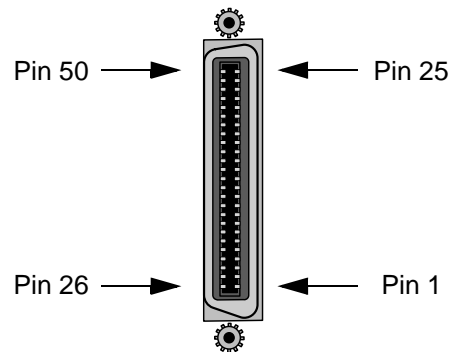

Figure C-41. BRI-SC U*8 Card Jack

Table C-39. BRI-SC U*8 Card Sealing Current Card Jack Signal Pinouts

Port #	Designation	Pin #
1	T1	26
1	R1	1
2	T2	29
2	R2	4
3	T3	32
3	R3	7
4	T4	35
4	R4	10
5	T5	38
5	R5	13
6	T6	41
6	R6	16
7	T7	44
7	R7	19
8	T8	47
8	R8	22
All other pins are open.		

C.10.3 BRI-ST*8 Card (8262826270)

C.10.3.1 BRI-ST*8 Card External Connectors and Pinouts

The BRI-ST*8 Card has a 50-pin, Amphenol-type jack on its front panel for connection to external customer equipment. Figure C-42 shows the current card jack, and Table C-40 gives the signal pinouts for this jack.

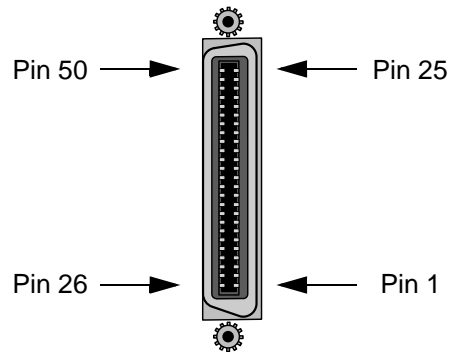

Figure C-42. BRI-ST*8 Card Jack

Table C-40. BRI-ST*8 Card Jack Signal Pinouts

Port	Designation	Pin #
1	Xmt-T0	26
1	Xmt-R0	1
1	Rcv-T0	27
1	Rcv-R0	2
2	Xmt-T1	29
2	Xmt-R1	4
2	Rcv-T1	30
2	Rcv-R1	5
3	Xmt-T2	32
3	Xmt-R2	7
3	Rcv-T2	33
3	Rcv-R2	8
4	Xmt-T3	35
4	Xmt-R3	10
4	Rcv-T3	36
4	Rcv-R3	11
5	Xmt-T4	38
5	Xmt-R4	13
5	Rcv-T4	39
5	Rcv-R4	14
6	Xmt-T5	41
6	Xmt-R5	16
6	Rcv-T5	42
6	Rcv-R5	17
7	Xmt-T6	44
7	Xmt-R6	19
7	Rcv-T6	45
7	Rcv-R6	20
8	Xmt-T7	47
8	Xmt-R7	22
8	Rcv-T7	48
8	Rcv-R7	23
External Power	+48v	50
External Power	-48v	25

C.10.4 PM-IOR Card (828060)

C.10.4.1 PM-IOR Card External Connectors and Pinouts

The PM-IOR Card has two RJ-48 form factor jacks on its front panel. Figure C-43 shows the PM-IOR card front panel displaying two RJ-48 form factor connectors. The “CO” is used to connect to a terminal/PC and the “Ethernet” is used to connect to the LAN for routing capabilities. Table C-41 lists the signal pinouts for the “CO” jack and Table C-42 lists the signal pinouts for the Ethernet jack.

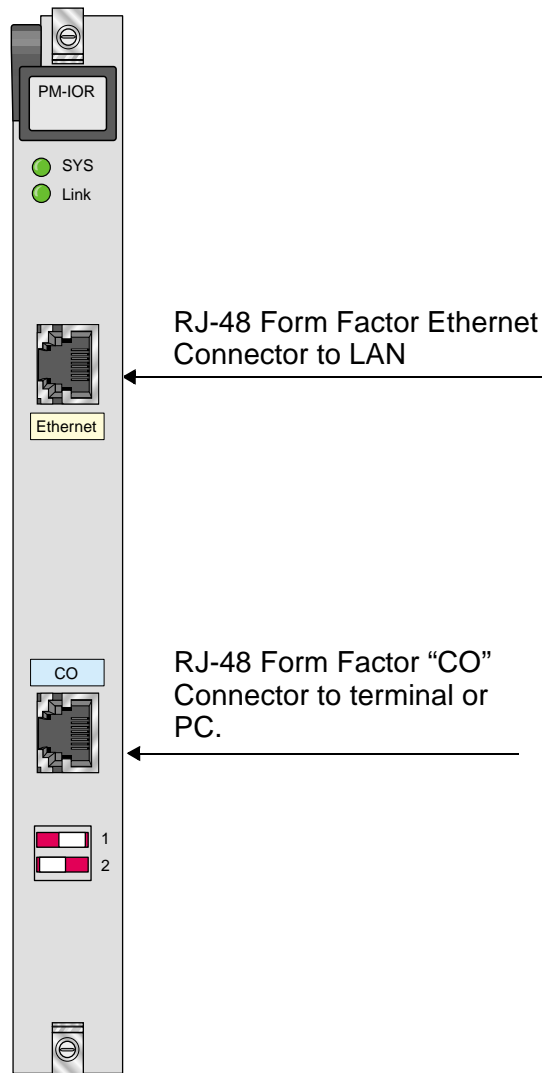

Figure C-43. RJ-48 Form Factor Card Jacks (828060)

Table C-41. PM-IOR Card Console Port “CO” Jack Pinouts

PM-IOR Card				PC or Terminal Serial Port	
RJ-48 Form Factor	Name	Definition	Direction	DB-25 (DTE)	Name
1	RTS	Request to Send	Output	5	CTS
2	DTR	Data Terminal Ready	Output	8 ¹	DCD
3	TXD	Transmit Data	Output	3	RXD
4	GND	Signal Ground		NC	
5	GND	Signal Ground		7	GND
6	RXD	Receive Data	Input	2	TXD
7	DCD	Data Carrier Detect	Input	20	DTR
8	CTS	Clear to Send	Input	4	RTS
NC ²		Data Set Ready		6 ¹	DSR

1. Pins 8 and 6 in the DB-25 connectors are connected internally.

2. Not connected.

Table C-42. PM-IOR Card Ethernet Port Jack Pinouts

RJ-48 Form Factor	Name	Definition	Direction
3	TXD	Transmit Data	Output
6	TXD-	Transmit Data	Output
4	RXD	Receive Data	Input
5	RXD-	Receive Data	Input

C.11 Server Cards

C.11.1 ACS-MCC Server Card (881360)

C.11.1.1 ACS-MCC External Connectors and Pinouts

The ACS-MCC card has an Ethernet interface port and uses a modular jack for a 10Base-T connection. Figure C-44 shows this jack, and Table C-43 lists the pinouts for this jack.

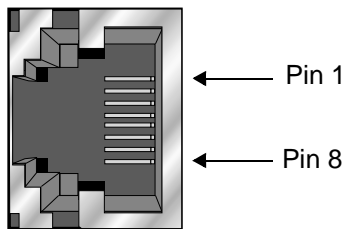

Figure C-44. ACS-MCC Card Ethernet Port Jack

Table C-43. ACS-MCC Card Ethernet Jack Pinouts

Pin	Function	Designation
1	Transmit (+)	X+
2	Transmit (-)	X-
3	Receive (+)	R+
6	Receive (-)	R-
All other pins are open.		

C.11.2 ACS-ATM Card (882060)

C.11.2.1 Card External Connectors and Signal Pinouts

The ATM Card connects to the LAN via a single Ethernet interface port in the form of a 10BASE-T RJ45 connector, shown in Figure C-45. The pin assignments for this port are shown in Table C-44.

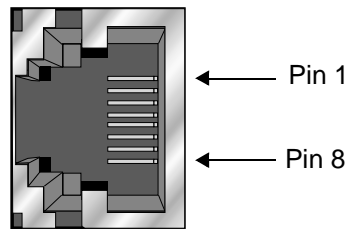

Figure C-45. ATM LAN Interface Connector Pin Assignment.

Table C-44. ATM LAN Interface Port Pin Assignment

Pin	Function	Designation
1	Transmit	X+
2	Transmit	X-
3	Receive	R+
6	Receive	R-
All other pins are open.		

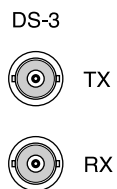

Figure C-46. DS3 connector

C.11.3 ACS-PRI/BRI Card (881162)

C.11.3.1 ACS-PRI/BRI Card External Connectors and Pinouts

The ACS-PRI/BRI card has an Ethernet interface port and uses a modular jack for a 10Base-T connection. Figure C-47 shows this jack, and Table C-45 lists the pinouts for this jack.

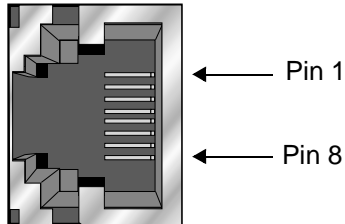

Figure C-47. ACS-PRI/BRI Card Ethernet Port Jack

Table C-45. ACS-PRI/BRI Card Ethernet Jack Pinouts

Pin	Function	Designation
1	Transmit (+)	X+
2	Transmit (-)	X-
3	Receive (+)	R+
6	Receive (-)	R-
All other pins are open.		

C.11.4 IPR 10BT Card (883160)

C.11.4.1 IPR 10BT Card External Connectors and Pinouts

The IPR 10BT card has an Ethernet interface port and uses a modular jack for a 10Base-T connection. Figure C-48 shows this jack, and Table C-46 lists the pinouts for this jack.

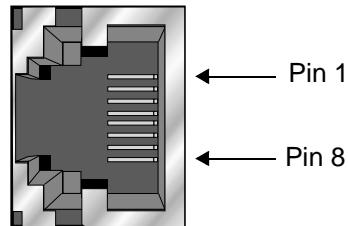

Figure C-48. IPR 10BT Card Ethernet Port Jack

Table C-46. IPR 10BT Card Ethernet Jack Pinouts

Pin	Function	Designation
1	Transmit (+)	X+
2	Transmit (-)	X-
3	Receive (+)	R+
6	Receive (-)	R-
All other pins are open.		

C.12 E&M Cards

C.12.1 E&M 2W*8 Card (8108608108)

C.12.1.1 E&M 2W*8 Card External Connectors and Pinouts

The card has a 50-pin, Amphenol-type jack on its faceplate. Figure C-49 shows this jack, and Table C-47 lists the signal pinouts.

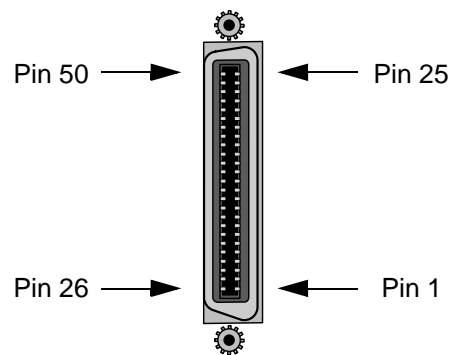

Figure C-49. E&M 2W*8 Card Jack

Table C-47. E&M 2W*8 Card Jack Pinouts

Port	Designation	Pin	Port	Designation	Pin
1	T	26	5	R	13
1	R	1	5	T1	39
1	T1	27	5	R1	14
1	R1	2	5	E	40
1	E	28	5	M	15
1	M	3	6	T	41
2	T	29	6	R	16
2	R	4	6	T1	42
2	T1	30	6	R1	17
2	R1	5	6	E	43
2	E	31	6	M	18
2	M	6	7	T	44
3	T	32	7	R	19
3	R	7	7	T1	45
3	T1	33	7	R1	20
3	R1	8	7	E	46
3	E	34	7	M	21
3	M	9	8	T	47
4	T	35	8	R	22
4	R	10	8	T1	48
4	T1	36	8	R1	23
4	R1	11	8	E	49
4	E	37	8	M	24
4	M	12	All channels	SG	25
5	T	38	All channels	SB	50

C.12.2 E&M 4W*8ER Card (8119811960)

C.12.2.1 E&M 4W*8ER Card External Connectors and Pinouts

The card has a 50-pin, Amphenol-type jack on its faceplate. Figure C-50 shows this jack, and Table C-48 lists the signal pinouts.

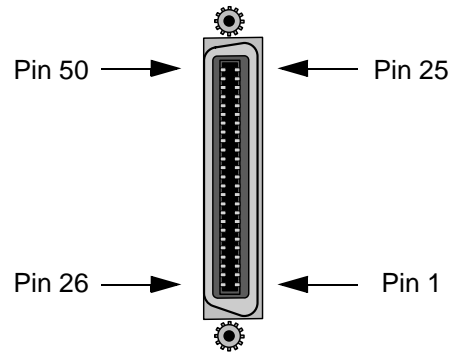

Figure C-50. E&M 4W*8ER Card Jack

Table C-48. E&M 4W*8ER Card Jack Pinouts

Port	Designation	Pin	Port	Designation	Pin
1	T	26	5	R	13
1	R	1	5	T1	39
1	T1	27	5	R1	14
1	R1	2	5	E	40
1	E	28	5	M	15
1	M	3	6	T	41
2	T	29	6	R	16
2	R	4	6	T1	42
2	T1	30	6	R1	17
2	R1	5	6	E	43
2	E	31	6	M	18
2	M	6	7	T	44
3	T	32	7	R	19
3	R	7	7	T1	45
3	T1	33	7	R1	20
3	R1	8	7	E	46
3	E	34	7	M	21
3	M	9	8	T	47
4	T	35	8	R	22
4	R	10	8	T1	48
4	T1	36	8	R1	23
4	R1	11	8	E	49
4	E	37	8	M	24
4	M	12	All channels	SG	25
5	T	38	All channels	SB	50

C.12.3 E&M 4W*8-2713Hz Card (8117608117)

C.12.3.1 E&M 4W*8-2713Hz Card External Connectors and Pinouts

The card has a 50-pin, Amphenol-type jack on its faceplate. Figure C-51 shows this jack, and Table C-49 lists the signal pinouts.

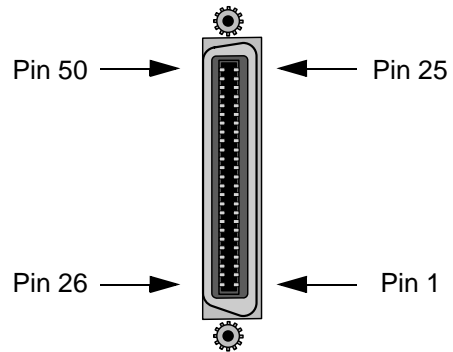

Figure C-51. E&M 4W*8-2713Hz Card Jack

Table C-49. E&M 4W*8-2713Hz Card Jack Pinouts

Port	Designation	Pin	Port	Designation	Pin
1	T	26	5	R	13
1	R	1	5	T1	39
1	T1	27	5	R1	14
1	R1	2	5	E	40
1	E	28	5	M	15
1	M	3	6	T	41
2	T	29	6	R	16
2	R	4	6	T1	42
2	T1	30	6	R1	17
2	R1	5	6	E	43
2	E	31	6	M	18
2	M	6	7	T	44
3	T	32	7	R	19
3	R	7	7	T1	45
3	T1	33	7	R1	20
3	R1	8	7	E	46
3	E	34	7	M	21
3	M	9	8	T	47
4	T	35	8	R	22
4	R	10	8	T1	48
4	T1	36	8	R1	23
4	R1	11	8	E	49
4	E	37	8	M	24
4	M	12	All channels	SG	25
5	T	38	All channels	SB	50

C.13 FXS Cards

C.13.1 FXS 2W*4-6 Card (81258125)

C.13.1.1 FXS 2W*4-6 Card External Connectors and Pinouts

The FXS 2W*4-6 Card has a 50-pin Amphenol jack located on its faceplate. Figure C-52 shows this jack, and Table C-50 lists the signal pinouts.

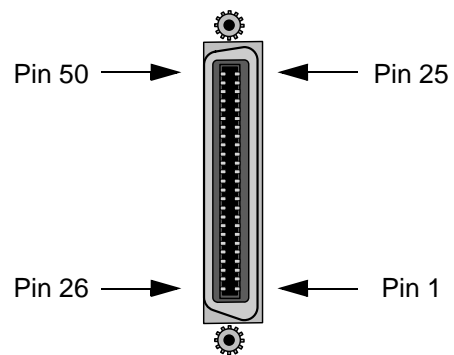

Figure C-52. FXS 2W*4-6 Card Jack

Table C-50. FXS 2W*4-6 Card Jack Pinouts

Port	Designation	Pin
1	T1	26
1	R1	1
2	T2	29
2	R2	4
3	T3	32
3	R3	7
4	T4	35
4	R4	10
All other pins are open.		

C.13.2 FXS 2W*8-6 Card (8129821960)

C.13.2.1 FXS 2W*8-6 Card External Connectors and Pinouts

The FXS 2W*8-6 Card has a 50-pin Amphenol jack on its faceplate. Figure C-52 shows this jack, and Table C-51 lists the signal pinouts.

Table C-51. FXS 2W*8-6 Card Jack Pinouts

Port #	Designation	Pin #
1	T1	26
1	R1	1
2	T2	29
2	R2	4
3	T3	32
3	R3	7
4	T4	35
4	R4	10
5	T5	38
5	R5	13
6	T6	41
6	R6	16
7	T7	44
7	R7	19
8	T8	47
8	R8	22
All other pins are open.		

C.14 FXO Cards

C.14.1 FXO 2W*8-6 Card (8139813960/813970)

C.14.1.1 FXO 2W*8-6 Card External Connector and Pinouts

The FXO 2W*8-6 card has a 50-pin Amphenol jack on its faceplate. Figure C-53 shows this jack, and Table C-52 lists the signal pinouts.

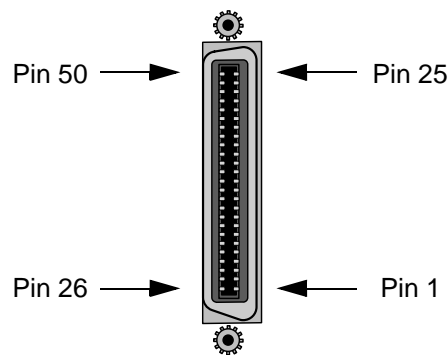

Figure C-53. FXO 2W*8-6 Card Jack

Table C-52. FXO 2W*8-6 Card Jack Pinouts

Port #	Designation	Pin #
1	T1	26
1	R1	1
2	T2	29
2	R2	4
3	T3	32
3	R3	7
4	T4	35
4	R4	10
5	T5	38
5	R5	13
6	T6	41
6	R6	16
7	T7	44
7	R7	19
8	T8	47
8	R8	22
All other pins are open.		

C.14.2 FXS Coin Card (814960)

C.14.2.1 Card External Connectors and Pinouts

The FXS Coin Card has a 50-pin Amphenol jack located on its faceplate. Figure C-54 shows this jack, and Table C-53 list the signal pinouts.

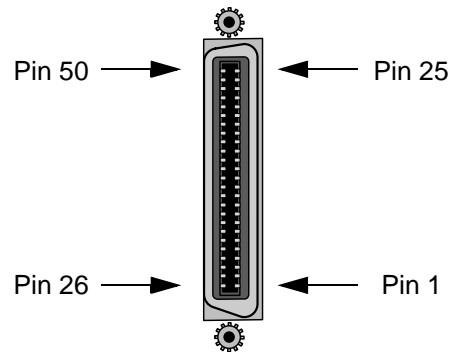

Figure C-54. FXS Coin Card Jack

Table C-53. FXS Coin Card Jack Pinouts

Port	Designation	Pin
1	T1	26
1	R1	1
2	T2	29
2	R2	4
3	T3	32
3	R3	7
4	T4	35
4	R4	10
5	R5	13
5	T5	38
6	R6	16
6	T6	41
All other pins are open.		

C.14.3 FXO Coin Card (815960)

C.14.3.1 Card External Connector and Pinouts

The FXO Coin Card has a 50-pin Amphenol jack on its faceplate. Figure C-55 shows this jack, and Table C-54 lists the signal pinouts.

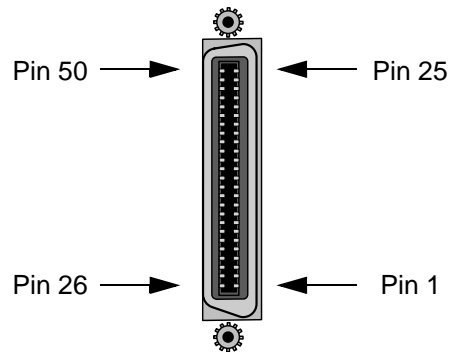

Figure C-55. FXO Coin Card Jack

Table C-54. FXO Coin Card Jack Pinouts

Port #	Designation	Pin #
1	T1	26
1	R1	1
2	T2	29
2	R2	4
3	T3	32
3	R3	7
4	T4	35
4	R4	10
5	T5	38
5	R5	13
6	T6	41
6	R6	16
7	T7	44
7	R7	19
8	T8	47
8	R8	22
All other pins are open.		

C.15 P-Phone Cards

C.15.1 P-Phone Cards PPO (813160) PPS (812160)

C.15.1.1 P-Phone External Card Connectors and Pinouts

The P-Phone PPO and PPS Cards provide a 25-pair Amphenol connector for the Tip and Ring connections of the eight ports. See Figure C-56 and Table C-55 for further details.

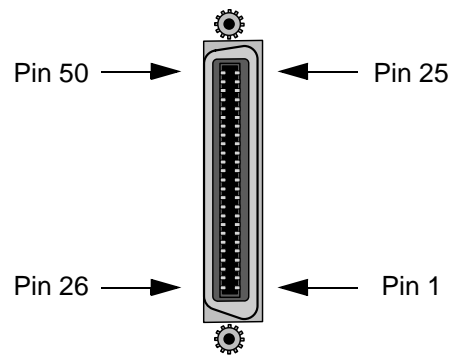

Figure C-56. P-Phone PPO and PPS Card Tip/Ring Connector

The user interface for both the PPO and the PPS Card is a standard 50-pin Telco connector. The wiring is identical to all other voice cards in that it uses assigned pairs 1, 4, 7, 10, 13, 16, 19 and 22 for the eight circuits. The interconnect cables used for voice cards may be used for the PPO and PPS.

Table C-55. P-Phone PPO and PPS Card Tip/Ring Connector Pinouts

Pin No.	Signal	Pin No.	Signal
1	R1	26	T1
2	nc	27	nc
3	nc	28	nc
4	R2	29	T2
5	nc	30	nc
6	nc	31	nc
7	R3	32	T3
8	nc	33	nc
9	nc	34	nc
10	R4	35	T4
11	nc	36	nc
12	nc	37	nc
13	R5	38	T5
14	nc	39	nc
15	nc	40	nc
16	R6	41	T6
17	nc	42	nc
18	nc	43	nc
19	R7	44	T7
20	nc	45	nc
21	nc	46	nc
22	R8	47	T8
23	nc	48	nc
24	nc	49	nc
25	nc	50	nc
nc = not connected			

Glossary

This Appendix lists the glossary of terms used in the telecommunications industry today.

AAL

ATM Adaption Layer

ABCD bits

The bits that carry signaling information over a T1 or E1 line.

ABR

Available Bit Rate

ACAMI

Alternate Channel AMI, transmitting data on every other DS0 in a DS1 to ensure ones-density.

ACO

Alarm Cutoff

ACS

Advanced Communications Server

ADPCM

Adaptive Differential Pulse Code Modulation

ADPCM Card

A resource card used to compress voice or subrate data on a DS0.

ADSL

Asymmetric Digital Subscriber Line

aggregate

A single bitstream combining many bitstreams of lower rates.

AIS

Alarm Indication Signal

AIS/ALM

Alarm Indication Signal/Alarm

AIM

ATM Inverse Multiplexer

a-law

E1 companding standard used in the conversion between analog and digital signals in PCM

ALIS

Analogue Line Interface Solutionsystems.

AMI

Alternate Mark Inversion, a line coding format for T1 lines.

ANI

Automatic Number Identification

ANSI

American National Standards Institute

ASCII

American Standard Code for Information Interchange

ASK

Amplitude Shift Keying

ATM

Asynchronous Transfer Mode

AWG

American Wire Gauge (the size of an electrical wire)

B7R

Bit #7 Redundant

B7R card

A network card used to provide Network Management capability for the system.

B8ZS

Bipolar 8-Zero Substitution, a coding scheme that maintains minimum-ones density on a T1 line.

Baud Rate

A measure of transmission speed over an analog phone line

B-channel

In ISDN, a full-duplex, 64 kbps ("bearer") channel that carries user data.

BECN

Backward Explicit Congestion Notification

BER

Bit Error Rate, the number of errored bits divided by the total number of bits.

BERT

Bit Error Rate Tester

BES

A Bursty Errored Second is any second with more than one and fewer than 320 CRC-6 (ESF), BPV (D4/D-frame), or CRC-4 (E1) errors

bit

Contraction of the words "binary" and "digit."

bps

Bits per second (not to be confused with Baud Rate)

BRI

Basic Rate Interface, (2B+D) in ISDN

BRITE

BRI Terminal Emulation

CAS

Channel-Associated Signaling, a means of conveying voice-circuit signaling over an E1 line.

CAS-CC

Channel Associated Signaling-Common Channel

CAS-BR

Channel Associated Signaling-Bit-robbing mode, used to convey voice-circuit signaling over a T1 line.

CBR

Constant Bit Rate

CCITT

Consultative Committee for International Telegraph and Telephone, now known as the ITU (International Telecommunications Union).

CCR

Current Cell Rate

CCS

Common Channel Signaling

CEP

Connection End Point

CEPT

Conference on European Posts and Telecommunications, a European standards organization.

CES

Circuit Emulation Service

CGA

Carrier Group Alarm, a condition that results from a network failure. Forces all voice circuits off-hook or on-hook until the alarm-causing condition is cleared and the CGA ends.

CLUE

Customer-Located Equipment

clear channel

A DS0 channel without formatting restrictions (i.e., uses the full 64 kbps bandwidth for data transmission).

CO

Central Office

channel bank

A device that places multiple voice and/or data channels onto a digital or analog carrier

CL

Connectionless Service

CPE

Customer Premises Equipment

CODEC

COder/DECOder (a device that encodes and decodes signals)

companding

Non-linear reduction of a signal, usually compressing the larger signal values

CRC

Cyclic Redundancy Check

CRC-4

CRC using four check bits

CRC-6

CRC using six check bits

CSA

Carrier Serving Area

CSC

Common Signaling Channel

CSU

Channel Service Unit, an interface to a T1 line that terminates the local loop.

CTE

Channel Terminating Equipment (Network)

CTS

Clear To Send, a lead on an interface indicating that the DCE is ready to receive data.

D4

A common T1 framing format, consisting of 12 frames. Also known as SF framing.

DACS

Digital Access and Cross-connect System (an electronic digital test access and patching system)

DCC

Data Communication Channel

DCE

Data Communications Equipment

DCS

Digital Cross-connect System

D-channel

Full-duplex, 16 kbps BRI channel or 64 kbps PRI ISDN channel.

DDS

Digital Data Service

d/i

Drop and Insert, one of the modes of operation for the WAN card.

DID

Direct Inward Dialing

DLC

Digital Loop Carrier

DLCI

Data Link Connection Identifier

DM

Degraded Minutes. Number of minutes with ES, UAS or LOS greater than zero (0).

DMA

Direct Memory Access

DPO

Dial-Pulse Originating

DPT

Dial-Pulse Terminating

DRAM

Dynamic Random Access Memory

DS0

Digital Signal - Zero, the standard bandwidth for digitized voice channels. Also referred to as a time slot.

DS0-A

Strategy for mapping a single low-speed data circuit to a single DS0.

DS0-B

Strategy for multiplexing two or more DS0-A low-speed data circuits onto a single DS0 (e.g., 5x9.6kbps, 10x4.8kbps or 20x2.4kbps).

DS0–DP Card

Digital Signal Zero–Dataport Card (one of the data cards for this system).

DS1

Digital Signal, Level 1

DSL

Digital Subscriber Line

DSR

Data Set Ready

DSX

Digital Signal Cross-connect

DTE

Data Terminal Equipment

DTR

Data Terminal Ready

DX

Duplex Signaling

E1

Digital 2.048 Mbps line rate, widely used in countries outside the U.S. and Canada.

EFCI

Explicit Forward Congestion Indicator

ELAN

Emulated Local Area Network

EPROM

Electronic Programmable Read-Only Memory, stores firmware on plug-in modules of the system.

ES

Errored Seconds. The number of seconds for which BRI card has detected a NEBE or FEBE greater than zero (0).

ESF

Extended Superframe (24-frame sequence for a T1 line; consists of two superframes)

ESS

Electronic Switching System

E&M

Earth and Magnetic, or recEive and transMit. The signaling leads on inter-switch voice connections.

E&M Card

An E&M voice card for this system.

ETS1

European Telecommunications Standards Institute

F4

Four-frame multiframe structure used in T1 signals.

FAS

Frame Alignment Signal

FCC

Federal Communications Commission

FDL

Facility Data Link, consists of every other framing bit of an extended T1 superframe. The FDL is used to convey performance data, line test/loopback status, and other parameters for an ESF-framed T1 line. The FDL rate is 4 kHz.

FE1

Fractional E1

FEBE

Far End Block Error, shows transmission errors detected by the far end equipment

FOTS

Fiber Optics Transmission Systems

frame

A delineated assembly of information, consisting of one sequence of 24 encoded channel samples (T1) or 32 channel samples (E1).

FRAD

Frame Relay Assembler/Disassembler, a card used in this system.

FRS

Frame Relay Server, a card used in this system.

FS

Frame Signaling bits (T1 line).

FT

Frame Terminal bits (T1 line)

FT1

Fractional T1

FUNI

Frame User Network Interface

FX

Foreign Exchange, a line that goes from a CO or PBX beyond the PBX or the CO's normal service area.

FXO

Foreign Exchange - Office, performs analog to digital and digital to analog transmission at the CO.

FXO Card

One of the voice cards for this system

FXS

Foreign Exchange - Subscriber or Station, an interface at the end of an FX line connected to a telephone or PBX. Performs digital to analog and analog to digital transmission at the station end.

FXS Card

One of the voice cards for this system

Ground

A physical connection to the earth, chassis, or other reference point

HDB3

High-Density Bipolar Order of 3, three-zero maximum coding for E1 lines. Provides a fourth zero violation for data bytes.

HDLC

High-Level Data Link Control (bit-oriented protocol)

HDSL

High-bit rate Digital Subscriber Line

hlink

A proprietary format for subrate data when using the ADPCM card.

HSU Card

High-Speed Unit Card (one of the data cards for this system).

HMI

Host Management Interface

HOM

HDSL OEM Module

ICMP

Internet Control Message Protocol

IEC

Interexchange Carrier (also called **IXC**)

IMUX

Inverse Multiplexer

IMUX Card

A resource card that gives users access to the ISDN network for bandwidth-on-demand applications.

inverted a-law

A variation of a-law encoding that provides a higher ones density on E1 lines.

IP

Internet Protocol

IPR

Internet Protocol Router

ISP

Internet Service Provider

ITU

International Telecommunications Union (previously known as CCITT [Consultative Committee for International Telegraph and Telephone])

ITU-T

International Telecommunications Union, Technical sector

IXC

Interexchange Carrier (also called **IEC**)

Kbps

Kilobits per second

LAN

Local Area Network

LANE

LAN Emulation

loopback

Path for returning a signal back to the point of origin for circuit testing

LOS

Loss Of Synchronization. Shows the number of seconds for which the BRI card detects LOS.

LSB

Least Significant Bit

LT

Line Termination

LULT

LT Like Unit

LUNT

NT Like Unit

MAC

Media Access Control

MBS

Nortel's Meridian Business Set. An electronic telephone set capable of handling the Meridian Digital Centrex features offered by DMS SuperNode Switch.

Mbps

Megabits per second

MDC

Meridian Digital Centrex

modem

Contraction of the words “modulator” and “demodulator”

MRD

Manual Ringdown

MSP

Maintenance Service Provider

MTS

Memory Time Switch

MTU

Maximum Transfer Unit

mu-law

T1 companding standard used in the conversion between analog and digital signals in PCM systems.

NEBE

Near End Block Error. Shows transmission errors detected by the near end equipment

Network card

A CPU card, Resource card, or WAN card used in this system.

NMS

Network management system, a computer used to control networks from a single location.

NNI

Network Node Interface

NOS

No-Signal Alarm

NRZ

Non-Return-to-Zero signal format

NT

Network Termination

NTU

Network Termination Unit, connects BRI station equipment to the integrated access system. Any standard 2B1Q (U interface) device that supports "nailed-up" (one or two B-channels) connections with no D-channel signaling.

OCU-DP Card

Office Channel Unit - Dataport (one of the data cards for this system).

OOF

Out Of Frame, an indication that the system is searching for the framing bit pattern in the signal received from the network.

OOS

Out of Service, an indication that a system element has failed.

OSI

Open Systems Interconnection

PAM

Pulse Amplitude Modulation

PBX

Private Branch Exchange, a small phone switch inside a company.

PCM

Pulse Code Modulation

PDU

Protocol Data Unit

ping

A program used to test IP-level connectivity from one IP address to another.

PLAR

Private Line Automatic Ringdown

PLR

Pulse Link Repeater

POP

Point of Presence, usually a telephone carrier office.

POTS

Plain Old Telephone Service

PPO

PPhone Foreign Exchange Office card. An interface at the end of the FX line connected to DMS SuperNode Switch.

PPP

Point-to-Point Protocol

PPS

PPhone Foreign Exchange Station Card. An interface at the end of the FX line connected to MBS.

protocol

Procedure or set of rules for communication between two devices.

PSTN

Public Switched Telephone Network.

PTT

Postal, Telephone, and Telegraph authority

PVC

Permanent Virtual Circuit

QAM

Quadrature Amplitude Modulation

RAI

Remote Alarm Indication

Red alarm

A local alarm on a T1 line, indicating that a major failure has occurred at this location.

robbed-bit

A type of analog signaling that occasionally “robs” information bits to convey encoded voice-circuit signaling.

RZ

Return-to-Zero signal format

SAP

Service Access Point

SES

Severly Errored Seconds

SF

Superframe, a T1 framing format consisting of 12 frames. Also known as D4 framing.

SLC[®]

Subscriber Loop Carrier (made by Lucent Technologies, one example of a Digital Loop Carrier (DLC) System.

SLIP

Serial Line Internet Protocol

SMDS

Switched Multimegabit Data Service

SNMP

Simple Network Management Protocol

SONET

Synchronous Optical Network

SRU Card

Subrate Unit Card (one of the data cards for this system).

system

Often used as a synonym for the integrated access system.

TA

Terminal Adapter

TE

Terminal Equipment

T1

The North American DS1 transmission rate, 1.544 Mbps.

TAD

Test Access Digroup

TCP/IP

Transmission Control Protocol/Internet Protocol

TDM

Time-Division Multiplexing

TELNET

An application protocol offering virtual terminal service in the Internet suite of protocols.

time slot map

Specification of the connections between all incoming and outgoing lines connected to the system. A cross-connect map allows users to split the bandwidth of T1 and E1 lines into amounts more suitable for normal voice and data communications.

TS

Time Slot

TSA

Time Slot Assigner

UART

Universal Asynchronous Receiver/Transmitter

UAS

Unavailable Seconds. Incremented by 10 when LOS has remained for more than 10 consecutive seconds and incremented by 1 every second until LOS is removed.

UDP

User Datagram Protocol

UI

Unit Interval

UNI

User Network Interface

User card

A Voice card, Data card, or Alarm card.

VBR

Variable Bit Rate

VC

Virtual Channel

VCL

Virtual Channel Link

VP

Virtual Path

VPC

Virtual Path Connection

WAN

Wide Area Network

WAN Card

Wide Area Network Card (one of the cards for this system).

wideband

A bandwidth equal to many individual channels

X.50

CCITT (ITU) standard data transmission protocol.

yellow alarm

Remote alarm on a T1 line. A major failure has occurred at a remote location.

ZCS

Zero Code Suppression