

IMACS Integrated Access System Alarm Cards Reference Guide

May 2008
Document Part Number: 830-01717-02

Release 6.0.0



Z H O N E TM

Zhone Technologies
@Zhone Way
7001 Oakport Street
Oakland, CA 94621
USA
510.777.7000
www.zhone.com
info@zhone.com

COPYRIGHT ©2000-2008 Zhone Technologies, Inc. and its licensors. All rights reserved.

This publication is protected by copyright law. No part of this publication may be copied or distributed, transmitted, transcribed, stored in a retrieval system, or translated into any human or computer language in any form or by any means, electronic, mechanical, magnetic, manual or otherwise, or disclosed to third parties without the express written permission from Zhone Technologies, Inc.

Bitstorm, EtherXtend, IMACS, MALC, MXK, Raptor, SLMS, Z-Edge, Zhone, ZMS, zNID and the Zhone logo are trademarks of Zhone Technologies, Inc.

Zhone Technologies makes no representation or warranties with respect to the contents hereof and specifically disclaims any implied warranties of merchantability, non infringement, or fitness for a particular purpose. Further, Zhone Technologies reserves the right to revise this publication and to make changes from time to time in the contents hereof without obligation of Zhone Technologies to notify any person of such revision or changes.

Product Description

The Alarm Cards allow the system to report alarms to external alarm annunciators and other systems. Each card also receives alarms reported by external devices. Each card has switches for outbound alarms, and sensors that detect incoming alarms from the external equipment.

Alarm Cards

- ALR ALR 4+4 (840160), ALR 4+3PF (840260), ALR 28+14 (840360)

Using this Alarm Card Reference Guide

This Alarm Card Reference Guide assists technicians with switch settings, connector pinouts, configuration, and troubleshooting information for the Alarm Cards.

Chapter 1. *Alarm Card*

Contents

Chapter 1 Alarm Cards

1.1	Introduction	1-1
1.2	Alarm Card Descriptions	1-1
1.2.1	ALR 4+4 Card Description (840160).....	1-1
1.2.1.1	Card Jumpers/Switch Settings.....	1-2
1.2.2	ALR 4+3PF Card Description (840260)	1-3
1.2.2.1	Card Jumpers/Switch Settings.....	1-3
1.2.3	ALR 28+14 Card Description (840360).....	1-4
1.2.3.1	Card Jumpers/Switch Settings.....	1-5
1.2.3.2	Installing the Alarm Card.....	1-8
1.3	Alarm Card User Screens and Settings	1-9
1.3.1	Alarm Filter Screen Sensor Setting	1-9
1.3.2	ALR 4+4 and ALR 4+3PF Card Main Screens.....	1-10
1.3.3	ALR 28+14 Card Screens and Settings	1-12
1.3.4	Alarm Sensor Screen	1-12
1.3.5	Alarm Switch Screen.....	1-14
1.3.6	Voice Screen.....	1-17
1.4	Alarm Card Error Messages	1-21
1.5	Alarm Card Troubleshooting	1-21

Contents

Figures

1-1	ALR 4+4 Card	1-2
1-2	ALR 4+3PF Card	1-3
1-3	ALR 28+14 Card Settings.....	1-4
1-4	Active and Passive Alarm Sensor Modes	1-6
1-5	Jumper Pair Assignments.....	1-7
1-6	Jumper Installation for Active Mode	1-7
1-7	Jumper Installation for Passive Mode.....	1-8
1-8	Alarm Filter Screen.....	1-9
1-9	ALR 4+4 and ALR 4+3PF Card Main Screen.....	1-10
1-10	ALR 28+14 Alarm Sensor Screen	1-12
1-11	ALR 28+14 Alarm Switch Screen	1-14
1-12	ALR 28+14 Voice Screen.....	1-17

Figures

Tables

1-1	ALR 4+4 and ALR 4+3PF Card Main Screen Actions	1-10
1-2	ALR 4+4 and ALR 4+3PF Card Option Settings and Defaults	1-11
1-3	ALR 28+14 Alarm Sensor Screen Actions.....	1-13
1-4	ALR 28+14 Alarm Sensor Option Settings and Defaults.....	1-13
1-5	ALR 28+14 Alarm Switch Screen Actions	1-15
1-6	ALR 28+14 Alarm Switch Option Settings and Defaults	1-15
1-7	ALR 28+14 Voice Screen Actions	1-17
1-8	ALR 28+14 Voice Option Settings and Defaults	1-18

Chapter 1

Alarm Cards

1.1 Introduction

This chapter provides installation, configuration, and troubleshooting information for the Alarm cards. These cards are labeled as the ALR 4+4, ALR 4+3PF, and ALR 28+14 Cards on their faceplate ejectors.

The Alarm cards allow the system to report alarms to external alarm annunciators and other systems. Each card also receives alarms reported by external devices. Each card has switches for outbound alarms, and sensors that detect incoming alarms from the external equipment.

Only one Alarm card can reside in the Integrated Access System at a time. These cards are discussed below.

Each card has two alarm notification modes. The "Switch/Act On" (outbound) function allows you to report internal system alarms to external devices, such as buzzers, bells, and lights. The "Sensor/Trig On" (inbound) function allows you to receive external alarms through sensors on the card.

1.2 Alarm Card Descriptions

1.2.1 ALR 4+4 Card Description ()

The ALR 4+4 Card has four outbound alarm switches and four inbound alarm sensors. The outbound switches report internal alarms to external devices by triggering form-C relay contact closures (120 VAC, 0.5A). The inbound sensors report external alarms to the system. All external alarms reported by sensors are listed in the alarm history file.

An Integrated Access System with an ALR 4+4 Card can respond to four external alarms for control of environmental and security conditions, and also provide four internal alarms to outside alarm indicators. For example, a critical alarm can illuminate a red light at the office.

Each inbound alarm sensor has the capability of responding to one external condition. The alarms appear on the screen in the alarm section, showing the alarm as a SENSOR alarm and includes the slot number and sensor number of the condition (e.g., SENSOR U7-4).

The inbound alarm sensors can use either 12V or 48V. Both JP1 and JP2 jumpers should be set for the proper voltage. The inbound sensors are isolated from ground.

Each outbound "floating" relay has normally open contacts and normally closed contacts. It responds to major, critical, minor, and informational alarms, and activates an external device. Two relays are provided for each Alarm Card port. The relays are dual-pole, double-throw.

1.2.1.1 Card Jumpers/Switch Settings

The US/Euro jumper pair on the ALR 4+4 card must be configured to the same setting as that of the chassis. The factory default setting for cards and chassis is **US** position.

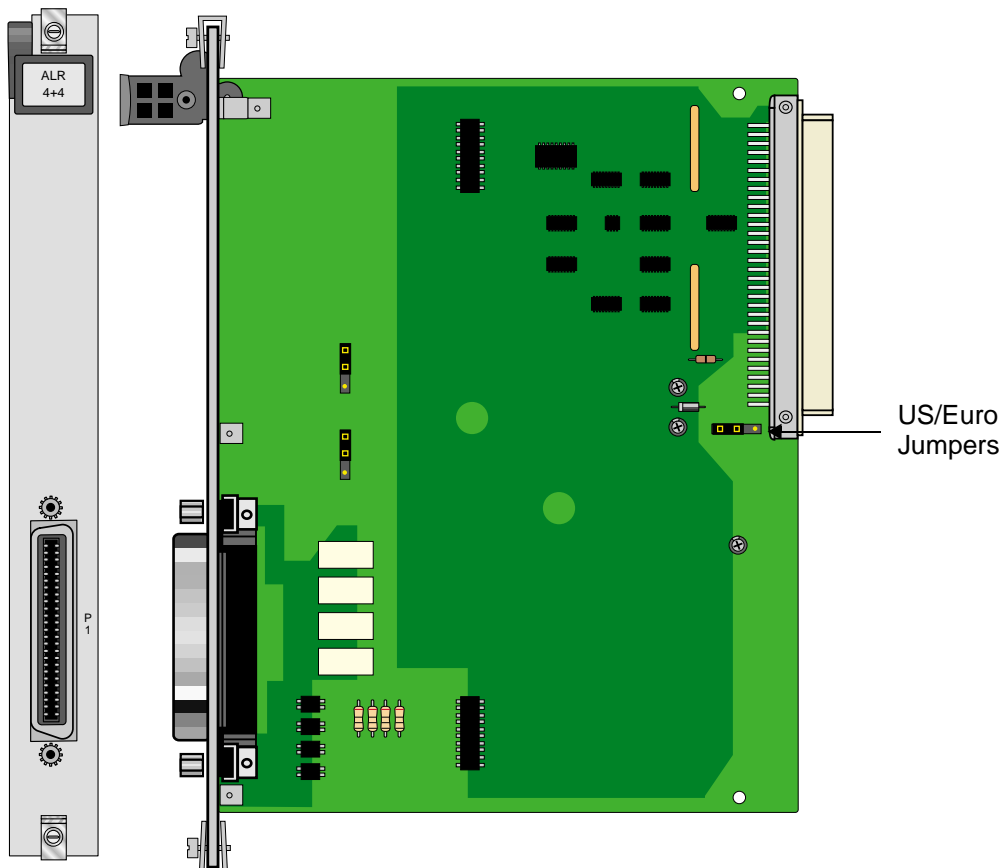

Figure 1-1. ALR 4+4 Card

1.2.2 ALR 4+3PF Card Description ()

The ALR 4+3PF Card has four outbound switches and three inbound sensors. This card is similar to the ALR 4+4 Card, except that its fourth alarm port can only be used as an **outbound** alarm to show the system power unit has failed. The ALR 4+3PF Card is especially helpful in locations where a loss of power to any system units is a critical problem. See Figure 1-2.

A -48 VDC power source is optional with this card. It may be provided by either an AC-to-DC Converter or an external source.

1.2.2.1 Card Jumpers/Switch Settings

There are US/EURO jumper settings with the ALR 4+3PF card.

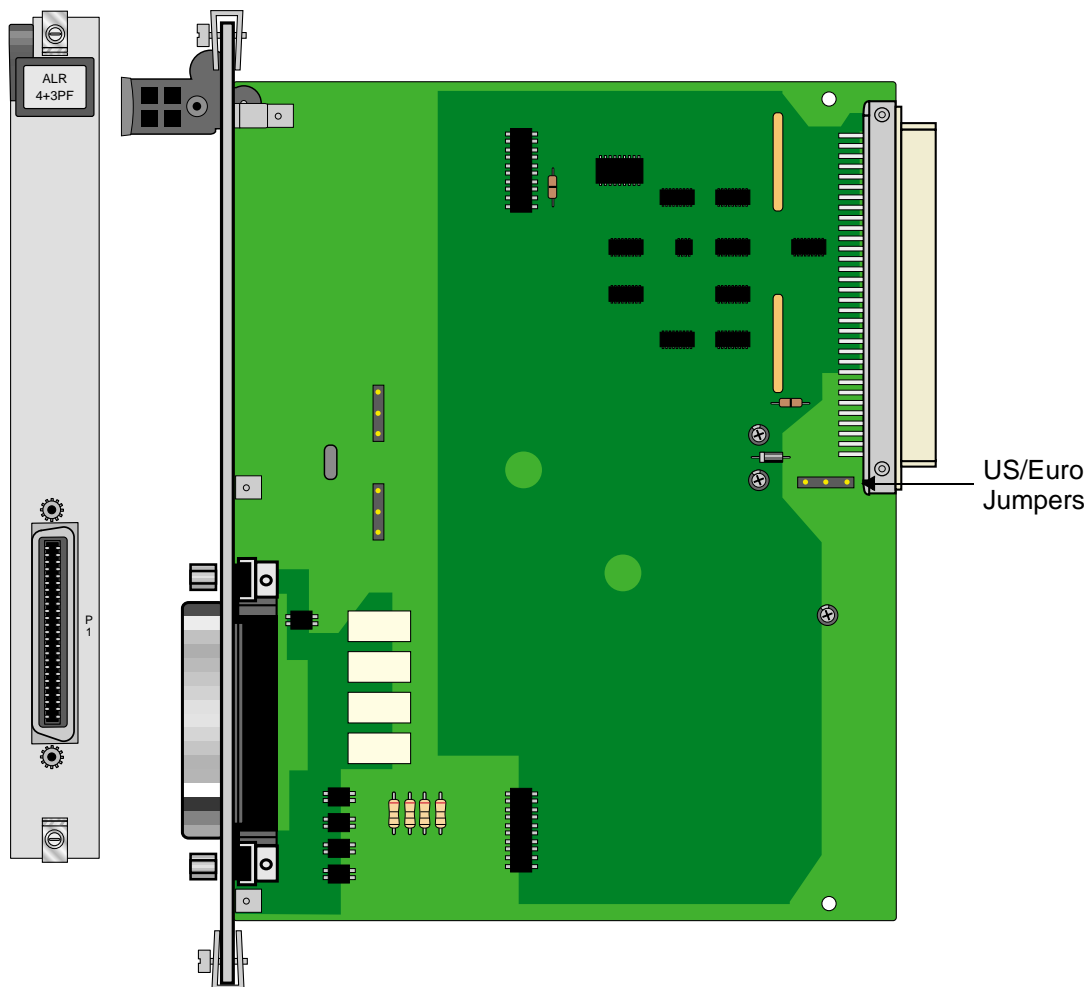

Figure 1-2. ALR 4+3PF Card

1.2.3 ALR 28+14 Card Description ()

The ALR 28+14 Card has 28 sensors for incoming external alarms. Each sensor controls its own alarm. The card also uses 14 switches to control external devices, and provides a single FXS voice port.

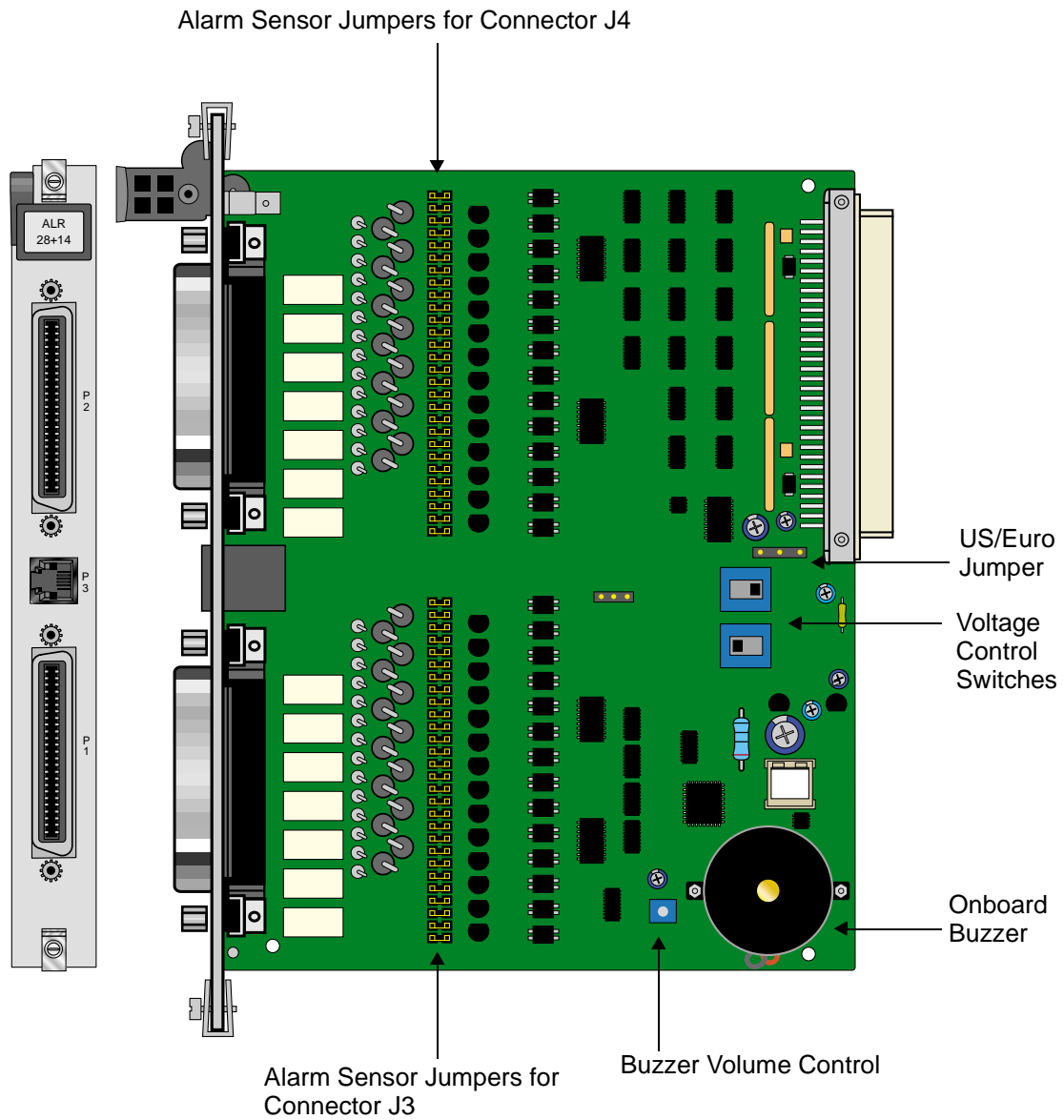

Figure 1-3. ALR 28+14 Card Settings

1.2.3.1 Card Jumpers/Switch Settings

The ALR 28+14 Card has numerous jumper and other settings, as shown in Figure 1-3. The sensors allow you to connect up to 28 external devices to the card. These sensors may be powered either externally or from the alarm card. They are divided into two groups, with 14 sensors per group. Each sensor group is routed through one of two Amphenol jacks, and you can control the voltage to each group by operating a voltage control switch on the alarm card. Detailed instructions for sensor control are provided later in this chapter.

The switches allow the card to control up to 14 external devices. As with the sensors, the switches are divided between the two Amphenol connectors into two groups of seven switches each. Twelve of the switches are Form C (open or closed based on user input), one is Form A (always open), and one is Form B (always closed). One of the switches can also be set to trip if a system power failure occurs. Instructions for switch control are provided later in this chapter.

The alarm information can also be transmitted to a central site via SNMP or other user-defined parameters.

Audible Alarm Buzzer Volume Setting

The ALR 28+14 Card has an on-board buzzer for audible alarms. You can set the buzzer to activate when a particular sensor detects an incoming alarm. The buzzer volume is set by a control dial marked VOL, which you can adjust with a small screwdriver.

U.S./European Voltage Jumpers

You can configure the ALR 28+14 Card for either U.S. or European operation by moving the jumpers located on JP64. One jumper is provided for each alarm sensor on the card. Inserting a jumper on the left-side two pins selects U.S. voltages. Inserting the jumper on the right-side two pins selects European voltages. All jumpers should be set to the same position, and this setting should match the configuration of the system chassis for the card to work properly. The factory default jumper setting is **US**.

Voltage Control Switches

Use switches S1 and S2 to control the voltage supplied to each group of active sensors. When either switch is set to SYS, the board supplies +12 and -12 VDC power to the sensor group associated with that Amphenol connector. When a switch is set to BAT, the ALR 28+14 Card supplies external telco power to the sensors in that group.

You can set the switches individually (i.e., one can be set to SYS and the other to BAT). However, this will affect all 14 sensors in the respective group.

Switch S1 controls the sensors on the J3 (lower) connector, and switch S2 controls the sensors on the J4 (upper) connector.

The factory default setting for the voltage control switches is **SYS**.

Alarm Sensor Jumpers

Each sensor is associated with a pair of jumpers that control whether the sensor is powered from the card (active mode) or an external device (passive mode). The passive mode provides 2500V of isolation. Figure 1-4 shows these options.

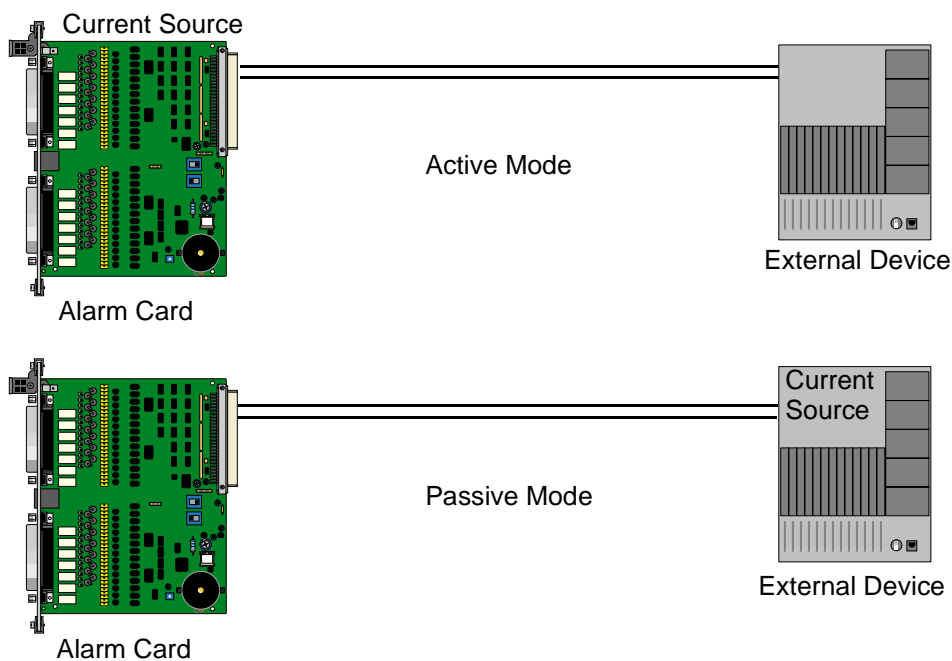

Figure 1-4. Active and Passive Alarm Sensor Modes

The jumpers are separated into two groups of 14 jumper pairs. The upper group is associated with the sensors on the upper amphenol connector (J4), and the lower group is associated with the sensors on the lower amphenol connector (J3). The jumper pair assignments are silk-screened on the card. The jumpers for sensor 1 are indicated as SI1, and the jumpers for sensor 28 are indicated as SI28. One of these sensor groups is detailed in Figure 1-5.

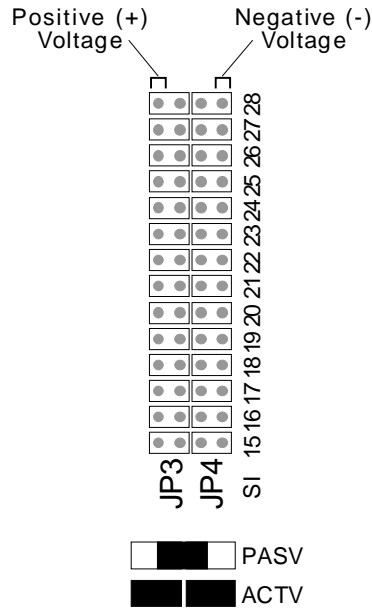

Figure 1-5. Jumper Pair Assignments

The outside pin of each jumper pair carries a voltage, while the inside pins are passive. The outside (left) pins for the jumper pairs in columns JP1 and JP3 carry positive (+) voltages, and the outside (right) pins for the jumper pairs in columns JP2 and JP4 carry negative (-) voltages.

The default setting for all jumper pairs is the active mode, as shown in Figure 1-6. The sensors are powered by the ALR 28+14 Card. This setting provides surge protection for the sensors.

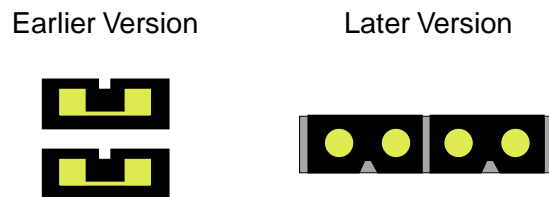

Figure 1-6. Jumper Installation for Active Mode

To set the jumper pair to the passive mode, remove both jumpers and then place a single jumper across the pair, as shown in Figure 1-7. This provides full isolation (to 2500V) for the sensor.

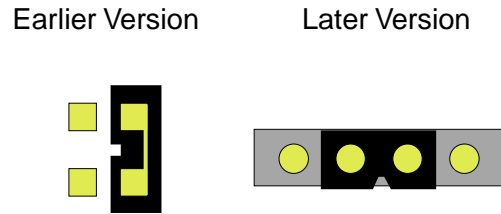

Figure 1-7. Jumper Installation for Passive Mode

The jumper pairs that correspond to each sensor are numbered accordingly. For example, the jumper pairs for sensor 12 are in row SI12 of the lower jumper group (columns JP1 and JP2). Similarly, the jumper pairs that correspond to sensor 25 are in row SI25 of the upper jumper group (columns JP3 and JP4).

Power Failure Notification

If a system power failure occurs, switch 1 can act as a fail-safe switch to activate a device that notifies an operator. For this to occur, you must install a jumper on jumper pair JP63 near the center of the card. The contact for switch 1 will close if the system loses power, establishing a circuit that can be used to power an external warning device. The current source must be provided by the external device.

1.2.3.2 Installing the Alarm Card

The Alarm card can be installed in any user card slot. These slots are U1 to U8 on the two-sided chassis and front-loading chassis with power supplies on top, and P1 to P4 or W1 to W4 on the front-loading chassis with power supplies on the side.

1.3 Alarm Card User Screens and Settings

1.3.1 Alarm Filter Screen Sensor Setting

First, make sure the master setting for all alarm sensors is set properly as the **SENSOR** variable in the Alarm Filter Screen. To set this variable, first select **Alarms** from the System Main Screen, then choose **Filters**. This will display a list of alarm filters, as shown in Figure 1-8.

In this menu, use the arrow keys to highlight the first column of the **SENSOR** line. Pressing <Enter> displays the options **ignore**, **log**, and **report**. The option chosen here will act as the highest-level option for all alarm card sensors. If this variable is set to **ignore**, *any alarm conditions on the alarm card will be ignored*, even if you set them up individually to **log** or **report**.

Likewise, if you set this variable to **log**, all sensors on the Alarm card that are set to anything other than **ignore** will be logged but not reported. For this reason, it is crucial that the **SENSOR** variable be set to **report** (see Figure 1-8).

unknown		1	2	3	10-04-99 17:06
OOS	Out of Service	log	major	acc-off	
NOS	No Signal	log	minor	acc-off	
LOS	Loss of Sync	log	minor	acc-off	
YEL	Yellow Alarm	log	minor	acc-off	
AIS	Alarm Info Signal	log	minor	acc-off	
CGA_RED	Carrier Group - Red	log	major	acc-off	
CGA_YEL	Carrier Group - Yellow	log	major	acc-off	
EER	Excessive Error Rate	ignore	minor	acc-off	
SENSOR	Alarm card sensor	log	minor	acc-off	
DCHAN	D-chan out of service	ignore	minor	acc-off	
SWITCH	Switch to redundant card	report	major	acc-off	
UCA	User card/port alarm	ignore	minor	acc-off	
RESET	System reset	report	major	acc-off	
ACO	Alarm Cut-Off	log	minor	n/a	
SYNC	Clock Sync Alarm	ignore	minor	acc-off	
EER-3	Error rate above 10e-3	ignore	minor	acc-off	
PLC_OOF	DS3 PLCP Out of Framing	ignore	minor	acc-off	
PLC_LOF	DS3 PLCP Loss of Frame	ignore	minor	acc-off	
PLC_YEL	DS3 PLCP Yellow Alarm	ignore	minor	acc-off	

Save | Undo | Refresh | Main

Figure 1-8. Alarm Filter Screen

1.3.2 ALR 4+4 and ALR 4+3PF Card Main Screens

Figure 1-9 shows the ALR 4+4 and ALR 4+3PF Card Main Screen. To go to this screen, highlight the Alarm card in the System Main Screen and press <Enter>.

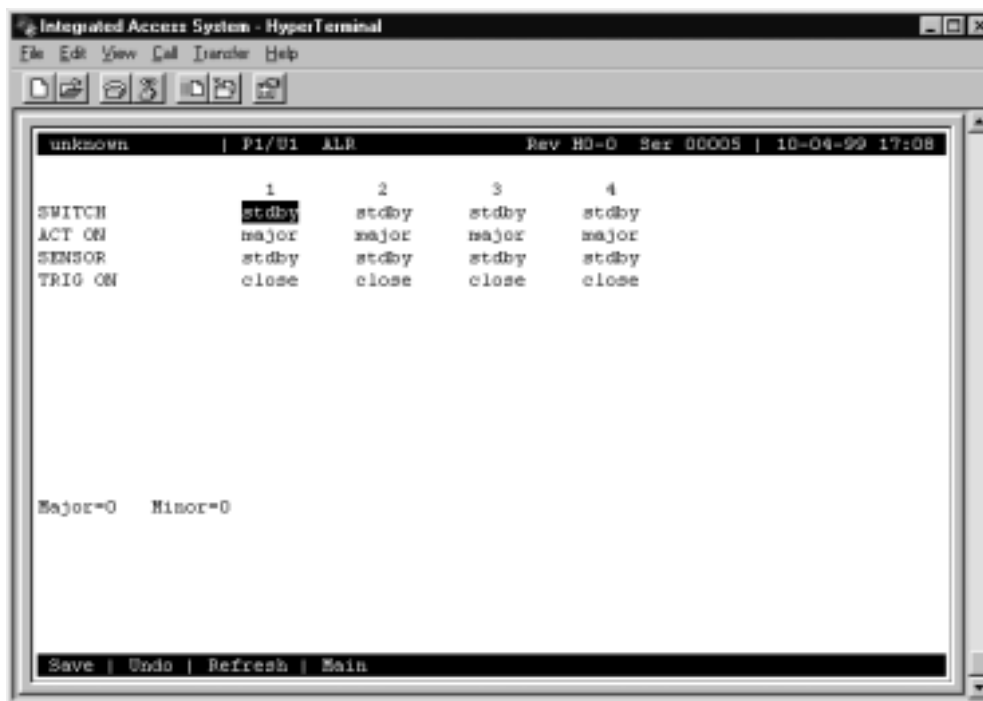

Figure 1-9. ALR 4+4 and ALR 4+3PF Card Main Screen

The bottom highlighted line of the screen shows several actions that you can perform from this screen. To perform an action, simply press the uppercase letter on your keyboard that corresponds to the desired action. Table 1-1 lists these actions, and Table 1-2 summarizes the card configuration option settings and default values. Each parameter is also described in the following paragraphs.

Table 1-1. ALR 4+4 and ALR 4+3PF Card Main Screen Actions

Action	Function
Save	Saves changes to settings.
Undo	Returns all settings to the last saved state.
Refresh	Updates certain time-related information fields that are not automatically updated on screen (i.e., alarm data).
Main	Returns to the System Main Screen. If changes are made to settings and not saved, you will be prompted to save or lose changes.

Table 1-2. ALR 4+4 and ALR 4+3PF Card Option Settings and Defaults

Parameter	User Options	Default
SWITCH	stdby actv	stdby
ACT ON	minor major any	minor
SENSOR	stdby actv	stdby
TRIG ON	close open	close

SWITCH

The Switch setting indicates that the outbound alarm switch is **actv** (on) or **stdby** (off).

ACT ON

The Act On parameter defines the type of system alarm that will cause the switch to trigger. Program each alarm switch to trigger on **minor** (information and minor) alarms, **major** (major and critical) alarms, or **any** alarm message.

SENSOR

The Sensor setting indicates the inbound alarm sensor is **actv** (on) or **stdby** (off).

TRIG ON

The Trigger On parameter defines if the sensor should report an external alarm upon sensing the opening (**open**) or the closure (**close**) of the C-form contact to which it is connected.

MAJOR =

The Major = accumulation register shows the current number of reported alarms designated as Major or Critical.

MINOR =

The Minor = accumulation register shows the current number of reported alarms designated as Minor or Informational.

1.3.3 ALR 28+14 Card Screens and Settings

1.3.4 Alarm Sensor Screen

Figure 1-10 shows the first (page 1) of three Alarm Sensors Screen for the ALR 28+14 Card. These are the main screens for that card. The first two screens each list 10 sensors, and the third screen similarly lists 8 sensors. You must give each sensor a name that corresponds to the incoming alarm, then set each variable for every sensor as described in this section.

The screenshot shows a terminal window titled "Integrated Access System - HyperTerminal". The main display area shows the following text:

```

unknown | P1/U1 ALR Rev HD-0 Ser 00005 | 10-04-99 17:10
page: 1 of 3
ALARM SENSORS
# SENSOR NAME TRIG ON STATUS ALARM TYPE BUZZER
1 [REDACTED] close ignore info off
2 close ignore info off
3 close ignore info off
4 close ignore info off
5 close ignore info off
6 close ignore info off
7 close ignore info off
8 close ignore info off
9 close ignore info off
10 close ignore info off
Refresh | dEfault | pgUp | pgDn | sWitches | Voice | Main

```

Figure 1-10. ALR 28+14 Alarm Sensor Screen

The bottom highlighted line of the screen shows several actions that you can perform from this screen. To perform an action, simply press the uppercase letter on your keyboard that corresponds to the desired action. For example, to go to the next screen page, type **u** (**pgUp** command). Table 1-3 lists these actions, and Table 1-4 lists the configuration option settings and default values. These parameters are described in the following paragraphs.

Table 1-3. ALR 28+14 Alarm Sensor Screen Actions

Action	Function
Refresh	Redraws the screen.
dEfault	Returns all settings to the default state.
pgUp	Returns to the previous screen page.
pgDn	Goes to the next screen page.
sWitches	Displays the Alarm Switch Screen.
Voice	Displays the Voice Screen.
Main	Returns to the System Main Screen. If changes are made to settings and not saved, you will be prompted to save or lose changes.

Table 1-4. ALR 28+14 Alarm Sensor Option Settings and Defaults

Parameter	User Options	Default
#	[Alarm Sensor number 1-28]	fixed
SENSOR NAME	[user-input sensor name]	blank
TRIG ON	close open	close
STATUS	ignore log report	ignore
ALARM TYPE	info minor major crit	minor
BUZZER	off on	off

SENSOR NAME

A user input field of up to six (6) characters to identify the specific alarm. Note that the sensor name is a local identifier, and is not transmitted with alarm conditions.

TRIG ON

The Trigger On parameter defines if the sensor should report an external alarm upon sensing the opening (**open**) or the closure (**close**) of the contact to which it is connected. The default value is **close**.

STATUS

This value indicates what action should be taken in the event of an alarm for each individual sensor. This variable may be set to **log** the alarm in the alarm register, or to **report** the alarm. Reported alarms are also logged by the system. The default value is **ignore**.

ALARM TYPE

This user-definable parameter indicates the severity of the incoming alarm. The options are **info**, **minor**, **major**, and **crit**. The default value is **minor**.

BUZZER

This variable indicates whether the on-board buzzer should be activated when the sensor indicates an alarm. The default value is **off**.

1.3.5 Alarm Switch Screen

Figure 1-11 shows the first of two Alarm Switch Screens. Each screen (page) lists seven switches. To go to this screen, press “w” (**sWitches** command) in the Alarm Sensor Screen.

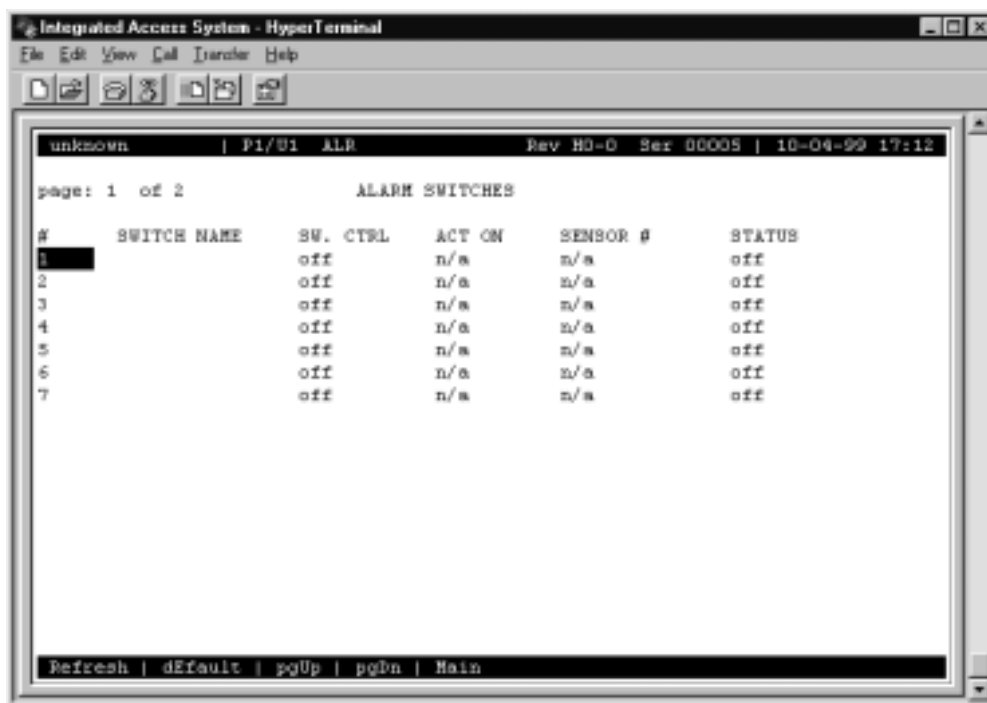

Figure 1-11. ALR 28+14 Alarm Switch Screen

The bottom highlighted line of the screen shows several actions that you can perform from this screen. To perform an action, simply press the uppercase letter on your keyboard that corresponds to the desired action. For example, to go to the next screen page, press “u” (**pgUp** command). Table 1-5 lists these actions, and Table lists the configuration option settings and defaults for the alarm switches. These parameters are described in the following paragraphs.

Table 1-5. ALR 28+14 Alarm Switch Screen Actions

Action	Function
Refresh	Updates certain time-related information fields that are not automatically updated.
dEfault	Returns all settings to the default states.
pgUp	Returns to the previous page.
pgDn	Goes to the next page.
Main	Returns to the Alarm Sensor Screen.

Table 1-6. ALR 28+14 Alarm Switch Option Settings and Defaults

Parameter	User Options	Notes	Default
#	Alarm Switch number 1 to 14		fixed
SsWITCH Name	User-defined switch name		blank
SW. CTRL	off on act_on		act_on
ACT ON	info minor major crit sensor		major
SENSOR #	n/a 1 to 28	1	n/a
STATUS	off on		displayed

Notes:

1. Sensor numbers are assignable only if the ACT ON parameter is set to sensor number 1 to 28. The default setting is 1.

SWITCH NAME

A user-defined field up to six characters identifies the specific switch. Note that the switch name is a local identifier; it is not transmitted with alarm conditions.

SW. CTRL

This variable indicates the initial state of the switch. The possibilities are **off** (which unconditionally turns the switch off), **on** (which unconditionally turns the switch on) or **act_on** (which relies on the state of the switch). The default value is **off**.

As mentioned previously, 12 of the switches are Form C (which may be either open or closed), one is Form A (always open), and one is Form B (always closed).

In the event of system power failure, switch 1 can be used as a fail-safe switch to activate a device that notifies the user. In order for this to occur, a jumper must be set on jumper pair JP63, located towards the center of the card. The contact for switch 1 will close if the system loses power, establishing a circuit that can be used to power an external warning device. The current source must be provided by the external device.

ACT ON

This parameter defines the condition that will cause the switch to trigger. You can program each alarm switch to trigger on **info**, **minor**, **major**, or **crit** alarms. Alternatively, the switch trigger can also be assigned to a particular **sensor**. When **sensor** is selected, **SENSOR #** allows you to indicate the number of the sensor that will trigger the alarm. The default value is **major**.

SENSOR #

When the ACT ON field is set to **sensor**, you can enter a value from **1** to **28**, indicating the number of the sensor that will trigger the switch. The default value is **n/a**.

STATUS

This is a display-only field; you cannot edit it.

1.3.6 Voice Screen

An RJ-11 FXS voice port is located on the ALR 28+14 Card between the two Amphenol connectors. The initial Voice Screen for this port is shown in Figure 1-12. To go to this screen, press “v” (**Voice** command) in the Alarm Sensor Screen.



Figure 1-12. ALR 28+14 Voice Screen

The bottom highlighted line of the screen shows several actions that you can perform from the Voice Screen. To perform an action, simply press the uppercase letter on your keyboard that corresponds to the desired action. Table 1-7 lists these actions, and Table 1-8 summarizes the configuration option settings and default values. These parameters are described in the following paragraphs.

Table 1-7. ALR 28+14 Voice Screen Actions

Action	Function
Save	Saves changes to settings.
Undo	Returns all settings to the last saved state.
Refresh	Updates certain time-related information fields that are not automatically updated on the screen (e.g., alarm data).
Main	Returns to the Alarm Sensor Screen. If changes are made to settings and not saved, you will be prompted to save or lose changes.

Table 1-8. ALR 28+14 Voice Option Settings and Defaults

Parameter	User Options	Default
STATE	stdby actv	stdby
WAN/SRV	none w1-1 through w4-2	none
TS	1 to 24 1 to 31	n/a
MODE	fxs plar	fxs
TYPE	loop d3-m1 d4-m1 d3-m2 d4-m2 d3-m3 d4-m3	loop
RX tlp	-10.0 to +2.0	-5.0
TX tlp	-10.0 to +5.0	2.0
coding	u-law a-inv a-law	u-law
ringbk	off on	off

STATE

The State setting determines whether the port is active or inactive. An inactive port does not occupy a time slot on a WAN link. Set the State setting to **stdby** (standby) for ports you are not using or have not yet configured. Set it to **actv** (active) for ports that are ready for use. The default value is **stdby**.

WAN/SRV

The WAN setting identifies the WAN link assigned to this port. The default value is **none**.

TS

The TS setting identifies the time slot on the WAN link to which this port is assigned. Values range from **1** to **24** for T1 links and **1** to **31** for E1 links. Time slot 16 is not available on E1 links that are programmed for **cas** or **ccs** signaling. For a display of the available time slots, refer to your cross-connect map for the WAN link. The default value is **n/a**. See Chapter 4, *System Configuration and Operation* for more information regarding cross-connect maps.

MODE

The Mode setting should be determined by the type of equipment to which you are connecting the port. All options use two-wire balanced connections. The **fxs** (Foreign Exchange - Station) option allows you to connect a telephone to the system.

The **plar** (private line automatic ringdown) option provides point-to-point unswitched connections between two telephone sets. This configuration is usually not attached to an exchange or switch; rather, it provides a “hot line” between two locations.

TYPE

The Type setting matches the signaling behavior of the FXS equipment and the remote switch. The **loop** (Loop-start) option, which is used with POTS stations and simple PBX trunks, is only available when the MODE setting is **fxs**. If the MODE setting is **plar**, the TYPE options are **d3-m1**, **d4-m1**, **d3-m2**, **d4-m2**, **d3-m3**, and **d4-m3**.



CAUTION!

Before activating this port, verify the behavior expected by both the station and remote central office equipment, and make sure the system is properly configured.

Rx TL

The Receive Transmission Level Point setting controls the amount of gain or attenuation added to signals after they are decoded to analog signals. To increase the signal level, set the RX TLP setting to a positive number (i.e., the larger the number, the more gain is added). To decrease the signal level, set the RX TLP setting to a negative number (i.e., the more negative the number, the more the signal level is decreased). For example, an incoming signal at -5 dBm can be increased to -3 dBm by setting RX TLP to +2 dB. Acceptable values range from **-10.0 dB** to **+2.0 dB**. The default value is **-5.0**.

Tx TLP

The Transmit Transmission Level Point setting controls the amount of gain or attenuation added to signals after they are received from the local analog port and before they are encoded to digital PCM signals. To increase the signal level, set the TX TLP setting to a negative number (i.e., the more negative the number, the more gain is added). To decrease the signal level, set the TX TLP setting to a positive number (i.e., the more positive the number, the more the signal level is decreased). For example, an incoming signal at -5 dBm can be increased to -2 dBm by setting TX TLP to -3 dB. Acceptable values range from **-10.0 dB** to **+5.0 dB**. The default value is **+2.0**.

CODING

The Coding setting sets the PCM companding method used for a port. In general, in the T1/North American environment use **μ-law** coding. In the E1/International environment, use **a-inv** (inverted A-law) or **a-law** coding; **a-inv** provides greater 1s density than **a-law**. The coding default is determined by the type of card in the WAN port you select. The default value is **u-law** (Note: On the system screens, "u" is used in place of "μ" because of ASCII character limitations, but should be read as "mu-law.").

RINGBK

The ringback setting specifies whether a ringback tone is generated by the system and sent towards the network. This option should be turned on when the network does not provide an audible ringing tone to the calling party. The default value is **off**.

1.4 Alarm Card Error Messages

Refer to Appendix B in the System Reference Guide for further information on Error Messages regarding this card.

1.5 Alarm Card Troubleshooting

Alarm card problems could indicate a number of possible causes. Typically, a problem is indicated by the loss of an incoming alarm signal on a sensor port or the lack of a contact closure/open in response to an internal alarm. Steps designed to isolate the source of the problem and return the card to normal operation are detailed below. When troubleshooting Alarm card problems, you should follow this general sequence:

1. Verify that the US/EUR jumper is correctly positioned on the Alarm card to match the US/EUR jumper on the chassis. Also verify that the voltage level selected is the same on JP1 and JP2.
2. Verify that the Alarm card sensor filter (SENSOR) is set to either **log** or **report** in the Alarm Filters Menu. This menu is accessed by selecting "Alarms" from the Main Screen (not the Alarm Card Screen), and then selecting "Filters." Column 1 lists the filter setting (ignore, log, or report). You can change the filter setting by highlighting the item you wish to change and pressing the <Enter> key. Use the arrow keys to highlight a new filter setting and press the <Enter> key again. If you are satisfied with your selections, remember to "Save" before exiting the screen. If you make any changes and then attempt to exit the screen without saving, you will be prompted "Ok to lose changes (y/n)?" You must select "y" or "n". If you select "y", any changes will be lost and all selections will revert to the last saved state.
3. On the Alarm card menu, verify that the switch/sensor in question is set to active (**actv**). If set correctly and the problem is with a switch (contact), go to step 4. If the problem is with a sensor, go to step 6.
4. Verify that the amphenol cable is connected correctly to the Alarm card. At a cross-connection point between the Alarm card and the external "scan point", open the circuit under test. Connect a Volt-Ohmmeter set to read resistance across the Alarm card contact in question. If no alarm of the type (Major, Minor or Any) that the contact is programmed to act upon is present, and it is a normally open (NO) contact, the meter will read infinite resistance. If you are testing a normally closed (NC) contact, the meter will read 0 ohms resistance.
5. Generate an alarm of the type (Major, Minor or Any) that the contact is programmed to act upon. The Volt-Ohmmeter should detect a resistance change from 0 to infinite or infinite to 0, depending on the type of contact (NO or NC). If no change is detected, the switch port may be defective.

6. Verify the amphenol cable is connected correctly to the Alarm card. At a cross-connection point between the Alarm card and the external equipment, open the circuit under test. Connect a short across the Alarm card sensor input in question. A SENSOR alarm should be reported. If no alarm is reported, the sensor port may be defective.

7. If the Alarm card is determined to be faulty, replace it and return the faulty unit for repair to the location specified by your distributor.



Note: Refer to the Alarm Card Filters table located in the System Configuration and Operation Chapter of the System Reference Manual.